

PRESSURE, VACUUM, DIFFERENTIAL PRESSURE AND TEMPERATURE SWITCHES

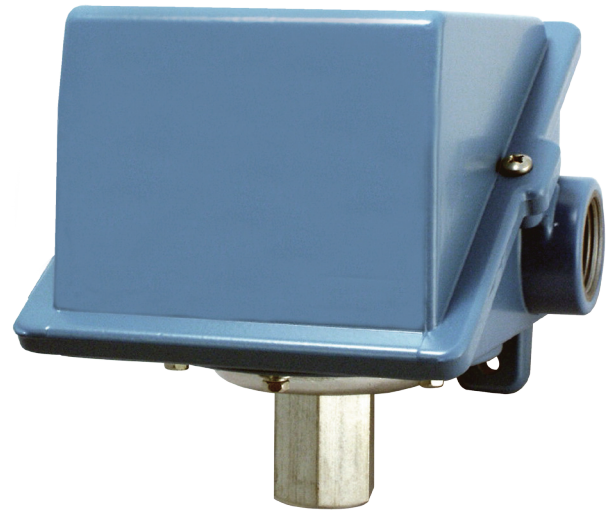

FEATURES

- 1, 2 & 3 switch outputs
- Epoxy-coated enclosure designed to meet enclosure type 4X
- Wide variety of pressure sensors and materials
- Setting via reference dial or hex screw adjustment
- FM approved
- Adjustable Ranges:

"WC ranges: 300 "wc vacuum to 250 "wc pressure (-746,7 to 622,3 mbar)

Pressure: 30 "Hg Vac to 6000 psi (-1,0 to 413,7 bar)

Differential pressure: 1" wcd to 200 psid (2.5 mbar to 13,8 bar)

Temperature: -180 to 650 °F (-117.8 to 343.3 °C)





OVERVIEW

The 400 Series is a versatile family of vacuum, pressure, differential pressure and temperature switches for applications that require single or multiple switching capabilities. Dual and triple switch versions provide multi-output for alarm and shutdown, pre-alarm and alarm, high/low limit or level staging functions.

A wide variety of microswitch and process connection options, along with a weather-tight enclosure, make the 400 Series an ideal choice for most ordinary location applications. Its worldwide use is assured with approvals and certifications to agency standards.

Widely used throughout the process industries, the 400 Series provides threshold protection and control for many critical functions. Typical installations are found in industrial gas production, energy generation including pumps, turbines and compressors, pulp and paper, and water and wastewater treatment.

FEATURES

- UL listed and cUL certified. FM approved.
- CE compliant to low voltage directive and pressure equipment directive.
- Optional ATEX or GOST intrinsic safety compliance.
- One, two or three switch outputs may be separated up to 100% of range.
- Wide variety of available options and pressure sensor modules.
- Most models available for immediate delivery.



Reference scale, for types B, E & H with option M321

Enlarged View

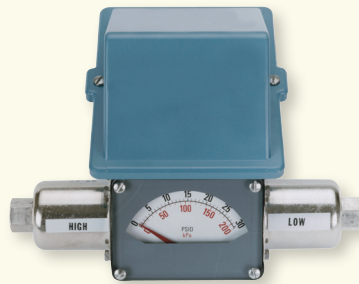

Differential Pressure Model with M210 Option - Dial Indication

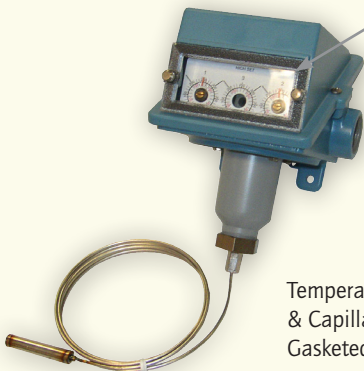

Temperature Model with Remote Bulb & Capillary and M321 option - Gasketed Lexan® Window

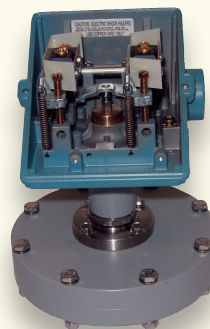

Dual Switch, Low Water Column Differential Pressure Model

SPECIFICATIONS

STORAGE TEMPERATURE	-65 to 160°F (-54 to 71°C)
AMBIENT TEMPERATURE LIMITS	-40 to 160°F (-40 to 71°C); set point typically shifts less than 1% of range for a 50°F (28°C) ambient temperature change
SET POINT REPEATABILITY	Temperature models: ± 2% of full scale range Pressure: models 126-376, 520-535, 540-547, 570-572, S126B-S164B: ± 2% of full scale range; models 440-457, 550-559: ± 1% of full scale range; models 610-614: ± 3% of full scale range
SHOCK	Set point repeats after 15 G, 10 millisecond duration
VIBRATION	Set point repeats after 2.5 G, 5-500 Hz
ENCLOSURE	Die cast aluminum, epoxy powder coated, gasketed, captive cover screws
ENCLOSURE CLASSIFICATION	Designed to meet enclosure type 4X requirements
SWITCH OUTPUT	One, two or three SPDT switches, may be separated up to 100% of range except models 521-524, 531-534: 50%; models 520, 525, 530, 535, 570-572: 30%; switches may be wired "normally open" or "normally closed"
ELECTRICAL RATING	15 A 125/250/480 VAC resistive. Electrical switches have limited DC capabilities. Consult factory for additional information.
WEIGHT	Approx. 3 to 7.5 lbs.; varies with model
ELECTRICAL CONNECTION	One 3/4" NPT and two 7/8" diameter knockouts
PRESSURE CONNECTION	All models 1/4" NPT (female) except models S126B-S164B, 520-535: 1/2" NPT (female); models 540-547: 1/8" NPT (female)
TEMPERATURE ASSEMBLY	'E' types use the same assemblies as 'F' types, however, range spans are limited due to use of reference dials Bulb and capillary: 6 feet 304 stainless steel Immersion stem: models 120 & 121: nickel-plated brass; optional 316L stainless steel available
FILL	Temperature Models: Model 1BS: solvent filled; models 2-8: non-toxic oil filled
TEMPERATURE DEADBAND	Type F typically 1% and type E, B & C typically 2% of range under laboratory conditions (70°F ambient circulating bath at rate of 1/2°F per minute change)
DIFFERENTIAL PRESSURE INDICATOR (OPTION M210)	Differential pressure indication available J400K, J402K models 147-S157B; accuracy approximately 1-1/2% mid 50% of range, 3% at ends; window is plexiglass and gasketed; indicator may be field adjusted for approximately ±1% accuracy at any set point within range

APPROVALS



UNITED STATES AND CANADA

Type 400 & 402

UL Listed, cUL Certified

Pressure: UL 508; CSA C22.2 No. 14, file # E42272

Temperature: UL 873; CSA C22.2 No. 24, file # E10667



Type 403

UL Recognized, cUL Recognized

Pressure: UL 508; CSA C22.2 No. 14, file # E42272

Temperature: UL 873; CSA C22.2 No. 24, file # E10667



All Types

FM Approved

Pressure: Class 3510

Temperature: Class 3545

Canadian Registration Number (CRN): Refer to www.ueonline.com/certifications for list of approved models



EUROPE

ATEX Directive (94/9/EC)

II 1 G EEx ia IIC T6 (OPTIONAL - code M405)

Tamb = -50°C to +60°C

UL International DEMKO A/S (N.B.# 0539)

Certificate # DEMKO 03 ATEX 0335063

EN 50014, 50020 & 50284



Low Voltage Directive (LVD) (73/23/EC & 93/68/EEC)

Compliant to LVD

Products rated lower than 50 VAC and 75 VDC are outside of the scope of the LVD

Pressure Equipment Directive (PED) (97/23/EC)

Compliant to PED

Products rated below 7.5 PSI are outside the scope of PED



RUSSIA

Gosgortekhnadzor Permit (OPTIONAL - code M406)

0ExialICT6

Tamb = -50°C to +60°C

NANIO CCVE Certification Center

Certificate # ROSS US.GB05.Bo2933

GOST R 51330.0, 51330.1, 51330.10 & 51330.14

PRESSURE MODEL CHART

Type J400, single switch output with internal hex screw adjustment
 Type J402, dual switch output with internal hex screw adjustment
 Type J403, triple switch output with internal hex screw adjustment

Model	Adjustable Set Point Range		Deadband		Over Range Pressure*		Proof Pressure**	
	Low end of range on fall; High end of range on rise "wc	mbar	Deadband doubles for 2 and 3 switch types "wc	mbar	psi	bar	psi	bar
Buna-N diaphragm and O-Ring with epoxy coated aluminum 1/2" NPT (female) pressure connection, large 0.72" orifice for clean-out purposes. Other wetted materials available, see pg. 12								
520†	300 Vac to 0	-746,7 to 0	0.2 to 12	0,5 to 29,9	200	13,8	400	27,6
521†	10 Vac to 10	-24,9 to 24,9	0.1 to 1	0,2 to 2,5	200	13,8	400	27,6
522†	50 Vac to 50	-124,5 to 124,5	0.1 to 5	0,2 to 12,4	200	13,8	400	27,6
523†	0.5 to 5.0	1,2 to 12,4	0.1 to 0.3	0,2 to 0,7	200	13,8	400	27,6
524†	2.5 to 50	6,2 to 124,5	0.1 to 2	0,2 to 5,0	200	13,8	400	27,6
525†	10 to 250	24,9 to 622,3	0.1 to 10	0,2 to 24,9	200	13,8	400	27,6
Welded 316L stainless steel diaphragm and 1/2" NPT (female) pressure connection, large 0.72" orifice for clean-out purposes								
530†	300 Vac to 0	-746,7 to 0	0.2 to 15	0,5 to 37,3	50	3,4	100	6,9
531†	10 Vac to 10	-24,9 to 24,9	0.1 to 1	0,2 to 2,5	50	3,4	100	6,9
532†	50 Vac to 50	-124,5 to 124,5	0.1 to 6	0,2 to 14,9	50	3,4	100	6,9
533†	0.5 to 5.0	1,2 to 12,4	0.1 to 0.3	0,2 to 0,7	50	3,4	100	6,9
534†	2.5 to 50	6,2 to 124,5	0.1 to 2.5	0,2 to 6,2	50	3,4	100	6,9
535†	10 to 250	24,9 to 622,3	0.1 to 10	0,2 to 24,9	50	3,4	100	6,9
	psi (unless noted)	bar (unless noted)	psi (unless noted)	bar (unless noted)	psi (unless noted)	bar (unless noted)	psi	bar
316L stainless steel diaphragm and Viton® O-Ring with 316L stainless steel 1/4" NPT (female) pressure connection								
570 ¹	0 to 20	0 to 1,4	0.2 to 4	13,8 to 275,8 mbar	20	1,4	225	15,5
571 ¹	0 to 50	0 to 3,4	0.7 to 6	48,3 to 413,7 mbar	50	3,4	225	15,5
572 ¹	0 to 100	0 to 6,9	1 to 7	0,1 to 0,5	100	6,9	225	15,5
Welded 316L stainless steel bellows and 1/2" NPT (female) pressure connection								
S126B	30 "Hg Vac to 0	-1 to 0	0.2 to 0.9 "Hg	6,8 to 30,5 mbar	3	0,2	5	0,3
S134B	30 "Hg Vac to 20 psi	-1 to 1,4	0.2 to 1.2 "Hg	6,8 to 40,6 mbar	20	1,4	25	1,7
S137B	0 to 80 "wc	0 to 199,1 mbar	2 to 6 "wc	5 to 14,9 mbar	80 "wc	199,1 mbar	5	0,3
S144B	0 to 20	0 to 1,4	0.1 to 0.5	6,9 to 34,5 mbar	20	1,4	25	1,7
S146B	0 to 30	0 to 2,1	0.1 to 0.6	6,9 to 41,4 mbar	30	2,1	40	2,8
S156B	0 to 100	0 to 6,9	0.2 to 0.8	13,8 to 55,2 mbar	100	6,9	125	8,6
S164B	0 to 200	0 to 13,8	0.3 to 2	20,7 to 137,9 mbar	200	13,8	200	13,8
Welded 316L stainless steel bellows and 1/4" NPT (female) pressure connection								
358	0 to 200	0 to 13,8	1.5 to 8	0,1 to 0,6	200	13,8	250	17,2
361	0 to 300	0 to 20,7	2 to 9	0,1 to 0,6	300	20,7	350	24,1
376	0 to 500	0 to 34,5	3 to 12	0,2 to 0,8	500	34,5	575	39,6

*Over Range Pressure: The maximum pressure that may be applied continuously without causing damage and maintaining set point repeatability
 **Proof pressure: The maximum pressure to which a pressure sensor may be subjected, which causes no permanent damage. The unit may require calibration (e.g. start-up, testing).

† Model not available on types J400 and J403; actual deadband shown, do not double – switch separation a maximum of 30 - 50% of range.

¹Switch separation of 30% maximum for dual and triple switch units.



400 Series

400 Series

PRESSURE MODEL CHART

Type J400, single switch output with internal hex screw adjustment

Type J402, dual switch output with internal hex screw adjustment

Type J403, triple switch output with internal hex screw adjustment

Model	Adjustable Set Point Range		Deadband		Over Range Pressure*		Proof Pressure**	
	psi (unless noted)	bar (unless noted)	psi	bar	psi (unless noted)	bar	psi	bar
303 stainless steel piston with Buna-N O-Ring and 303 stainless steel 1/4" NPT (female) pressure connection (not recommended for gas service since drying of the O-Ring seal can allow bleeding of medium into the atmosphere)								
610	100 to 1,000	6,9 to 68,9	30 to 150	2,1 to 10,3	6,000	413,7	10,000	689,5
612	200 to 3,000	13,8 to 206,8	40 to 250	2,8 to 17,2	6,000	413,7	10,000	689,5
614	500 to 6,000	34,5 to 413,7	50 to 400	3,4 to 27,6	6,000	413,7	10,000	689,5
Brass bellows with nickel-plated brass 1/4" NPT (female) pressure connection; Models 126 and 134 have zinc-plated steel spring exposed to media								
126	30 "Hg Vac to 0	-1 to 0	0.2" to 0.9 "Hg	6,8 to 30,5 mbar	3	0,2	5	0,3
134	30 "Hg Vac to 20 psi	-1 to 1,4	0.2" to 1.2 "Hg	6,8 to 40,6 mbar	20	1,4	25	1,7
137	0 to 80 "wc	0 to 199,1 mbar	2 to 6 "wc	5 to 14,9 mbar	3	0,2	5	0,3
144	0 to 20	0 to 1,4	0.1 to 0.5	6,9 to 34,5 mbar	20	1,4	25	1,7
146	0 to 30	0 to 2,1	0.1 to 0.6	6,9 to 41,4 mbar	30	2	40	2,8
156	0 to 100	0 to 6,9	0.2 to 0.8	13,8 to 55,2 mbar	100	6,9	125	8,6
164	0 to 200	0 to 13,8	0.3 to 2	20,7 to 137,9 mbar	200	13,8	200	13,8
Phosphor bronze bellows with nickel-plated brass 1/4" NPT (female) pressure connection								
270	0 to 200	0 to 13,8	1.5 to 8	0,1 to 0,6	200	13,8	250	17,2
274	0 to 300	0 to 20,7	2 to 10	0,1 to 0,7	300	20,7	350	24,1
Buna-N diaphragm and O-Ring with aluminum 1/4" NPT (female) pressure connection and cap								
440††	0 to 2 "wc	0 to 5 mbar	0.07 to 0.25 "wc	0,2 to 0,6 mbar	3	0,2	225	15,5
441†††	0 to 10 "wc	0 to 24,9 mbar	0.15 to 0.3 "wc	0,4 to 0,7 mbar	3	0,2	225	15,5
442	0 to 20 "wc	0 to 49,8 mbar	0.2 to 0.5 "wc	0,5 to 1,2 mbar	3	0,2	225	15,5
443	0 to 80 "wc	0 to 199,1 mbar	0.5 to 1.8 "wc	1,2 to 4,5 mbar	3	0,2	225	15,5
448	80 "wc Vac to 0	-199,1 to 0 mbar	1 to 3 "wc	2,5 to 7,5 mbar	3	0,2	225	15,5
449†††	0 to 20 "wc	0 to 49,8 mbar	1 to 2 "wc	2,5 to 5,0 mbar	3	0,2	225	15,5
450	30 "Hg Vac to 0	-1 to 0	0.1 to 0.4 "Hg	3,4 to 13,5 mbar	3	0,2	225	15,5
451	0 to 80 "wc	0 to 199,1 mbar	1 to 3 "wc	2,5 to 7,5 mbar	3	0,2	225	15,5
452	30 "Hg Vac to 20 psi	-1 to 1,4	0.2 to 1 "Hg	6,8 to 33,9 mbar	20	1,4	225	15,5
453	0 to 20	0 to 1,4	0.05 to 0.2	3,4 to 13,8 mbar	20	1,4	225	15,5
454	0 to 30	0 to 2,1	0.05 to 0.3	3,4 to 20,7 mbar	30	2,1	225	15,5
Teflon® diaphragm and Viton® O-Ring with 316L stainless steel 1/4" NPT (female) pressure connection and cap								
550	30 "Hg Vac to 0	-1 to 0	0.1 to 0.6 "Hg	3,4 to 20,3 mbar	3	0,2	225	15,5
551	0 to 80 "wc	0 to 199,1 mbar	1.5 to 3.5 "wc	3,7 to 8,7 mbar	3	0,2	225	15,5
552	30 "Hg Vac to 20 psi	-1 to 1,4	0.2 to 1 "Hg	6,8 to 33,9 mbar	20	1,4	225	15,5
553	0 to 20	0 to 1,4	0.05 to 0.3	3,4 to 20,7 mbar	20	1,4	225	15,5
554	0 to 30	0 to 2,1	0.1 to 0.4	6,9 to 27,6 mbar	30	2,1	225	15,5
555	0 to 100	0 to 6,9	0.25 to 0.75	17,2 to 51,7 mbar	100	6,9	225	15,5

Teflon® and Viton® are registered trademarks of E.I. DuPont de Nemours and Company

†† Model not available on types J402 and J403

††† Model not available on type J403

PRESSURE MODEL CHART

Type H400, single switch output with internal adjustment via reference dial

Type H402, dual switch output with internal adjustment via reference dial

Type H403, triple switch output with internal adjustment via reference dial

Model	Adjustable Set Point Range		Deadband		Proof Pressure**		Scale Division
	psi (unless noted)	bar (unless noted)	psi (unless noted)	bar (unless noted)	psi	bar	psi (unless noted)
Welded 316L stainless steel bellows and 1/2" NPT (female) pressure connection							
S126B	30 "Hg Vac to 0	-1 to 0	0.2 to 0.9 "Hg	6,8 to 30,5 mbar	5	0,3	2 "Hg
S134B	30 "Hg Vac to 20 psi	-1 to 1,4	0.2 to 1.2 "Hg	6,8 to 40,6 mbar	25	1,7	2 "Hg & 2 psi
S137B†	0 to 80 "wc	0 to 199,1 mbar	2 to 6 "wc	5 to 14,9 mbar	5	0,3	5 "wc
S144B	0 to 20	0 to 1,4	0.1 to 0.5	6,9 to 34,5 mbar	25	1,7	1
S146B	0 to 30	0 to 2,1	0.1 to 0.6	6,9 to 41,4 mbar	40	2,8	1
S156B	0 to 100	0 to 6,9	0.2 to 0.8	13,8 to 55,2 mbar	125	8,6	5
S164B	0 to 200	0 to 13,8	0.3 to 2	20,7 to 137,9 mbar	200	13,8	10
Welded 316L stainless steel bellows and 1/4" NPT (female) pressure connection							
358	0 to 200	0 to 13,8	1.5 to 8	0,1 to 0,6	250	17,2	10
361	0 to 300	0 to 20,7	2 to 9	0,1 to 0,6	350	24,1	10
376	0 to 500	0 to 34,5	3 to 12	0,2 to 0,8	575	39,6	20
Brass bellows with nickel-plated brass 1/4" NPT (female) pressure connection; Models 126 and 134 have zinc-plated steel spring exposed to media							
126	30 "Hg Vac to 0	-1 to 0	0.2 to 0.9 "Hg	6,8 to 30,5 mbar	5	0,3	2 "Hg
134	30 "Hg Vac to 20 psi	-1 to 1,4	0.2 to 1.2 "Hg	6,8 to 40,6 mbar	25	1,7	2 "Hg & 2 psi
137†	0 to 80 "wc	0 to 199,1 mbar	2 to 6 "wc	5 to 14,9 mbar	5	0,3	5 "wc
144	0 to 20	0 to 1,4	0.1 to 0.5	6,9 to 34,5 mbar	25	1,7	1
146	0 to 30	0 to 2,1	0.1 to 0.6	6,9 to 41,4 mbar	40	2,8	1
156	0 to 100	0 to 6,9	0.2 to 0.8	13,8 to 55,2 mbar	125	8,6	5
164	0 to 200	0 to 13,8	0.3 to 2	20,7 to 137,9 mbar	200	13,8	10
Phosphor bronze bellows with nickel plated brass 1/4" NPT (female) pressure connection							
270††	0 to 200	0 to 13,8	1.5 to 8	0,1 to 0,6	250	17,2	10
274††	0 to 300	0 to 20,7	2 to 10	0,1 to 0,7	350	24,1	10
Buna-N diaphragm and O-Ring with aluminum 1/4" NPT (female) pressure connection and cap							
440†	0 to 2 "wc	0 to 5 mbar	0.07 to 0.25 "wc	0,2 to 0,6 mbar	225	15,5	0.1 "wc
441†	0 to 10 "wc	0 to 24,9 mbar	0.15 to 0.3 "wc	0,4 to 0,7 mbar	225	15,5	0.5 "wc
442†	0 to 20 "wc	0 to 49,8 mbar	0.2 to 0.5 "wc	0,5 to 1,2 mbar	225	15,5	1 "wc
443†	0 to 80 "wc	0 to 199,1 mbar	0.5 to 1.8 "wc	1,2 to 4,5 mbar	225	15,5	5 "wc
448†	80 "wc Vac to 0	-199,1 to 0 mbar	1 to 3 "wc	2,5 to 7,5 mbar	225	15,5	5 "wc
450††	30 "Hg Vac to 0	-1 to 0	0.1 to .04 "Hg	3,4 to 13,5 mbar	225	15,5	2 "Hg
452††	30 "Hg Vac to 20 psi	-1 to 1,4	0.1 to 1 "Hg	3,4 to 33,9 mbar	225	15,5	2 "Hg & 2 psi
453††	0 to 20	0 to 1,4	0.05 to 0.2	3,4 to 13,8 mbar	225	15,5	1
454††	0 to 30	0 to 2,1	0.05 to 0.3	3,4 to 20,7 mbar	225	15,5	1

**Proof pressure: The maximum pressure to which a pressure sensor may be subjected, which causes no permanent damage. The unit may require calibration (e.g. start-up, testing).

† Model not available on types H402 and H403

†† Model not available on type H403



PRESSURE MODEL CHART

Type H400, single switch output with internal adjustment via reference dial
 Type H402, dual switch output with internal adjustment via reference dial
 Type H403, triple switch output with internal adjustment via reference dial

Model	Adjustable Set Point Range		Deadband		Proof Pressure**		Scale Division
	psi (unless noted)	bar (unless noted)	psi (unless noted)	bar (unless noted)	psi	bar	psi (unless noted)
Teflon® diaphragm and Viton® O-Ring with 316L stainless steel 1/4" NPT (female) pressure connection and cap							
550††	30 "Hg Vac to 0	-1 to 0	0.1 to 0.6 "Hg	3,4 to 20,3 mbar	225	15,5	2 "Hg
552††	30 "Hg Vac to 20 psi	-1 to 1,4	0.2 to 1 "Hg	6,8 to 33,9 mbar	225	15,5	2 "Hg & 2 psi
553††	0 to 20	0 to 1,4	0.05 to 0.3	3,4 to 20,7 mbar	225	15,5	1
554††	0 to 30	0 to 2,1	0.1 to 0.4	6,9 to 27,6 mbar	225	15,5	1
555††	0 to 100	0 to 6,9	0.25 to 0.75	17,2 to 51,7 mbar	225	15,5	5

**Proof pressure: The maximum pressure to which a pressure sensor may be subjected, which causes no permanent damage. The unit may require calibration (e.g. start-up, testing).

† Model not available on types H402 and H403

†† Model not available on type H403

DIFFERENTIAL PRESSURE MODEL CHART

Type J400K, single switch output with internal hex screw adjustment
 Type J402K, dual switch output with internal hex screw adjustment

Model	Adjustable Set Point Range		Deadband		Working Pressure***		Proof Pressure**	
	psid (unless noted)	bar (unless noted)	psi (unless noted)	mbar	psi	bar	psi	bar
Welded 316L stainless steel bellows and 1/2" NPT (female) pressure connections								
S147B	3 to 30	0,2 to 2,1	0.5 to 2	34,5 to 137,9	30 "Hg Vac to 100	-1 to 6,9	300	20,7
S157B	10 to 100	0,7 to 6,9	0.5 to 3	34,5 to 206,8	30 "Hg Vac to 180	-1 to 12,4	300	20,7
Brass bellows with nickel-plated brass 1/4" NPT (female) pressure connections								
147	3 to 30	0,2 to 2,1	0.5 to 2	34,5 to 137,9	30 "Hg Vac to 100	-1 to 6,9	180	12,4
157	10 to 100	0,7 to 6,9	0.5 to 3	34,5 to 206,8	30 "Hg Vac to 150	-1 to 10,3	180	12,4
Buna-N diaphragm and O-Ring with aluminum 1/4" NPT (female) pressure connections								
455	5 to 80 "wcd	12,4 to 199,1 mbar	1 to 4 "wc	2,5 to 10	30 "Hg Vac to 225	-1 to 15,5	225	15,5
456	2 to 20	0,1 to 1,4	0.1 to 0.3	6,9 to 20,7	30 "Hg Vac to 225	-1 to 15,5	225	15,5
457	3 to 30	0,2 to 2,1	0.1 to 0.4	6,9 to 27,6	30 "Hg Vac to 225	-1 to 15,5	225	15,5

***Working Pressure Range: The pressure range within which two opposing sensors can be safely operated and still maintain set point adjustability.

DIFFERENTIAL PRESSURE MODEL CHART

Type J400K, single switch output with internal hex screw adjustment
 Type J402K, dual switch output with internal hex screw adjustment

Model	Adjustable Set Point Range		Deadband		Working Pressure***		Proof Pressure**	
	Low end of range on fall; High end of range on rise		Deadband doubles for 2 and 3 switch types					
	psid (unless noted)	bar (unless noted)	psi (unless noted)	bar (unless noted)	psi	bar	psi	bar
Buna-N diaphragms and o-ring with epoxy coated aluminum 1/8" NPT (female) pressure connections (J402K only)								
540†	1 to 7 "wcd	2.5 to 17,4 mbar	0.1 to 0.5"wc	0,2 to 1,2 mbar	30 "Hg Vac to 200	-1 to 13,8	400	27,6
541†	2 to 20 "wcd	5 to 49,8 mbar	0.5 to 2 "wc	1,2 to 5 mbar	30 "Hg Vac to 200	-1 to 13,8	400	27,6
542†	5 to 50 "wcd	12,4 to 124,5 mbar	0.5 to 5 "wc	1,2 to 12,4 mbar	30 "Hg Vac to 200	-1 to 13,8	400	27,6
543†	15 to 100 "wcd	37,3 to 248,9 mbar	0.5 to 7 "wc	1,2 to 17,4 mbar	30 "Hg Vac to 200	-1 to 13,8	400	27,6
544†	2 to 20	0,1 to 1,4	1 to 2.5	0,1 to 0,2	30 "Hg Vac to 1200	-1 to 82,7	2500	172,4
545†	5 to 50	0,3 to 3,4	1 to 3	0,1 to 0,2	30 "Hg Vac to 1200	-1 to 82,7	2500	172,4
546†	10 to 100	0,7 to 6,9	1 to 5	0,1 to 0,3	30 "Hg Vac to 1200	-1 to 82,7	2500	172,4
547†	20 to 200	1,4 to 13,8	1 to 7	0,1 to 0,5	30 "Hg Vac to 1200	-1 to 82,7	2500	172,4
Teflon® and Buna-N diaphragms, Buna-N O-Ring with aluminum 1/4" NPT (female) pressure connections								
559	10 to 100	0,7 to 6,9	0.2 to 1	13,8 to 68,9 mbar	30 "Hg Vac to 225	-1 to 15,5	225	15,5
Type H400K, single switch output with internal adjustment via reference dial Type H402K, dual switch output with internal adjustment via reference dial								
Buna-N diaphragm and O-Ring with 1/4" NPT (female) aluminum pressure connections								
455	5 to 80 "wcd	12,4 to 199,1 mbar	1 to 4 "wc	2,5 to 10 mbar	30 "Hg Vac to 225	-1 to 15,5	225	15,5
456	2 to 20	0,1 to 1,4	0.1 to 0.3	6,9 to 20,7 mbar	30 "Hg Vac to 225	-1 to 15,5	225	15,5
457	3 to 30	0,2 to 2,1	0.1 to 0.4	6,9 to 27,6 mbar	30 "Hg Vac to 225	-1 to 15,5	225	15,5
Teflon and Buna-N diaphragms, Buna-N O-Ring with 1/4" NPT (female) aluminum pressure connections								
559	10 to 100	0,7 to 6,9	0.2 to 1	13,8 to 68,9 mbar	30 "Hg Vac to 225	-1 to 15,5	225	15,5

***Working Pressure Range: The pressure range within which two opposing sensors can be safely operated and still maintain set point adjustability.
 † Model not available on type J400K; actual deadband shown, do not double



TEMPERATURE MODEL CHART

- Type B400, single switch output, immersion stem, internal adjustment via reference dial
- Type B402, dual switch output, immersion stem, internal adjustment via reference dial
- Type B403, triple switch output, immersion stem, internal adjustment via reference dial
- Type C400, single switch output, immersion stem, internal hex screw adjustment
- Type C402, dual switch output, immersion stem, internal hex screw adjustment
- Type C403, triple switch output, immersion stem, internal hex screw adjustment
- Type E400, single switch output, bulb & capillary***, internal adjustment via reference dial
- Type E402, dual switch output, bulb & capillary***, internal adjustment via reference dial
- Type E403, triple switch output, bulb & capillary***, internal adjustment via reference dial
- Type F400, single switch output, bulb & capillary***, internal hex screw adjustment
- Type F402, dual switch output, bulb & capillary***, internal hex screw adjustment
- Type F403, triple switch output, bulb & capillary***, internal hex screw adjustment

Model	Adjustable Set Point Range		Max. Temp.		Scale Division††		Stem or Bulb Size*/Finish**
	°F	°C	°F	°C	°F	°C	
Type B400, B402, B403, single, dual, or triple switch output, immersion stem, internal adjustment via reference dial.							
Type C400, C402, C403, single, dual, or triple switch output, immersion stem, internal hex screw adjustment							
120	0 to 225	-17.8 to 107.2	275	135	5	5	9/16" x 1-7/8" nickel-plated brass
121	200 to 425	93.3 to 218.3	475	246.1	5	5	9/16" x 1-7/8" nickel-plated brass
Type E400, E402, E403, single, dual, or triple switch output, bulb & capillary***, internal adjustment via reference dial							
2BSA	-120 to 100	-84.4 to 37.8	150	65.6	10	5	3/8 x 2-5/8"
2BSB	30 to 250	-1.1 to 121.1	300	148.9	10	5	3/8 x 2-5/8"
3BS	100 to 400	37.8 to 204.4	450	232.2	10	10	3/8 x 2-1/8"
4BS	25 to 100	-3.9 to 37.8	150	65.6	5	2	3/8 x 6-3/4"
5BS	-20 to 80	-28.9 to 26.7	130	54.4	5	2	3/8 x 5"
8BS	350 to 640	176.7 to 337.8	690	365.6	10	10	3/8 x 3-1/4"
Type F400, F402, F403, single, dual, or triple switch output, bulb & capillary***, internal hex screw adjustment							
1BS†	-180 to 120	-117.8 to 48.9	170	76.7	N/A		3/8 x 3-3/4"
2BS	-125 to 350	-87.2 to 176.7	400	204.4	N/A		3/8 x 2-5/8"
3BS	-125 to 500	-87.2 to 260	550	287.8	N/A		3/8 x 2-1/8"
4BS	-40 to 120	-40 to 48.9	170	76.7	N/A		3/8 x 6-3/4"
5BS	-40 to 180	-40 to 82.2	230	110	N/A		3/8 x 5"
6BS	0 to 250	-17.8 to 121.1	300	148.9	N/A		3/8 x 4-1/2"
7BS	0 to 400	-17.8 to 204.4	450	232.2	N/A		3/8 x 3"
8BS	50 to 650	10 to 343.3	700	371.1	N/A		3/8 x 3-1/4"

† Model not available on type F403
 †† Only applies to types B400, B402, B403, E400, E402 and E403
 * Optional immersion stem lengths and capillary lengths are available
 ** Optional stainless steel immersion stem and capillary covering available
 *** Standard capillary lengths are 6ft

HOW TO ORDER

BUILDING A PART NUMBER

Select a **Type**

Refer to the "Type" section below.

Determine type number based on switch output, enclosure, adjustment and reference.

Fill in the type portion of your part number with the corresponding number.

Select a **Model**

Refer to the "Model Charts".

Determine model based on adjustable range, deadband and proof pressure.

Fill in the model portion of your part number with the corresponding number.

Select an **Option**

Refer to the "Options" section.

Determine option number based on switch output, optional materials or other product enhancements.

Fill in the option portion of your part number with the corresponding number.

Leave "option" portion blank if no options are needed.

FOR MULTIPLE OPTIONS: Call United Electric Controls.

TYPE

DESCRIPTION

PRESSURE

- Type J400 - One SPDT output; internal hex screw adjustment
- Type J402 - Two SPDT outputs; internal hex screw adjustment
- Type J403 - Three SPDT outputs; internal hex screw adjustment
- Type H400 - One SPDT output; internal adjustment with reference dial
- Type H402 - Two SPDT outputs; internal adjustment with reference dial
- Type H403 - Three SPDT outputs; internal adjustment with reference dial

DIFFERENTIAL PRESSURE

- Type J400K - One SPDT output; internal hex screw adjustment
- Type J402K - Two SPDT outputs; internal hex screw adjustment
- Type H400K - One SPDT output; internal adjustment with reference dial
- Type H402K - Two SPDT outputs; internal adjustment with reference dial

TEMPERATURE

- Type B400 - Immersion stem; one SPDT output; internal adjustment with reference dial
- Type B402 - Immersion stem; two SPDT outputs; internal adjustment with reference dial
- Type B403 - Immersion stem; three SPDT outputs; internal adjustment with reference dial
- Type C400 - Immersion stem; one SPDT output; internal hex screw adjustment
- Type C402 - Immersion stem; two SPDT outputs; internal hex screw adjustment
- Type C403 - Immersion stem; three SPDT outputs; internal hex screw adjustment
- Type E400 - Bulb and capillary; one SPDT output; internal adjustment with reference dial
- Type E402 - Bulb and capillary; two SPDT outputs; internal adjustment with reference dial
- Type E403 - Bulb and capillary; three SPDT outputs; internal adjustment with reference dial
- Type F400 - Bulb and capillary; one SPDT output; internal hex screw adjustment
- Type F402 - Bulb and capillary; two SPDT outputs; internal hex screw adjustment
- Type F403 - Bulb and capillary; three SPDT outputs; internal hex screw adjustment



HOW TO ORDER OPTIONS

SWITCH OPTIONS* DESCRIPTION

0140	Gold contacts, 1 A 125 VAC resistive. NOT AVAILABLE MODELS 440-443
0500	Close deadband, 5 A 125/250 VAC resistive. NOT AVAILABLE MODELS 440-443, 520-535 & 540-547
1010	DPDT switch, 10 A 125/250 VAC resistive; deadband and minimum set point will increase. NOT AVAILABLE TEMPERATURE VERSIONS, TYPE J403, TYPE H403 AND MODELS 440-449, 520-535, 540-547, 570-572
1070	10 A 125 VDC resistive; deadband and minimum set point will increase. NOT AVAILABLE TYPES B, E AND MODELS 440-449, 520-535, 540-547, 570-572
1520	Adjustable deadband, 15 A 125/250/480 VAC resistive. Adjustment wheel changes rise setting only if adjustment on fall setting is required, use primary adjustment (see product Installation & Maintenance instructions for additional information or consult UE). NOTE: NOT AVAILABLE ON MIDDLE SWITCH FOR TYPE J403, C403 AND F403. NOT AVAILABLE TYPES B, E, H, OR MODELS 440-443, 520-535, 540-547, 570-572, 610-614
1530	External manual reset, 15 A 125/250/480 VAC resistive, latches on rise only. NOT AVAILABLE TRIPLE SWITCH VERSIONS, OR MODELS 440-443, 520-535, 570-572
1535	High ambient, 15 A 125/250/480 VAC resistive; temperatures up to 250°F/145°C. NOT AVAILABLE MODELS 440-443, 520-535
1537	Vapor-sealed 15 A 125/250 VAC resistive. NOT AVAILABLE MODELS 440-443, 520-535
1539	Fungus resistant case, 15 A 125/250 VAC resistive. NOT AVAILABLE MODELS 440-443, 520-535
2000	20 A 125/250/480 VAC resistive. NOT AVAILABLE MODELS 440-443, 520-535, 540-547, 570-572

OTHER OPTIONS

M020	Single red status light, 115 VAC only. Specify whether light goes on or off with increasing or decreasing pressure or temperature. NOT AVAILABLE J400K, H400K, J402K, H402K OR MODELS 440-443, 449
M201	Factory set one switch; specify set point on increasing or decreasing pressure, differential pressure or temperature. NOT AVAILABLE DUAL OR TRIPLE SWITCH VERSIONS
M202	Factory set two switches; specify set points on increasing or decreasing pressure, differential pressure or temperature. NOT AVAILABLE SINGLE OR TRIPLE SWITCH VERSIONS
M203	Factory set three switches; note: the third or middle switch must always be set to highest pressure or temperature when switches are set apart; specify set points on increasing or decreasing pressure, differential pressure or temperature. NOT AVAILABLE SINGLE OR DUAL SWITCH VERSIONS
M210	Differential pressure indication. AVAILABLE J400K AND J402K, MODELS 147, S147B, 157 & S157B
M277	Range indicated on nameplate in kPa or MPa, factory selected. NOT AVAILABLE TEMPERATURE VERSIONS
M278	Range indicated on nameplate in Kg/cm ² . NOT AVAILABLE TEMPERATURE VERSIONS
M321	Gasketed Lexan® window. NOT AVAILABLE ON J, C, F TYPES
M405	Intrinsic safety compliance for European Union per ATEX standards
M406	Intrinsic safety compliance for Russia per Gosgortekhnadzor standards
M444	Paper ID tag
M446	Stainless steel ID tag & wire attachment
M449	Surface mounting hardware kit that is required for models 520-535 when surface mounting. Use option code only at time of ordering product, otherwise use surface and pipe mounting kit part number 6361-704 as a separate order or for other models.
M504	316L Stainless steel immersion temperature stem. AVAILABLE TEMPERATURE MODELS 120, 121 ONLY
M540	Viton® construction (deadband and low end range may increase slightly); wetted parts include Viton® with standard connection material. AVAILABLE MODELS 448-454 and 540-547. TYPES J400K & J402K MODELS 455-457 include Viton® sealing diaphragms and O-rings with Teflon® main diaphragm. TYPES H400K & H402K MODELS 456-457 include Viton® sealing diaphragms and O-rings with Teflon® main diaphragm. MODELS 610-614 (Viton® O-ring only).
M550	Oxygen service cleaning; alcohol cleaning to remove residue from the process connection. NOT AVAILABLE ON MODELS 440-443 OR H400K-455 AND H402K-455.
M900	Watertight conduit fitting; converts 7/8" hole to 1/2" NPT fitting. Required for product to meet NEMA 4X if using knockout holes for wiring
M913	1/4" NPT (female) stainless steel pressure connection. AVAILABLE MODELS S126B-S146B, S156B, S164B ONLY
M914	1/2" NPT (female) stainless steel pressure connection. AVAILABLE MODELS 358-376
M921	1/4" NPT (female) brass pressure connection. AVAILABLE MODELS 610-614, TYPE J402 ONLY
6361-704	Surface and pipe mount hardware kit for all models. Required for surface mounting needs 520-535, if not previously ordered with option M449.
SD6286-51	Watertight conduit fitting; connects 7/8" hole to 1/2" NPT (female) fitting, if not previously ordered with option M900

**All switches have limited DC capabilities. Consult factory for details.*

HOW TO ORDER OPTIONS (CONTINUED)

OPTIONAL MATERIAL FOR "WC SENSORS: (AVAILABLE MODELS 520-525)

XC001	Aluminum pressure connection, Viton® diaphragm, Viton® O-Ring
XC002	Aluminum pressure connection, Kapton® diaphragm, Buna-N O-Ring
XC003	Aluminum pressure connection, Kapton® diaphragm, Viton® O-Ring
XC004	316L stainless steel pressure connection, 316L stainless steel diaphragm, Viton® O-Ring (Over range pressure is limited to 100 psi)
XC005	316L stainless steel pressure connection, Viton® diaphragm, Viton® O-Ring
XC007	316L stainless steel pressure connection, Teflon® diaphragm, Viton® O-Ring

OPTIONS FOR TEMPERATURE MODELS

UNION CONNECTORS**

For all bulb & capillary switches, types E and F

Option	Replacement Number	Description
<u>Brass</u>		
W027	SD6213-27	1/2" NPT w/ 3/4" bushing
W045	SD6213-45	3/4" NPT
W051	SD6213-51	1/2" NPT
<u>304 Stainless Steel</u>		
W028	SD6213-28	1/2" NPT w/ 3/4" bushing
W046	SD6213-46	3/4" NPT
W050	SD6213-50	1/2" NPT

THERMOWELLS**

For all bulb & capillary switches, types E and F

<u>Brass</u>		
W075	SD6225-75	1/2" NPT with 3/4" NPT adapter bushing, 4" BT
W191	SD6225-191	1/2" NPT, 4" BT
W118	SD6225-118	1/2" NPT with 3/4" NPT adapter bushing, 7" BT
W192	SD6225-192	1/2" NPT, 7" BT
<u>316 Stainless Steel</u>		
W076	SD6225-76	3/4" NPT, 4.5" BT
W193	SD6225-193	1/2" NPT, 4.5" BT
W119	SD6225-119	3/4" NPT, 7.5" BT
W177	SD6225-177	1/2" NPT, 7.5" BT

For all immersion stem switches; types B and C

W139	SD6225-139	3/4" NPT X 1-23/32" BT, BRASS
W140	SD6225-140	3/4" NPT X 1-23/32" BT, 316 ST/ST

W000 IMMERSION STEM AND THERMOWELLS

Note: Option W000 is a special Immersion Stem construction that has no external thread. This option fits inside a special thermowell and is secured with a set-screw. Available on types B and C only.

Option	Description
W000	Immersion stem only, brass
W097	Immersion stem and thermowell. Includes W000 stem and 1/2" NPT x 1-23/32" BT brass thermowell
W099	Immersion stem and thermowell. Includes W000 stem and 1/2" NPT x 1-23/32" BT 316 st/st thermowell.

OPTIONAL LENGTHS:

Optional immersion stem lengths to 15" may be available in Brass, with or without 316 ST/ST thermowell. Consult UE for additional information and availability. Optional capillary length to *50' may be available in Copper or 304 ST/ST. Armor or Teflon® capillary protection may be available to lengths less than or equal to capillary length. Consult UE for additional information and availability.

* Consult UE regarding repeatability and ambient effects on capillary lengths over 30'.
 ** Dimensional drawings for union connectors and thermowells may be found at www.ueonline.com

DIMENSIONAL DRAWINGS

Dimensional drawings for all models may be found at www.ueonline.com

Internal Hex Screw Set Point Adjustment

Types J400, J402, J403, J400K, J402K, C400, C402, C403, F400, F402, F403

Set Point Adjustment via Reference Dial

Types H400, H402, H403, H400K, H402K, B400, B402, B403, E400, E402, E403

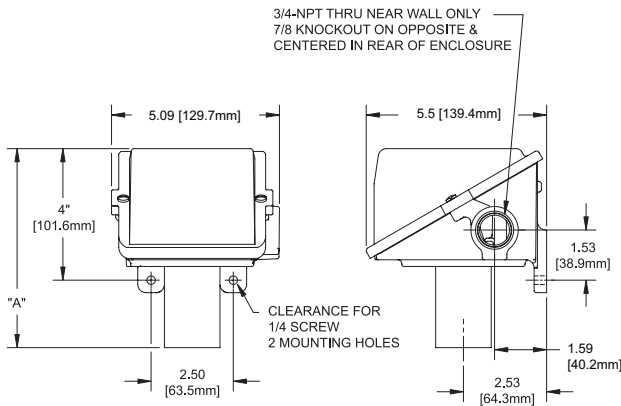

Models	Dimension A		
	Inches	mm	NPT
PRESSURE			
126-164	5.91	150.0	1/4
S126B-S164B	6.31	160.3	1/2
270-376	5.50	139.7	1/4
440-443, 449			
451, 453, 454	4.28	108.7	1/4
448, 450, 452	5.03	127.8	1/4
520-525	8.25	209.6	1/2
530-535	8.13	206.5	1/2
551, 553-555	4.56	115.8	1/4
550, 552	5.03	127.8	1/4
570-572	4.56	115.8	1/4
610-614	6.31	160.3	1/4
DIFFERENTIAL PRESSURE			
147-157	6.13	155.7	1/4
S147B-S157B	6.13	155.7	1/2
455-559	7.00	177.8	1/4
540-543	7.97	202.4	1/8
544-547	8.03	204.0	1/8
TEMPERATURE			
120, 121	7.38	187.3	Immersion Stem
1BS-8BS	6.72	170.7	Bulb & Capillary

Pressure Sensors *All dimensions stated in inches (millimeters)*

Models 126-164

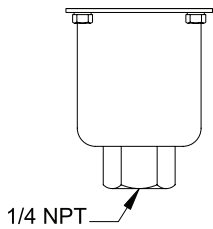

Models S126B-S164B

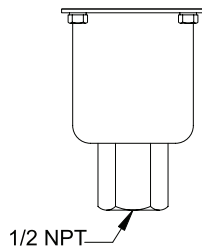

Models 270-376

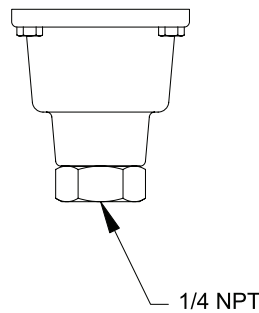

Models 440-454,
550-555, 570-572

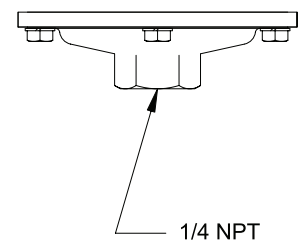

Models 610-614

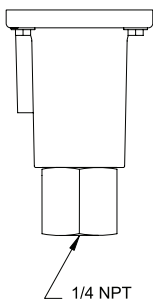

Models 520-525

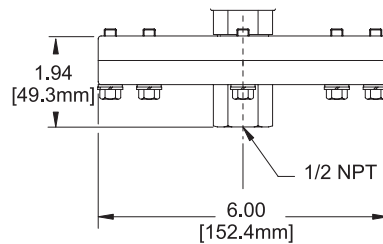

Models 530-535

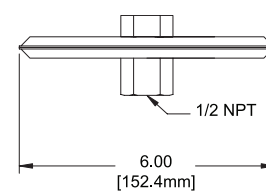

DIMENSIONAL DRAWINGS

Dimensional drawings for all models may be found at www.ueonline.com

Differential Pressure Sensors

Models 147-157

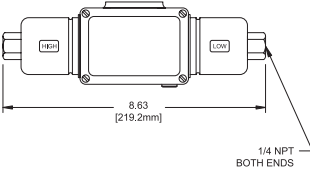

Models 540-543

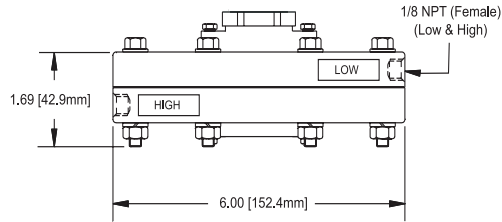

Models S147B-S157B

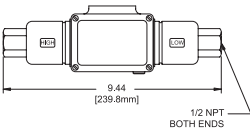

Models 544-547

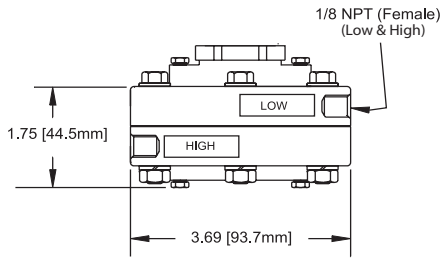

Models 455-457, 559

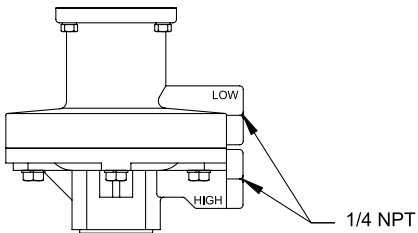

Temperature Sensors

Models 120-121

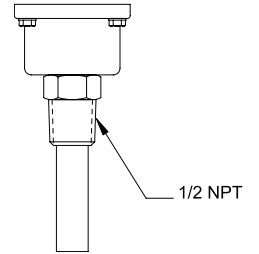

Local mount temperature version

Models 1BS-8BS

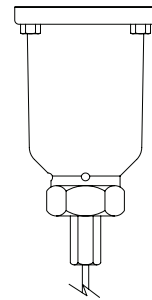

Remote mount temperature version

RECOMMENDED PRACTICES AND WARNINGS

United Electric Controls Company recommends careful consideration of the following factors when specifying and installing UE pressure and temperature units. Before installing a unit, the Installation and Maintenance instructions provided with unit must be read and understood.

- To avoid damaging unit, proof pressure and maximum temperature limits stated in literature and on nameplates must never be exceeded, even by surges in the system. Operation of the unit up to maximum pressure or temperature is acceptable on a limited basis (e.g., start-up, testing) but continuous operation must be restricted to the designated adjustable range. Excessive cycling at maximum pressure or temperature limits could reduce sensor life.
- A back-up unit is necessary for applications where damage to a primary unit could endanger life, limb or property. A high or low limit switch is necessary for applications where a dangerous runaway condition could result.
- The adjustable range must be selected so that incorrect, inadvertent or malicious setting at any range point cannot result in an unsafe system condition.
- Install unit where shock, vibration and ambient temperature fluctuations will not damage unit or affect operation. When applicable, orient unit so that moisture does not enter the enclosure via the electrical connection. When appropriate, this entry point should be sealed to prevent moisture entry.
- Unit must not be altered or modified after shipment. Consult UE if modification is necessary.
- Monitor operation to observe warning signs of possible damage to unit, such as drift in set point or faulty display. Check unit immediately.
- Preventative maintenance and periodic testing is necessary for critical applications where damage could endanger property or personnel.
- Electrical ratings stated in literature and on nameplate must not be exceeded. Overload on a switch can cause damage, even on the first cycle. Wire unit according to local and national electrical codes, using wire size recommended in installation sheet.
- Do not mount unit in ambient temp. exceeding published limits.

LIMITED WARRANTY

Seller warrants that the product hereby purchased is, upon delivery, free from defects in material and workmanship and that any such product which is found to be defective in such workmanship or material will be repaired or replaced by Seller (Ex-works, Factory, Watertown, Massachusetts. INCOTERMS); provided, however, that this warranty applies only to equipment found to be so defective within a period of 24 months from the date of manufacture by the Seller. Seller shall not be obligated under this warranty for alleged defects which examination discloses are due to tampering, misuse, neglect, improper storage, and in any case where products are disassembled by anyone other than authorized Seller's representatives. EXCEPT FOR THE LIMITED WARRANTY OF REPAIR AND REPLACEMENT STATED ABOVE, SELLER DISCLAIMS ALL WARRANTIES WHATSOEVER WITH RESPECT TO THE PRODUCT, INCLUDING ALL IMPLIED WARRANTIES OF MERCHANTABILITY OR FITNESS FOR ANY PARTICULAR PURPOSE.

LIMITATION OF SELLER'S LIABILITY

SELLER'S LIABILITY TO BUYER FOR ANY LOSS OR CLAIM, INCLUDING LIABILITY INCURRED IN CONNECTION WITH (I) BREACH OF ANY WARRANTY WHATSOEVER, EXPRESSED OR IMPLIED, (II) A BREACH OF CONTRACT, (III) A NEGLIGENT ACT OR ACTS (OR NEGLIGENT FAILURE TO ACT) COMMITTED BY SELLER, OR (IV) AN ACT FOR WHICH STRICT LIABILITY WILL BE INPUTTED TO SELLER, IS LIMITED TO THE "LIMITED WARRANTY" OF REPAIR AND/OR REPLACEMENT AS SO STATED IN OUR WARRANTY OF PRODUCT. IN NO EVENT SHALL THE SELLER BE LIABLE FOR ANY SPECIAL, INDIRECT, CONSEQUENTIAL OR OTHER DAMAGES OF A LIKE GENERAL NATURE, INCLUDING, WITHOUT LIMITATION, LOSS OF PROFITS OR PRODUCTION, OR LOSS OR EXPENSES OF ANY NATURE INCURRED BY THE BUYER OR ANY THIRD PARTY.

UE specifications subject to change without notice.

FOR A LIST OF OUR INTERNATIONAL AND DOMESTIC
REGIONAL SALES OFFICES PLEASE VISIT OUR
WEBPAGE WWW.UEONLINE.COM



UNITED ELECTRIC
CONTROLS

180 Dexter Avenue, P.O. Box 9143
Watertown, MA 02471-9143 USA
Telephone: 617 926-1000 Fax: 617 926-2568
<http://www.ueonline.com>

CP11111000