

Advanced technology
for measuring flow in
gases, liquids and
steam

SDF Flow Sensors



Contents

- Introduction..... 4
 - Functions 4
 - What makes up a complete flow measurement? 6
- Features..... 7
 - Consistently low pressure losses..... 7
 - Averaging even during disturbed velocity distribution 8
 - High accuracy 9
 - Large dynamic range 10
 - Long-term accuracy 10
 - Versatility..... 10
 - Suitable materials..... 11
 - Comparison and interchangeability with sensors according to ISO 5167..... 11
- The system 12
 - Selecting the appropriate type of sensor..... 12
 - Which sensor type for which pipe? 12
 - Design/layout of a SDF sensor..... 13
 - Design calculations 14
- Illustrations and tables 15
 - Equations for simplified design calculation..... 15
 - Typical constant pressure losses for SDF sensors 16
 - Maximum permissible differential pressures (in mbar)..... 16
 - Table of transfer coefficients of SDF sensors (k factors)..... 17
 - Inlet and outlet sections..... 18
 - Process with extremely short steadying zones 19
 - Using two sensors..... 19
 - Start-up calibration 19
 - Ordering codes for standard sensors with flange mounting (SDF-F) 21
 - Summary of the general specification data of SDF sensors 23
- FAQs 24

Introduction

Functions

A differential pressure flow measurement always consists of a minimum number of components that are absolutely essential:

- Sensor (pitot tube SDF-sensor, orifice plate according to ISO5167, etc.)
- Manifold (for calibration of the transmitter or shut-off against the process)
- Differential pressure transducer, also called differential pressure transmitter
- Flow computing unit to process the signal from the transmitter (often combined with an indicator, controller, etc.)

The following illustration shows in detail how this minimum configuration operates in practice:

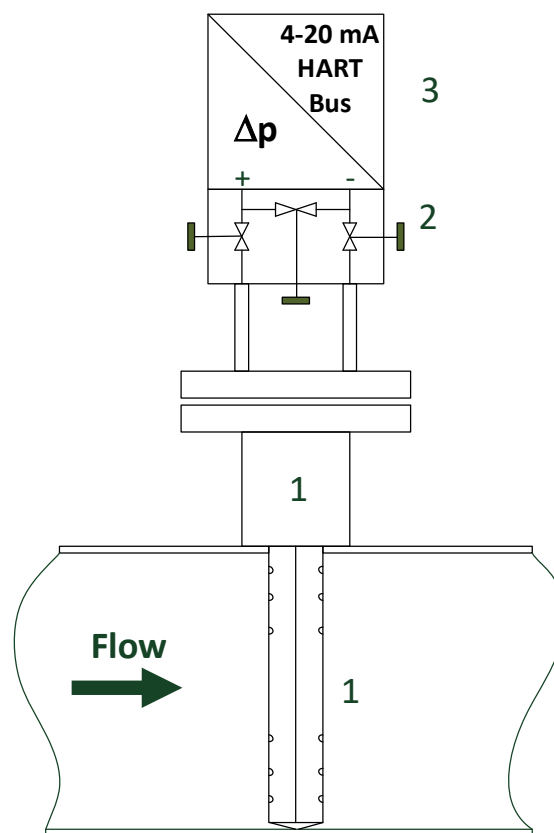

Minimum configuration of a measuring station:

1. SDF flow sensor
2. Calibration and Shut-off valves (3- or 5-way manifold)
3. Electronic differential pressure transmitter

The subsequent flow computing device is not shown in this diagram. Anything could be located here, from a simple digital display and a process control system. More on this topic later.

The purpose of the adjustment valve is in the zero point calibration of the differential pressure transmitter. This is essential, especially when measuring small quantities.

Operating Principle of a differential pressure flow measurement

The diagram to the right shows a pitot tube sensor inside a horizontal pipe. The sensor is mounted perpendicular to the direction of flow. The following explanation uses the pitot tube sensor as a sensor, but the principle is of course also valid for other differential pressure flow sensors (orifice plates, nozzles, etc.).

Flow direction is from left to right. The blue zone illustrates the velocity distribution inside the pipe.

At the location of the sensor the area of flow is constricted. Therefore the flow velocity around the sensor has to increase. This leads to a local overpressure zone in front of the sensor, shown by the red zone.

In accordance, a low pressure zone forms at the backside of the sensor (technically the backside can be referred to as the suction side).

The (pressure) difference between these two sides is passed via the sensor to the aforementioned differential pressure transmitters.

Its task is to convert the differential pressure into an electrical signal that can be further processed by the electronic equipment (flow computer, distributed control system, etc.).

For a medium with density ρ the relationship between differential pressure Δp and the flow velocity v can be described as:

$$v = k * \sqrt{\frac{2 * \Delta p}{\rho}}$$

More on that in subsequent sections.

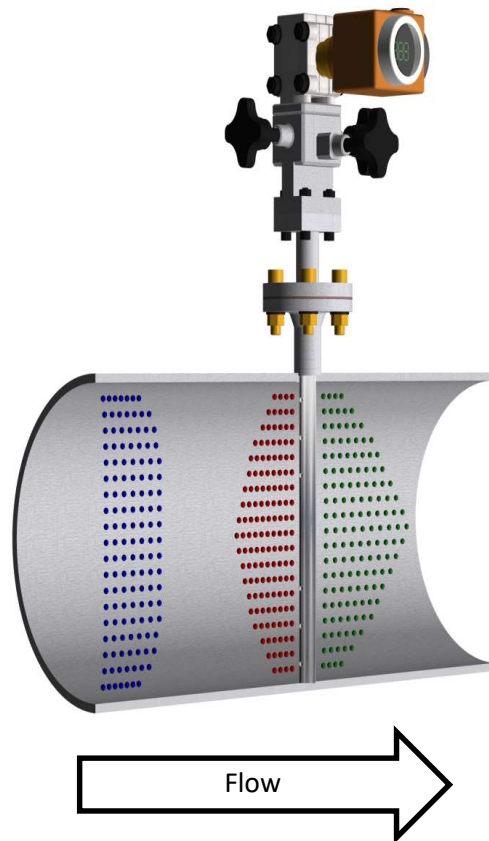

What makes up a complete flow measurement?

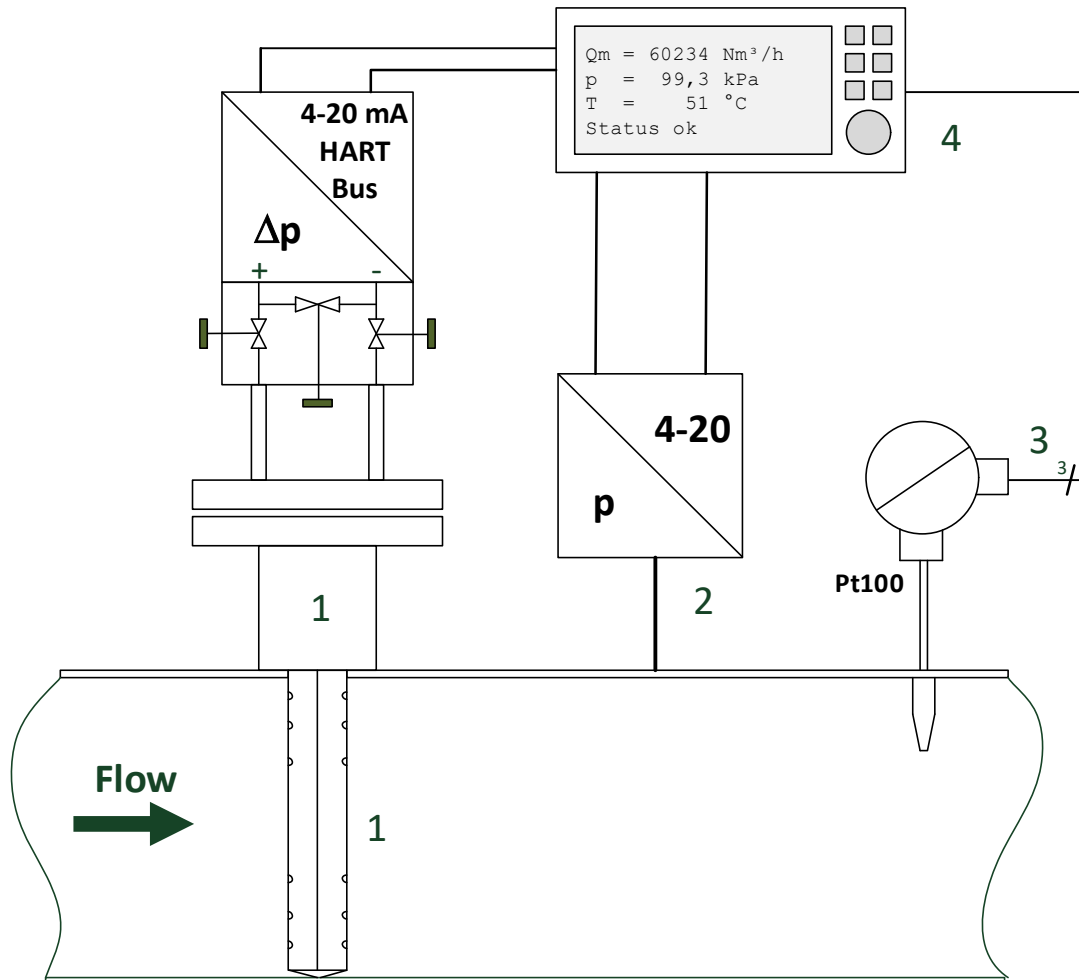

Fully configured differential pressure flow measurement section (example):

- 1. Differential pressure sensor (SDF-sensor, 3-way manifold, differential pressure transmitter)**
- 2. Absolute pressure transmitter**
- 3. Pt100 temperature sensor (built into the protective case)**
- 4. Flow computer for pressure and temperature compensation**

If pressure and temperature change during operation the density will change. If the change of density is not compensated it will lead to inaccuracy of the flow measurement result. By the means of a temperature sensor (e.g. Pt100 sensor), an absolute pressure sensor and a flow computer the actual density can be calculated.

The flow computer also usually compensates other quantities such as thermal pipe expansion.

Features

Consistently low pressure losses

In piping systems pressure losses are, more often than not, undesirable side effects. Minimising these is one of the main requirements in the search for appropriate instruments. Therefore, devices and sensors with no obstruction of the pipe cross section are particularly useful. These include ultrasound measuring devices or magnetic-inductive flow meters. Both methods have limitations, however, which often exclude their use. SDF sensors are very often installed where differential pressure transmitters can also be used according to standards such as ISO 5167, AGA 3 or to specific manufacturer standards.

Pressure loss is energy loss and usually means undesirable increase of operational costs. For steam, the pressure loss results in a reduction of working capacity (e.g. less pressure can be used in a steam turbine to generate electricity). With other media, such as natural gas or combustion air, pressure loss means more power is required to generate sufficient pressure to transport the media from point A to B.

The following table compares a typical steam flow measurement with orifice against an SDF sensor. The example shows that the pressure losses result in a considerable loss of energy and therefore also a lot of money.

	Orifice	SDF sensor	Unit
Max. differential pressure (1)	200	23.55	mbar
Constant pressure loss	63	12	% of (1)
Flow	11562		kg/h
Condition before the sensor			
Absolute pressure	400.0		kPa
Temperature	150.0		°C
Condition after the sensor			
Absolute pressure	387.4	399.7	kPa
Temperature	149.99	149.99	°C
Energy loss per hour	19.35	0.43	kWh

Averaging even during disturbed velocity distribution

In this section we show you the particular suitability of the SDF sensors in reducing the need for flow steadying zones in comparison with other methods of measurement by

- geometric averaging of the velocity over the cross section
- the special relationship between the size of the openings with the interior volume of the measuring sensor
- the completely symmetrical arrangement of the measuring holes on the front and the back.

One of the “secrets” of the SDF sensors is the arrangement of the measuring holes. The distribution over the sensor profile results in a geometric averaging measurement of the pressure, both at the high pressure upstream side and at the low pressure suction side.

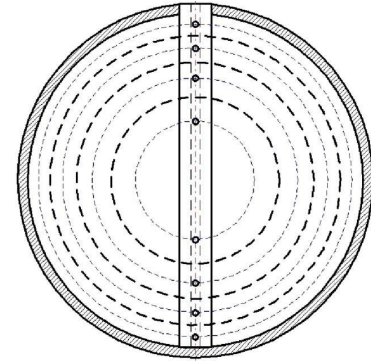

The advantage of the measurement principle can be shown by comparison of SDF-sensors to a single path ultrasonic flow meter. The ultrasonic signal runs for a specified time through the internal diameter – the runtime of the ultrasound is a measure for the arithmetic mean of the flow velocity in the flow lines. The unequal distribution of velocity inside the pipe cannot be measured and leads to inevitable systematic errors.

Another advantage of the design of SDF sensors is the ratio of internal volume of the sensor (inside the chambers) compared to the area of the measuring holes. An analogy to electrical engineering explains why: the **characteristic ratio of the size of the port openings to the volume of the sensor** behaves hydraulically similarly to the way an electrical RC circuit behaves in electrical terms. A large volume buffers compensation flows, a large (flow) resistance reduces balancing processes using externally applied signal differences. In other words: different velocity distributions in a pipe lead to different dynamic conditions in the area of the measured orifices. These differences can lead to transient currents, which could in some cases even cause reverse flows from the sensor to filter out into the process. This eliminates or at least reduces the specific design of the SDF sensor with massive internal volume at comparatively minimal size of the measuring orifices. The same goes for pitot measurement sensors with slots on the upstream side – easy to produce, but metrologically wrong!

The last point is the design of the measurement holes at the backside of the sensor. One could argue why it is not enough to simply measure the static pressure as “low pressure” signal. But due to the design of the sensor the pressure at the backside of the sensor is significantly lower than the static pressure (it can be compared to the upper side of an airplane wing). Therefore it is crucial to measure the low pressure at the suction side in the same way of the high pressure at the upstream side.

High accuracy

This section shall give an insight into the results of hundreds of experiments on test rigs where SDF sensors were tested for the deviation of our stated flow rates from the real measured values.

SDF sensors provide, in comparison with the standard measuring orifices and nozzles in accordance with ISO 5167, a highly linear output signal. This means that regardless of the flow velocity and the media properties, the transfer characteristic of an SDF sensor remains stable under all specified conditions. This is not the case for most orifices and nozzles according to ISO 5167. The problems are shown in the following table: if an orifice measurement deviates from its design point, the system-related measurement errors increase considerably. The same problem arises with nozzles. Among the sensors according to ISO 5167 only the traditional Venturi tube is mostly unaffected from a change in Reynolds number (measure for flow velocity), comparable to an SDF sensor.

The non-linearity of an orifice plate is shown with a sample application of a steam flow measurement (parameters: diameter = 250 mm, design pressure = 4bar abs., temperature = 150°C, orifice opening diameter $d = 120$ mm and opening ratio $\beta = 0.48$). The following table is calculated based on the information available in ISO 5167 for the deviation of the transfer coefficient C from the design point:

Differential pressure [mbar]	Indicated Flow [kg/h]	Actual Flow [kg/h]	Error rate
12.5	2,891	2,975	2.85%
25	4,088	4,201	2.69%
50	5,781	5,919	2.33%
100	8,176	8,307	1.58%
200	11,562	11,562	0.00%
400	16,352	15,818	-3.38%

The errors quoted here do not include the base measurement uncertainty. These errors must be counted in addition to the aforementioned linearity errors.

In comparison, here are the uncorrected measurement errors of an SDF sensor in a test run with a national calibration laboratory:

Ergebnis der Kalibrierung
Calibration result

Ausg. mA Soll mA	Ausg. mA Ist mA	Dichte kg/m ³	Soll-Volumen l	Messzeit s	Impulse [mA]	Soll-Masse kg	Belastung t/h	Messabw. %
4,3946	4,3916	999,70	805,74	379,25	83276	805,498	7,65	-0,77
4,7659	4,7715	999,70	756,01	183,35	43743	755,783	14,84	0,73
5,5979	5,6053	999,70	817,22	95,00	26625	816,975	30,96	0,46
8,6691	8,6346	999,70	8679,00	345,28	149067	8676,396	90,46	-0,74
11,8055	11,7827	999,70	8819,00	209,87	123642	8816,354	151,23	-0,29
15,3691	15,3442	999,70	8493,00	138,76	106458	8490,452	220,28	-0,22
18,4921	18,5254	999,70	8508,00	109,05	101010	8505,448	280,79	0,23

Large dynamic range

The above shown calibration protocol illustrates the large dynamic range of a differential pressure flow measurement with SDF sensor.

To put this into comparison let us consider vortex meter as used in many applications. It has the reputation of having an extremely wide measuring range. To put this into perspective we will use the water flow measurement setting used in the calibration shown above (pipe diameter = 159 mm, $t = 20\text{ °C}$, mass flow = 310 t/h).

According to well-known manufacturer of Vortex meter the accuracy at Reynold's numbers below 20.000 for water measurement is 0.85% full scale. A flow rate of 7.65 t/h (lowest point of flow in above table) results in a Reynold's Number of 9,473. Therefore the error of the Vortex meter at this point is +/- 2.64 t/h (=0.85% of 310 t/h design flow) or **34.4% error** of the actual flow. The SDF sensor at the same point of operation shows an actual error of 0.77%. The resulting dynamic range of the SDF sensor is considerably larger.

Long-term accuracy

For proper function the measuring orifice plates require very sharp internal edges (to ensure reproducible flow detachment). During regular operation these edges are subject to permanent stress since the flow velocity at the orifice is significantly increase. The situation becomes worse if particles (e.g. dust) are present.

When the edges of an orifice plate are worn down the orifice cannot work according to the standards anymore and the accuracy becomes considerably worse.

In comparison: If on a type 22 SDF sensor an unrealistic 10% will be removed from the outer section due to abrasion, an additional deviation of 0.49% on the measurement value will be produced. In other words – normal wear and tear shows no detectable effect on the measurement result.

Versatility

SDF sensors can be used universally. Basically, they can be used anywhere where other differential pressure transmitters would also be considered suitable. This applies not only to orifice plates, nozzles and traditional venturi pipes according to ISO 5167 and AGA-3, but "V Cones" and other exotic devices, to which special properties are attributed.

Specifically, the fields of application include

- technical and natural gases, even those with high water content (such as biogas and landfill gas), contaminated by dust or corrosive elements
- liquids (such as boiler feed water, condensate and thermal oil)
- steam, even at very high pressures and temperatures.

SDF sensors are not suitable for pastes, sludges and adhesive media. In conductive water SDF sensors are suitable, especially for small diameters but magnetic inductive measuring devices are, in economic and technical measurement terms, the device of choice.

Suitable materials

Material	Use/application
1.4404	Standard materials of SDF sensors (optional: materials for weld-on mounting parts)
2.4816 (Inconel 600)	High temperature materials for temperatures of up to 900°C
2.4633 (Inconel 602)	High temperature materials for temperatures of up to 1150°C with high resistance to corrosion, but unsuitable for air over 1000°C
1.4539	Corrosion resistant austenitic steel – use for wetted parts in SDF sensors
P235GH	Material for welded attachments for mounting an SDF sensor in the pipe. Continuous operation up to 400°C
1.5415 (15/16 Mo 3)	Temperature-resistant steel boiler (suitable up to 530°C wall temperature)
1.7335 (13CrMo4-5)	Alloy steel stable at high temperatures (suitable up to 560°C wall temperature) – the use of SDF-weld-on components in high-temperature steam measurements
1.7380 (10CrMo9-10)	Alloy steel stable at high temperatures (suitable up to 590°C wall temperature) – use for SDF weld-on components in high-temperature steam measurements
1.4923 (X22CrMoV 12-1)	Extremely high temperature resistant stainless steel for live steam applications with operating temperatures over 600°C
1.4841 (X15CrNiSi 25 20)	Heat-resistant stainless steel suitable for temperatures in a range from 900 to 1120°C, including air

Comparison and interchangeability with sensors according to ISO 5167

Criterion	Orifices	Nozzles	Traditional Venturi	SDF sensors	AccuFlo® HMP
Pressure loss	High	High	Low	Low	Low
Accuracy	Limited	Limited	High	High	Very high
Long-term stability	Low	Given	Very high	Very high	Very high
Price	Low	High	Very high	Low-medium	High
Installation	Complex	Complex	Complex	Easy-medium	Medium Plug'n Play
Turn Down	Limited	Limited	High	High	Very high
Part of ISO 5167?	Yes	Yes	Yes	No	No
Calibration	Complex	Complex	Complex	Possible	Standard

The system

Selecting the appropriate type of sensor

In this section we will show you how to select a suitable SDF-type sensor based on the essential features of your application. In most cases, this specification can be performed very quickly and easily. If you are still unsure, please contact our specialists who are always happy to advise you.

Which sensor type for which pipe?

The sensor type depends primarily on the inner diameter of the pipeline, but the mechanical loading of the sensor by the flow and the resulting mechanical stresses must also be taken into account. The chart below shows the diameter ranges for the use of individual sizes:

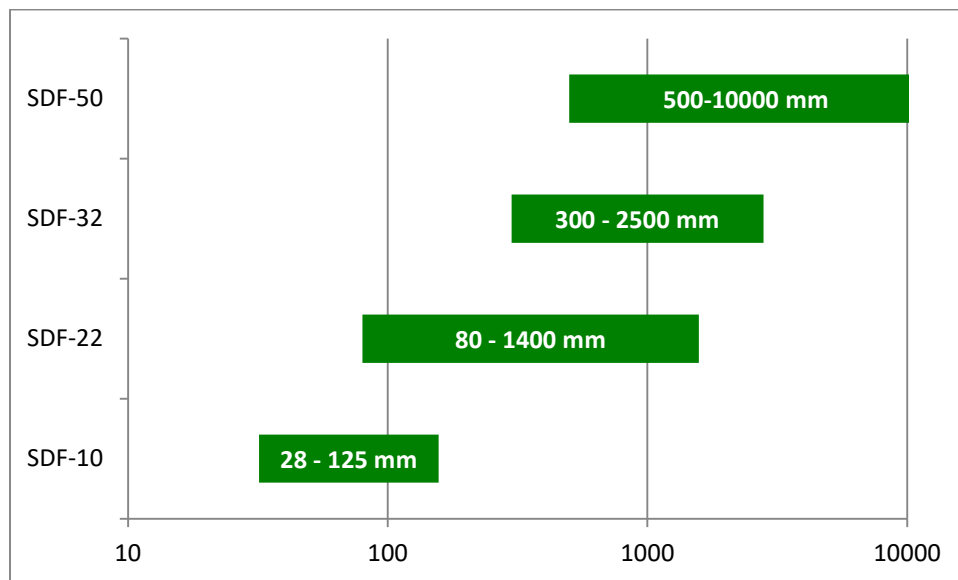

Attached you will find the table "Maximum permissible differential pressure (in mbar)" (page 3), with whose help the smallest yet most appropriate SDF flow sensor for a specific application can be determined.

Design/layout of a SDF sensor

In this section we will show you an example of the composition of an order reference code for the SDF sensors, allowing you to even specify the correct sensor in most cases.

Typically the order reference code of an SDF sensor reflects the sensor completely. Conversely, you can therefore find out what constitutes a sensor, just by studying the order reference code. Therefore, the best way to explain the composition of an SDF sensor is to use a concrete example of an order reference code:

SDF-F-107.1 mm-3.6 mm/50 mm-S-C-0-PN40-FPK-DE3-T1-V

Such a sensor is a typical sensor for flow measurement of gases and liquids. The type code can be deciphered with the table below.

1	SDF	Product ID
2	F	Basic design: here "F" stands for a sensor which is mounted by means of a flange on a counter flange welded to the pipeline.
3	107.1mm	The inner diameter of the pipeline
4	3.6mm/+50mm	The figure on the left represents the wall strength of the pipeline; the figure on the right represents the neck extension of the sensor to accommodate thermal insulation . If there is no insulation, this figure is absent.
5	S	This letter represents the material of the sensor itself. "S" stands for standard material 1.4404.
6	C	The pipeline material: here "C" stands for the "material group 2", i.e. the simple carbon steels (e.g. P235 GH). The "E" stands for weld-on components made of stainless steel Mat.Nr. 1.4404 (material group 1). We manufacture the weld-on components from the raw material.
7	0	End support: "0" stands for "no end support"
8	PN40	Pressure stages in plain text
9	FPK	Connecting the primary barrier. "FPK" refers to our standard solution, the so called flange plate. It is a steel plate located at the sensor head where the 3-way-manifold can be mounted. Since all components (sensor, manifold, transmitter) are mounted together this is usually called the "compact measurement".
10	DE3	Type of primary isolation chosen: "DE3" stands for a stainless steel three-way manifold block with double-sided 7/16"-UNF cadmium-plated carbon steel screws.
11	T1	Accessories: here "T1" stands for an integrated Pt100 resistance thermometer in 3-wire version with replaceable measuring sensor without electric transmitter in the connection head.
12	V	Pipeline route: "V" = vertical, "H" = horizontal

Using this system, the code

"SDF-DF-10-54.5mm-2.9mm-S-C-0-PN40-KT-FWNC-0-H"

describes a standard steam sensor with flange connection on a carbon steel pipeline (DN50, PN40, horizontal) including compact mounting of the differential pressure transmitter on a 5-way manifold (directly mounted to the sensor head together with condensation trap). This version is readily available for temperatures up to 300°C – also with custom valves for higher temperatures.

Design calculations

When pre-calculating an SDF sensor essentially two points need to be clarified:

1. How much differential pressure must the SDF sensor bear, depending on the specific application data?
2. Is the chosen sensor adequate for this differential pressure? Is the differential pressure high enough for the electrical differential pressure transmitter?

Designing the SDF-Sensor is very easy and with the help of our online sizing tool. This software can be found at <http://www.ski-gmbh.com/swa>. To use the programme you need to register by entering your email address and name. Once you create your own password, you can do your own calculations, save them and access them again, as long as you are connected to the internet.

You can also calculate the differential pressure with the help of the equations in the table “Equations for simple design calculations” on page 15. For rough calculations, it is sufficient to take the k-factor of the chosen SDF-sensor from the table ‘Table of transfer coefficients of SDF sensors (k factors)’ on page 17.

Due to the complexity and the various checks that have to be done we recommend to size the element with above linked software or consult us directly.

Illustrations and tables

Equations for simplified design calculation

Simplified differential pressure equations	
Basic equation	$v = k * \sqrt{\frac{2 * \Delta p}{\rho}} \text{ mit } [\Delta p] = Pa \text{ (1)}$
Speed	$\Delta p = \frac{\rho}{2} * \left(\frac{v}{k}\right)^2 \text{ mit } [\Delta p] = Pa \text{ (2)}$
Volume flow	$\Delta p = \rho * \left(\frac{25 * \dot{V}}{k * ID^2}\right)^2 \text{ (3)}$
Mass flow	$\Delta p = \frac{1}{\rho} * \left(\frac{25 * \dot{m}}{k * ID^2}\right)^2 \text{ (4)}$
Special case of standard volume flow for gases	$\Delta p = \frac{\rho_N * T_B}{p_B} * \left(\frac{15,23 * \dot{V}_N}{k * ID^2}\right)^2 \text{ (5)}$
Unit	
Speed	$[v] = m/s$
Volume flow, standard volume flow	$[V] = m^3/h, [V_N] = Nm^3/h$
Mass flow	$[\dot{m}] = kg/h, [qm]=kg/s$
Pressure	$[p] = kPa \text{ abs.}$
Temperature	$[T] = K$
Differential pressure	$[\Delta p] = mbar$
Inner diameter	$[ID] = mm$
Ratios for SDF sensors in ISO 5167 notation	
Orifice ratio	$\beta = \sqrt{1 - \frac{4*br}{\pi*D}}$ br is the projected width of the SDF probe in the flow direction)
Flow coefficient	$C = k * \sqrt{\frac{1 - \beta^4}{\beta^4}}$
Differential pressure formula for mass flow	$dp = \frac{1}{\rho} * \left[0,9003 * \frac{qm}{k * \epsilon * D^2}\right]^2$

Typical constant pressure losses for SDF sensors

SDF type		10	22	32	50
Inner diameter in mm	Pressure loss in % of the differential pressure				
	50	29	-	-	-
	100	15	29	-	-
	150	-	19	-	-
	200	-	15	19	-
	250	-	12	16	-
	300	-	10	13	21
	400	-	7	10	15
	500	-	6	8	12
	600	-	5	6	10
	700	-	4	6	9
	800	-	4	5	8
	900	-	3	4	7
	1000	-	3	4	6

For example, a SDF-22 sensor for a diameter DN300, for which a maximum differential pressure of, for example 28.63 mbar was calculated, will produce a constant pressure loss of approximately 10% at this work point, equal to 2.8 mbar.

Maximum permissible differential pressures (in mbar)

Type	SDF-10		SDF-M-22		SDF-F-22		SDF-32		SDF-50	
	without	with	without	with	without	with	without	with	without	with
	end support									
40	2265	36251								
50	1417	22672								
65	852	13626								
80	618	9894								
100	367	5870								
125	243	3882	6608		971					
150			4517		663					
200			2667		391					
250			1690		248					
300			1195	2808	176	2808	312			
350			983	2311	144	2311	257			
400			752	1767	111	1767	196	3142		
500			470	1105	69	1105	123	1964		
600			323	759	47	759	84	1349	213	3400
700			237	558		558	62	991	156	2499
800			181	424		424	47	754	119	1900
1000			116	272		272	30	483	76	1217
1250				188		188		334	53	842
1500				138		138		245	39	618

Table of transfer coefficients of SDF sensors (k factors)

ID	SDF-10	SDF-22	SDF-32	SDF-50
50	0.5495			
65	0.6090			
80	0.6332			
100	0.6477	0.5495		
125	0.6559	0.6026		
150		0.6271		
200		0.6477		
250		0.6559	0.6443	
300		0.6600	0.6526	
350		0.6623	0.6572	
400		0.6637	0.6600	0.6447
450		0.6647	0.6618	0.6504
500		0.6654	0.6631	0.6542
600		0.6662	0.6647	0.6589
700		0.6667	0.6656	0.6615
800		0.6670	0.6662	0.6632
900		0.6672	0.6666	0.6643
1000		0.6674	0.6669	0.6650
1100		0.6675	0.6671	0.6656
1200		0.6676	0.6672	0.6660
1300		0.6676	0.6673	0.6663
1400		0.6677	0.6674	0.6665
1500		0.6677	0.6675	0.6667
1600			0.6676	0.6669
1700			0.6676	0.6670
1800			0.6677	0.6671
1900			0.6677	0.6672
2000			0.6677	0.6673
2500				0.6676
3000				0.6677

Inlet and outlet sections

In general, for the proper function of SDF sensors, the following Steadying zones must be kept in front of and behind of a deviation from the straight uninterrupted pipe route.

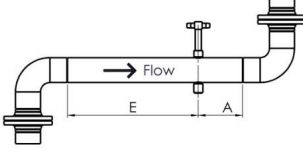
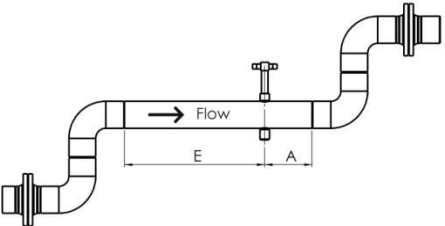
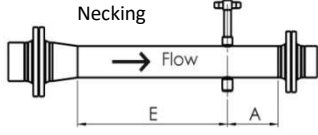
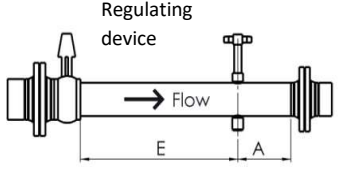
Pipe route	Inlet	Outlet
	7*ID	3*ID
	10*ID	3*ID
	7*ID	3*ID
	20*ID	5*ID

Important note: please consult us if you are dealing with shorter Steadying zones than the ones shown here.

Process with extremely short steadying zones

Using two sensors

Often times a flow measurement shall be installed without sufficient inlet or outlet steadying zones, especially in larger pipelines. Therefore, we have carried out many experiments in this area and can demonstrate conclusive results. Clear operational rules can be derived from these experiments. We attempted to solve the problem of finding a reproducible solution even under difficult conditions when using a short Steadying zone. We compared the results of an SDF sensor in the same flow but at three different installation points:

1. the optimal placement with a x10 inner diameter (ID) as a Steadying zone in front of the measuring point and x5 ID as a Steadying zone behind;
2. the placement with a x5 ID inlet section and without an outlet section (x0 ID)
3. the placement without an inlet section (x) ID) and with a x5 ID outlet section

The following table shows a selection of the results we obtained:

	Attempt 1	Attempt 2	Attempt 3
Steadying zones	* ID		
Inlet	10	5	0
Outlet	5	0	5
Mass flow in t/h	Deviation in %		
20	0.36	-0.60	1.43
50	0.20	-1.17	0.92
140	-0.39	-1.26	0.70
270	-0.77	-1.51	0.50

The conclusion of this experiment is: using two crosswise SDF flow sensors, in the absence of an inlet section, produces a measurement value with an accuracy of +/-2% in the flow ratio of minimum to maximum flow rate in the range of 1:13!

Start-up calibration

While deviating significantly from the DIN 1946-recommended inlet and outlet sections, an on-site calibration is the most reliable method to determine the actual flow rate in gas channels. In other media, checking with an anemometer, pitot tube or the like is not advisable, due to the temperature and pressure conditions and the associated health risks.

The procedure uses the following basic formula for the differential pressure sensors:

$$v = k * \sqrt{\frac{2 * \Delta p}{\rho}}$$

Here, the k-factor characterises the interaction of the sensor, pipe (whose component the sensor has become after being mounted) and the streaming media. Since all other factors are pure physics, only the k-factor closely reflect this interaction. The factory-made k-factor corresponds to the ideal values determined by our bench tests.

The real k-value is the lever for a correction of the deviation between test and measurement of the specific arrangement. If you have a choice, we recommend the correction of the k-factor using a pitot or Prandtl pipe or similar procedures. These measuring sensors are not designed or recommended for stationary industrial applications due to their low differential pressures and other aspects. For the calibration of SDF sensors, however, they are well suited, because the influences of the media in both density measurement methods cancel each other out. This simplifies the procedure considerably.

To perform a calibration measurement, we must do two things:

1. We must have as many views of the flow as possible, i.e. the more measurement points taken, the better. It is best when at least two axes are measured.
2. We need to weight the results in a way that each point is given its due importance. This can be done by calculation or by selecting the measuring point.

In practice, it is easier to fix the measurement points in advance, so that the weighting then happens of its own accord. Of course it makes sense to keep the operating conditions almost constant during the measurement process. Considerable fluctuations of more than 10% of flow rate lead to individual measurements which cannot be compared with each other.

Ordering codes for standard sensors with flange mounting (SDF-F)

SDF										
										Pipe mounting Basic price (up to max. PN64, SDF-32 max. PN40, SDF-50 max. PN16) Basic price (PN100) 1.4404 only Basic price (PN160) 1.4404 only Special model
	F									
	F									
	F									
	FX									
										Profile type Inner diameter: 28 - 125 mm Inner diameter: 80 - 1400 mm Inner diameter: 300 - 2500 mm Inner diameter: 500 - 10000 mm
		10								
		22								
		32								
		50								
										Inner diameter (number values with unit) Price per 100 mm
										Wall strength/+ neck extension (number values with unit) Price per 100 mm (up to max. PN64) Price per 100 mm (PN100/160)
										Special materials for media-touched components (factors) Mat.Nr. 1.4404 (316L) Mat.Nr. 1.4541 (only with process connection "R", "N2" o. "X") Mat.Nr. 1.4539 (only with process connection "R" o. "X") Hastelloy C22 (only with process connection "R" o. "X") Inconel 602 (only with process connection "R" o. "X") Special materials
					S					
					41					
					R					
					H					
					HT					
					X					
										Mounting components materials (without end support) PN16/40: Typ10=DN15; Typ22=DN32; Typ32=DN40; Typ50=DN80 PN64/100/160: Typ10=DN25; Typ22=DN40; Typ32=DN40; Typ50=DN80 Flange, carbon steel, PN16 Flange, carbon steel, PN40 Flange, carbon steel, PN64/100 Flange, 1.4404, PN16 Flange, 1.4404, PN40 Flange, 1.4404, PN64/100 Special model
						C				
						C				
						C				
						E				
						E				
						E				
						X				
										End support Without End support with carbon steel R1"plug (max. PN40 180°C) End support (pipe thread & cap) carbon steel (max. PN40 180°C) End support (pipe thread & cap) 1.4404 (max. PN40 180°C) End support with flange, carbon steel, PN16 End support with flange, carbon steel, PN40 End support with flange, carbon steel, PN64/100 End support with flange, 1.4404, PN16 End support with flange, 1.4404, PN40 End support with flange, 1.4404, PN64/100 Closed end support, carbon steel, max. PN100 Closed end support, 1.4404, max. PN100 Special model
							O			
							SC			
							SC			
							SE			
							GF			
							GF			
							GF			
							GF			
							GF			
							GF			
							GG			
							GG			
							X			

SDF										
										Pressure stages (e.g. "PN16", "CL300." or similar)
										Process/differential pressure connections
								N2		Nipple with 1/2-14-NPT external thread
								N4		Nipple with 1/4-18-NPT external thread
								R2		Nipple with R1/2" external thread
								R4		Nipple with R1/4" external thread
								R		Spouts 12mm
								S		Hose stem 10.5 x 1.5mm
								FP		Flange plate for assembly of a 3-way valve block (only without integrated temperature recording)
								FPD		Double-flange for the construction of two 3-way valve blocks (only without integrated temperature recording)
								FPK		Flange plate for constructing a 3-way valve block but rotated by 90°, for integrated temperature recording for example
								FPX		Special direct mounting device, for reversing tap mounting
								X		Special model
										Initial barrier
								0		no initial barrier
								KE		Ball valves PN40 of 1.4401 (max. 200°C)
								AC1		Stop valves PN420 DN5, carbon steel, 1/2" NPT (max. 200°C)
								AE1		Stop valves PN420 DN5, 1.4404, 1/2" NPT (max. 200°C)
								DE1		3-way valve block, materials 1.4401 (max. 200°C) Screws: process-relevant 7/16-UNF cadmium-plated, differential pressure transmitter-relevant, metric, stainless steel (only with flange plate)
								DE2		like 'DE1', but with process-relevant screws 7/16-UNF stainless steel
								DE3		like 'DE1', but with differential pressure transmitter-relevant screws 7/16-UNF cadmium-plated
								DE4		like 'DE2', , but with differential pressure transmitter-relevant screws 7/16-UNF stainless steel
								FE1		5-way valve block, material 1.4401 (max. 200°C), Screws: process-relevant 7/16-UNF cadmium-plated, differential pressure transmitter-relevant, metric, stainless steel (only with flange plate)
								X		Special model, see extra brochure if required
										Accessories (multiple selection possible; separate with "/")
								0		without
								VC		1 pair of fittings for 12 mm pipe connection, carbon steel
								VE		1 pair of fittings for 12 mm pipe connection, 1.4571
								UE		Multiway position tap PN100 with purging connection made of 1.4571 (max. 200°C)
								CH		One-sided cleaning ports for compressed air supply (R1/8")
								IH		Inspection and cleaning ports (only advisable with end support)
								X		Special model, see extra brochure if necessary
										Pipe route
								H		Horizontal
								V		Vertical (also on a slanting route)

Summary of the general specification data of SDF sensors

- Suitable for the measurement of gases, fluids and steam
 - Two-chamber profile, symmetrical construction
 - Two-way operation is possible
 - Inherent vortex Steadying (“Karmann’sche Wirbelstraße” theory)
 - Dynamic measuring range: depends on the lowest differential pressure; recommendation:
 - Gases: smallest possible full scale differential pressure $\Delta p_{FS,min} = 1 \text{ mbar}$
 - Steam/liquids: smallest possible full scale differential pressure $\Delta p_{FS,min} = 5\text{-}10 \text{ mbar}$
 - Pipe diameter from DN40 to DN11000
 - Materials
 - Wetted parts: 1.4404 (standard); optional: Hastelloy C22, Inconel 602, Monel, 1.4871, 15 Mo 3, 1.4922/P91/P92 – other materials available on request
 - Mounting components: P235GH (standard); optional: 1.4404, 15/16 Mo 3, 1.7380, 1.4922 – other materials available on request
 - Temperature of the medium to be measured: -180°C to 1100°C
 - Pressure stages: PN16 (standard) to PN420 (3000 lbs.); special pressures available on request
 - Conformity to DGRL 2014/68/EU
 - Max. measurement deviation: typically 1% of the measurement value in the specified dynamic range
 - Dynamic:
 - Max. 1:10 with a measuring transmitter
 - Max. 1:40 in split range operating mode (max. deviation in the range 1:10 less than 1% of the measurement value)
 - Connections:
 - $\frac{1}{2}$ “-14-NPT-m (standard for gases and liquids)
 - Flange connection for direct mounting of a differential pressure transmitter (optional)
 - Condensation vessel with welded connection (standard for steam)
 - Compact head with integrated condensation vessels (optional for steam)
 - Mounting in the pipeline: materials depending on pipeline material, construction:
 - Weld-on connection piece with cutting ring fitting
 - Mounting flange depending on pressure stage
 - Contamination of the measurement materials:
 - Dry dust: max. 100 mg/m^3
 - Max. 10 g/m^3 dust when using an air purging system LSE-HD (consult manufacturer for higher dust load)
 - Acidic components in the material to be measured: adapt the material to the wetted parts
 - Particular qualities/features:
 - High accuracy and excellent dynamics
 - Consistently low pressure losses
 - Low procurement and installation costs
 - Easy to retrofit
 - Two-way operational mode
 - Robustness and insensitivity to contamination of the material to be measured
-

FAQs

The flow computer unit can only calculate the flow rate in relation to a deviation from the design point. How should the transfer equation look under these circumstances?

The amount of the mass flow to be determined depends, for compressible media, not only on the measured differential pressure, but also on pressure and temperature which affect the density of the medium. During the design of the flow measurement you determine the differential pressure around a specific pressure-temperature-value pair. If the signal now deviates in practice from this values a correction must be made. This correction is relatively complicated and generally should be left to a special process computer. Only for measurements with idealised gases (i.e. all gas measurements with pressures that are not too high), the correction can be made using the following formulas:

$$qV_N = \sqrt{\frac{p * T_D * \Delta p}{p_D * T * \Delta p_D}} * qV_{N,D} = \sqrt{\frac{p * T_D}{p_D * T}} * qV_{N,D} * \sqrt{\frac{i_{\Delta p} - 4mA}{16 mA}}$$

If the differential pressure transmitter square roots already, then this results:

$$qV_N = \sqrt{\frac{p * T_D}{p_D * T}} * qV_{N,D} * \frac{i_{\Delta p} - 4mA}{16 mA}$$

The index "D" stands here for design data ("design"), the values without index "D" stand for currently measured operating values. $i_{\Delta p}$ is the flow measured by the differential pressure transmitter.

How does the transfer curve of the output signal appear as a function of the mass flow?

The curve is derived from the "mother of all differential pressure equations", which was given at the beginning of this document.

$$v = k * \sqrt{\frac{2 * \Delta p}{\rho}}$$

When applied to the context of the current output of a differential pressure transmitter for flow rate, a characteristic curve is produced.

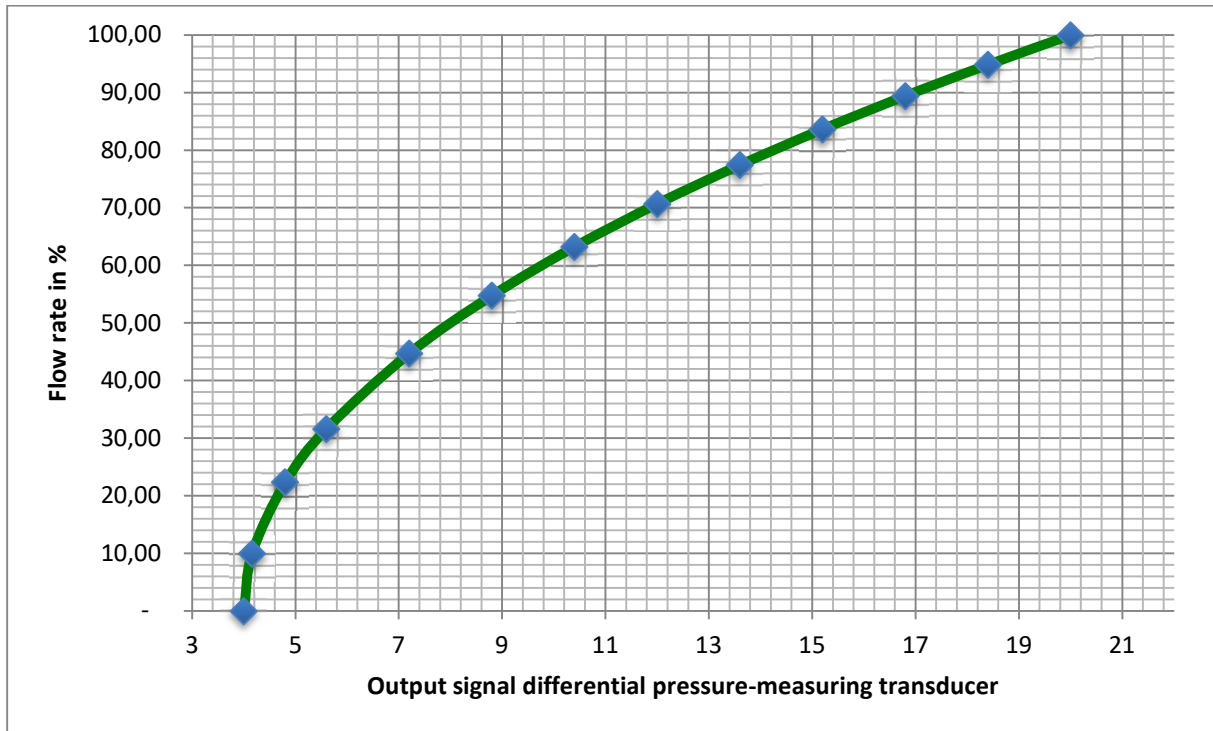

When using a root-extracting transmitter the transmission characteristic is of course a straight line.

S.K.I. Schlegel & Kremer Industrieautomation GmbH

PO Box 41 01 31
D-41241 Mönchengladbach

Hanns-Martin-Schleyer-Str. 22
D-41199 Mönchengladbach

Tel.: +49 (0) 2166/62317-0

Web: www.ski-gmbh.com

Email: info@ski-gmbh.com

Trademarks and logos are the property of their owners
Subject to technical changes. Illustrations may contain options