

Manual

MicroFlow MF 3000

Mass flow measuring system for solids

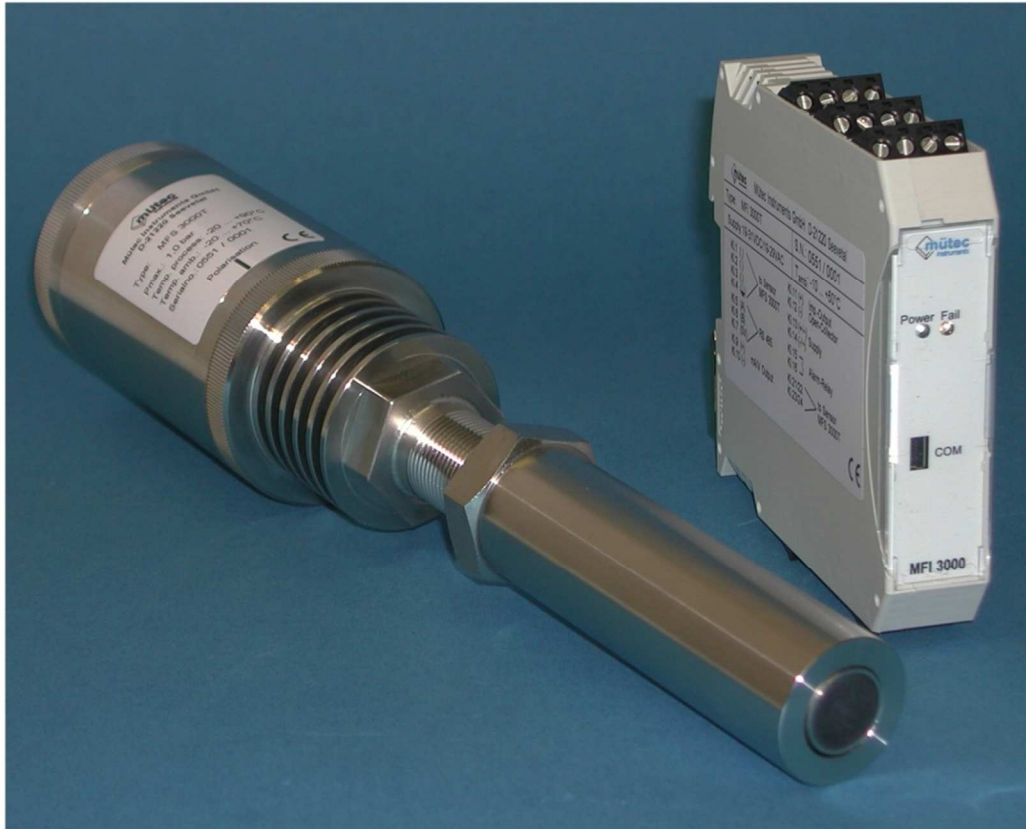

Manual for MF 3000

MF-SMART-program for calibration and parameterization

No. BA 4.011
Date: 10/2012

Manufacturer:

Mütec Instruments GmbH
Bei den Kämpfen 26
21220 Seevetal
Deutschland

Tel.: +49 (0) 4185 8083-0
Fax: +49 (0) 4185 808380

Email: info@muetec.de
Internet: www.muetec.de

Licence, trademark and copyright notes

Windows™ is a registered trademark of Microsoft Corp.

Copyright © Mütec Instruments GmbH 2010 All rights reserved

This document is copyright protected. It supports the user in making reliable and efficient use of the unit. Transmission and duplication of this document as well as utilization and disclosure of its content are prohibited unless expressly permitted. Any breach or infringement shall result in liability for damages. The software described in this document is licensed and may only be used and copied in accordance with the terms of the license.
All rights reserved.

Disclaimer

We have checked the content of the printed document for compliance with the described hardware and software. Nevertheless, deviations cannot be excluded and consequently we cannot assume any guarantee for complete accordance. The data in this printed document are checked regularly. Corrections and additions are made in the following version in each case. We would be grateful for any suggestions for improvement.

© Mütec Instruments GmbH

Subject to technical modifications

INDEX

Classification of the safety instructions	4
General instructions	5
1.0 General information for installation and operation	6
2.0 System structure	7
3.0 Function	8
4.0 Mounting and Assembly	9
5.0 Calibration of MF 3000	12
6.0 Technical data	13
7.0 Terminal connections	15
8.0 Configuration program MF-SMART	16
8.1 Read device settings	16
8.2 Products: Measurement	17
8.3 Products: Input calibration	18
8.4 Products: Digital outputs	20
8.5 Analog output	21
8.6 System	22

Classification of the safety instructions

This manual contains instructions that you have to observe for your personal safety as well as to avoid material damage. These instructions are highlighted using a triangular warning sign and shown as follows, depending on the degree of risk.



HAZARD

means that death or severe physical injury will occur if the appropriate precautionary measures are not taken.



WARNING

means that death or severe physical injury may occur if the appropriate precautionary measures are not taken.



CAUTION

with a triangular warning sign means that minor physical injury may occur if the appropriate precautionary measures are not taken.

CAUTION

without a triangular warning sign means that material damage may occur if the appropriate precautionary measures are not taken.



ATTENTION

means that an undesired result or state may ensue if the corresponding instruction is not followed.



NOTE

denotes important information about the product, handling of the product or the respective part of the documentation, is aimed at drawing special attention to the latter and should be complied with.

In addition to the instructions in this manual, the generally applicable safety and accident prevention regulations must be observed.

If the information contained in this document should not be sufficient in any specific case, you can obtain more detailed information from our telephone service.

Please read this manual carefully prior to installation and commissioning.

CE mark

This product meets the specifications according to the EMC-directive 2004/108/EG and the Low Voltage Directive 2006/95/EG.

General instructions

This device left the plant in flawless condition in terms of its safety features. To preserve this condition and ensure safe operation of the device, the user has to observe the instructions and warning notes indicated in this operating manual.

NOTE

For the sake of clarity the manual does not contain complete detailed information on all product types and can therefore not take into account every conceivable case with respect to installation, operation and maintenance.

Should you wish further information or should special problems arise that are not treated in sufficient detail in the manual, you can obtain the necessary information by telephone.

Moreover, we point out that the content of the manual shall not constitute part of or amend a previous or existing contract, agreement or legal relationship. All obligations of Mütec Instruments GmbH shall result from the respective contract of purchase, which also contains the complete and solely valid warranty terms. These contractual warranty terms shall neither be extended nor limited by the information contained in the manual.

The content reflects the technical state of the art regarding printing. It is subject to technical modifications in the course of further development.

WARNING

The device may only be used for the purposes specified in this operating manual.

DISCLAIMER

All modifications to the device fall within the responsibility of the user unless expressly specified otherwise in the operating manual.

Qualified PERSONNEL

are persons who are familiar with installation, assembly, repair and operation of the product and have the qualifications necessary for their work, such as:

- Training, instruction and/or authorization to operate and maintain equipment/systems in accordance with the standards of safety technology for electrical circuits, high pressures and corrosive as well as hazardous media.
- In the case of equipment with explosion protection: training, instruction and/or authorization to perform work on electrical circuits for potentially explosive equipment.
- Training or instruction in accordance with the standards of safety technology regarding care and use of appropriate safety equipment.

CAUTION

Potentially electrostatic components may be destroyed by voltage that is far below the limits of human perception. Such voltage occurs even when you touch a component or electrical connections of a component and are not electrostatically discharged. The damage that occurs to a component because of overvoltage usually cannot be detected immediately and does not become noticeable until after a longer operating period.



1.0 General information for installation and operation

Safety instructions:

If it is ascertained that safe and reliable operation is no longer possible, the device must be taken out of operation and secured against accidental operation.

Reasons for this can be:



- visible damage of the device
- failure of electrical function
- longer storage at temperatures over 85 °C
- heavy transport stress

Before the device can be put back into operation, a professional routine check must be performed in accordance with DIN EN 61010, Part 1. This examination should be made for reasons of safety and manufacturer warranties.

Proper Use

The MF3000 system consists of the sensor MFS 3000T and the transmitter MFI 3000 and is able to measure the mass flow of solids in free fall or pneumatic pipes.



The maximum permitted ambient temperature conditions for the sensor MFS 3000T are **-10 °C up to +70 °C**.
The maximum permitted process temperature conditions are **-20 °C up to +90 °C**.
The maximum permitted ambient temperature conditions for the transmitter **MFI 3000** are **-10 °C up to +60 °C**.

Installation and operation

The clamp connections with the not-intrinsically safe electric circuits are clearly characterized on the type plate.



For the safe operation a protective grounding connection to the sensor MFS 3000T has to be made, to firm an integration into the potential equalization.

The assembly/disassembly, installation, operation, and maintenance may be only performed by qualified personnel in the automation industry under appropriate regulations and the MF 3000 service manual.

The technical data and the power supply information must be observed during installation.

Maintenance:

The device maintenance should be done with a dry cloth and it is not allowed to use any solvents.

2.0 System structure

The MF 3000 System consists a cylindrical Flow-sensor with welding flange, a DIN-rail transmitter and software **MF-SMART**. The process interface occurs by the welding branch, in which the sensor is screwed flush with the inside of the pipe. The sensor is connected to the transmitter by 4-wire cable. The sensor contains an analog exit, an pulse exit, an alarm relay exit, one RS232 and two RS485 interfaces.

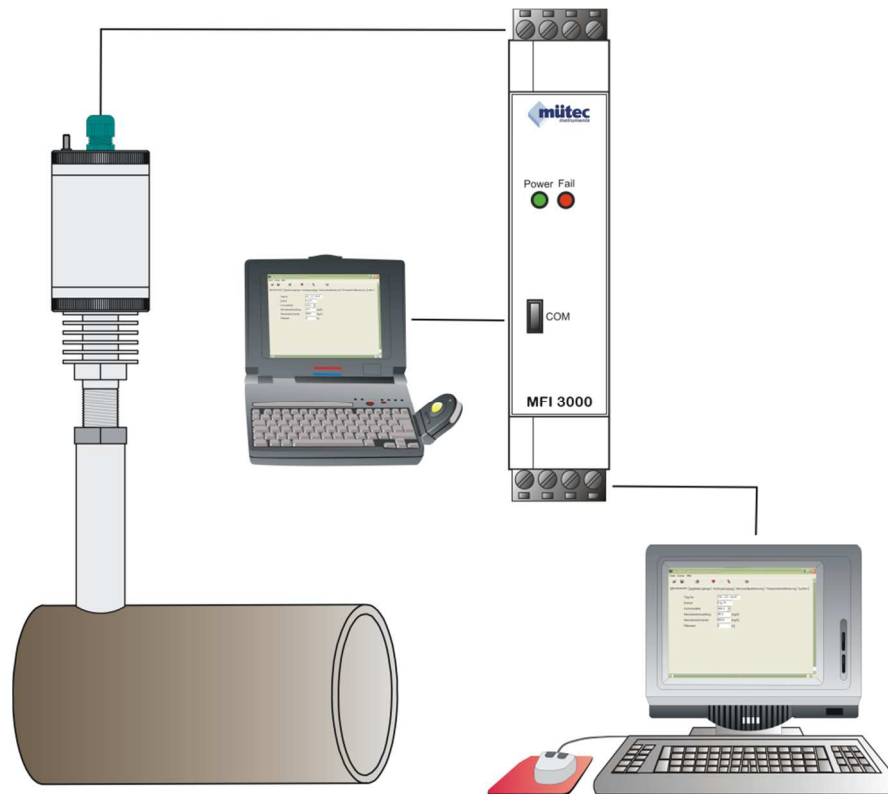

Fig. 1

Flow-Sensor MFS 3000T

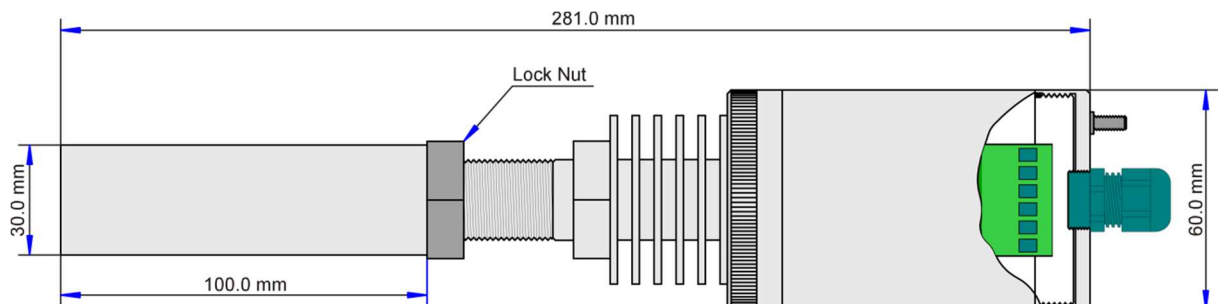

Fig. 2

3.0 Function

The MF 3000 system is conceived for the flow measuring of solid substances in metallic pipelines. It makes the flange mount possible at vertical pipes at the free fall transport and at horizontal pipes at the pneumatic material transport. Equipped with the newest microwave technology a modern PHEMT oscillator use the supply current reduces himself through what for the MF 3000T probe on some as 25 mA. The working frequency of the probe lies in the internationally free available frequency area between 24.00 ... 24.25 GHz, in which the sent out or the emitted top performance are less of 10 mW. A at the pipe welded installation flange, through which the pipe wall will be rebored afterwards, serves as a mechanical admission for the MF 3000T-Sensor. From the flush mounted MFS 3000T inside of the pipe, the micro wave will be radiated into the metallic pipeline which seems to be a measuring chamber.

The radiated wave fronts meet to the flowing solid substances and lead to a frequency displacement (Doppler effect) of the reflected signal. The intermediate frequency signals which frequency and amplitude are proportional to speed and size of the solid substance parts, will be collected and used as basic for the calculation of the solid substance quantity.

Deposits at the pipe wall will not influence the measurement.

Placed in a stainless steel housing, the measuring sensor and the heat valve will be connected to the MFI 3000 transmitter by a 4 wire line and can be parameterized and calibrated online by RS485 interface.

The raw measuring value of the solid substance quantity and the temperature will be transmitted for analyze to the MF 3000T transmitter. The result is available as a analogue value at 0/4-20mA- or 0/2-10 V- signal or as digital process value by the RS485 interface.

A passive pulse output enables the external integration of the solid substance quantity.

A relay output is used as the min/max/alarm or can be used for sensor monitoring.

After parameterization and calibration of the MF 3000 system, the measuring value can be observed at the online-mask or by using the data logger of the software **MF-SMART**.

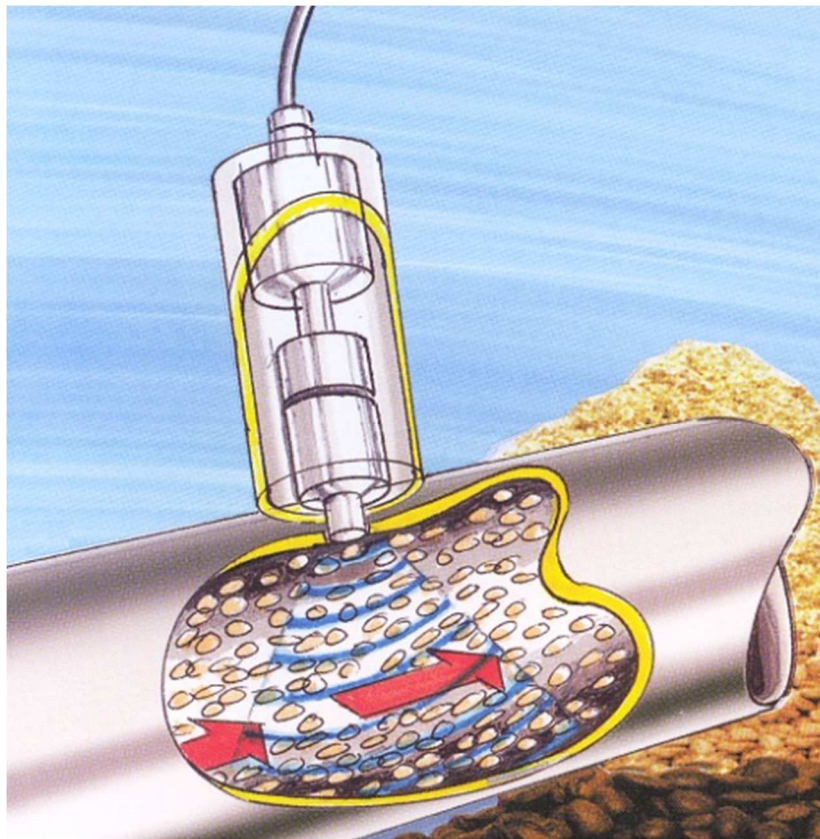

Fig. 3

4.0 Mounting and Assembly

Contents of delivery

- Flow-Sensor **MFS 3000T**
- Transmitter **MFI 3000**
- Software **MF-SMART** for Windows
- Interface cable
- Welding branch for **MFS 3000T**
- Installation manual

Preparation for sensor assembly

A welding device and a drill device (drill = 18 mm \varnothing) are needed for the installation. To the choice of the optimal installation place some important notes should be taken into account. The welding branch can be installed into a horizontal transport line or into a vertical free fall line.

The assembly is always expedient into a free fall line. The vertical line tracing has to be preferred upward in case of air conveying lines.

The following intake/discharge distance to **MFS 3000T** as a multiple of the nominal diameter (DN) shouldn't be fallen below.

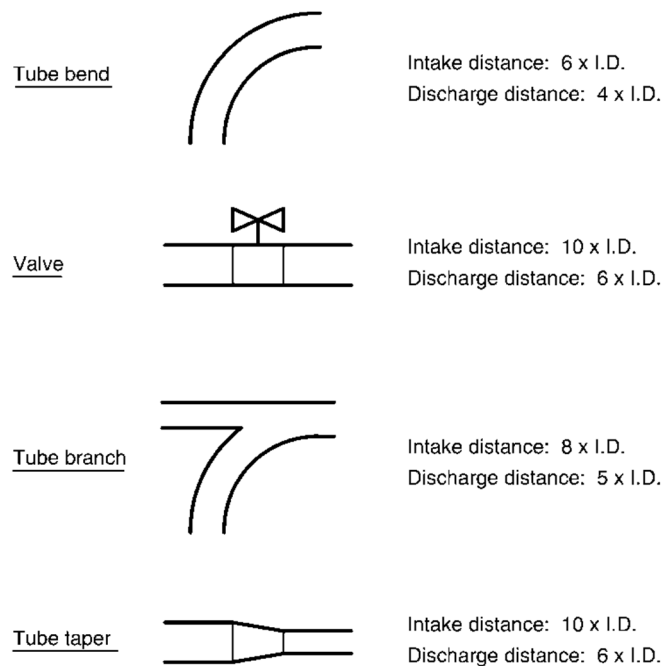

Fig. 4

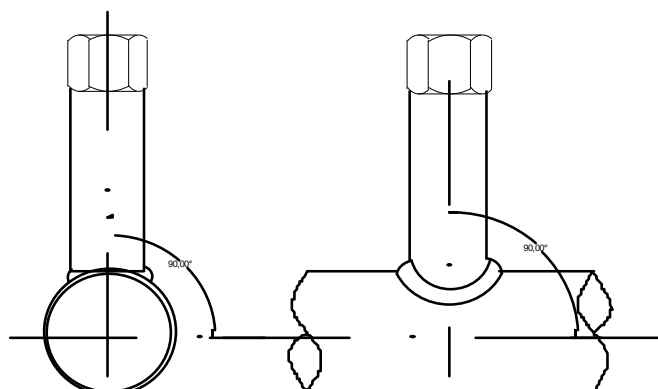

Fig. 5

The split between welding branch and pipe wall has to be closed by a weld seam after fixing the flow sensor flange vertical and in a 90° angle to the pipe axis.

With a following pressure examination can be checked the quality of the weld seam. For bore out the pipe wall for the necessary measuring window, an 18mm drill is needed. The welding branch which has been welded on before can be used as drilling jig. After bore out the drill hole has to be buried in order to avoid material deposits.

In a vertical pipe the flange will be placed horizontal and also in the 90° angle to the pipe axis.

Flow-Sensor-mounting

Before screw in the Flow-sensor into the welding branch the total depth of welding branch and pipe thickness will be marked at the shaft of the Flow-sensor.

The measuring window shall be flush mounted with the pipe wall so that it doesn't rise into the pipe. The screw in of the Flow-sensor into the welding branch occurs until the marked line. The use of teflon ribbon is recommended for the better insulation. The polarization axis indicated on the type plate is then taken to the cover with the pipe axis. A firm attracting of the jam nut (M32) on the thread shaft fixes the Flow-sensor permanently.

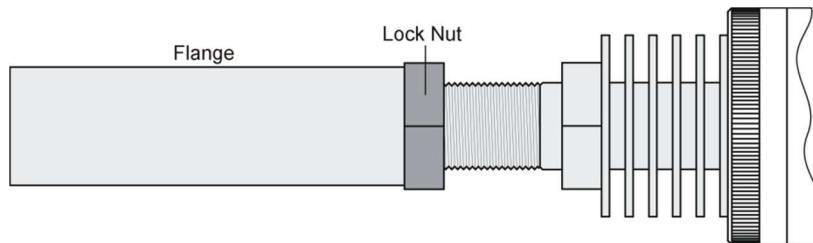

Fig. 6

Electrical connection and wiring

The DIN-rail transmitter MF 3000 always should be installed in a switch cupboard or dry room and it is to provide with 24V AC/DC. The electrical connection between the Flow-sensor and the transmitter has to be executed as a 4- line wire. For wire lengths up to 60 m a wire cross section of 0,75mm² is sufficient, beyond this it is necessary to have $\geq 1,0 \text{ mm}^2$ proportionally to wire length. A standard shielded cable can be used.



For an easy ground point connection, a PE-connection (M4 threaded bolt) is available at the housing.

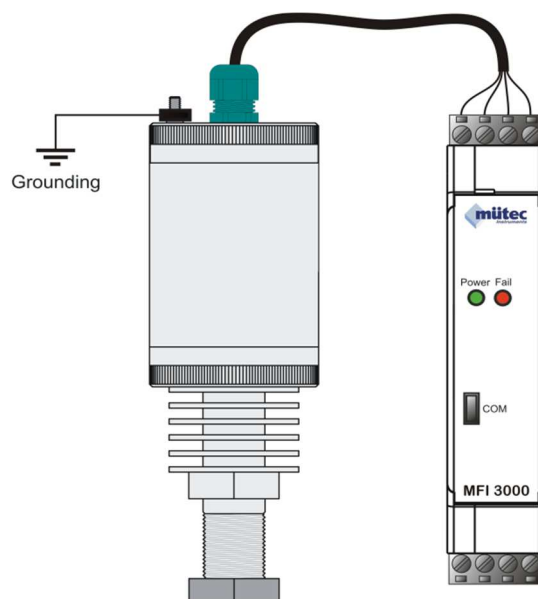

Fig. 7

In strongly disturbed surroundings or at long line lengths it is recommended the use of a cable with a shielded wiring. To avoid equipotential bonding current flowage via the shielded wiring it has to be grounded only at one end of the cable. For practical reason this should always be carried out on the transmitter side. For the wiring at the Flow-sensor the cable sheath and the shielded wiring must be removed. With a piece of shrinkage tube shoved about the end of the cable sufficient insulation of the shielded wiring to the screwed cable gland or housing is reached and an undesirable grounding contact can be avoided.

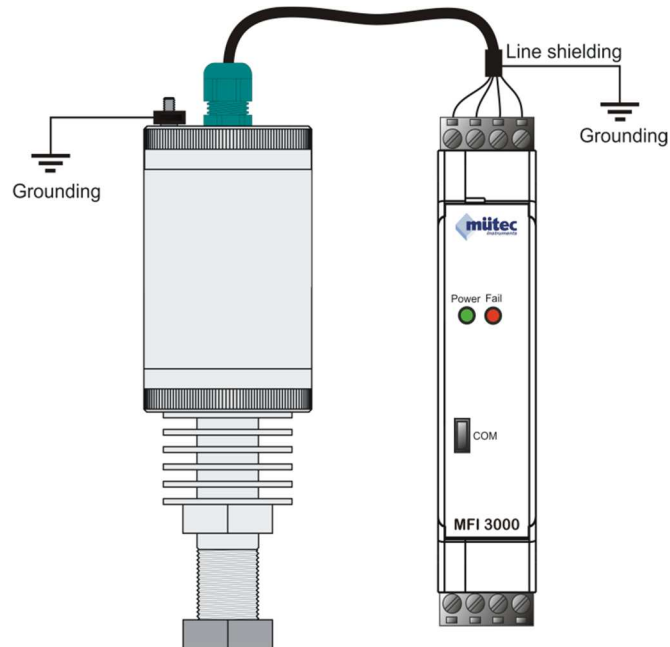

Fig. 8

5.0 Calibration of MF 3000

After installation of software **MF-SMART** on the PC it is possible to parameterize the MicroFlow. Afterwards the calibration for exact measurements is necessary. For that purpose it is necessary to have two or more reference measurements, for which quantities of the bulk material or weighing equipment are necessary.

In case of a **calibration** for 3 to max. 10 points with prepared quantities, different reference quantities or weighing equipment have to be available.

- Quantity 1 with constant pressure and constant speed, convey or put into the free fall pipe.
- The calibration routine for the first calibration point will be started with the installed software **MF-SMART** on the PC. Hereby a raw measuring value will be determined and coordinated to the real mass flow (the reference value) and registered. Same procedure with the second calibration point but with different quantity.
- For second calibration point and the second quantity, the way for proceeding is the same.

2-point-calibration linear characteristic curve:

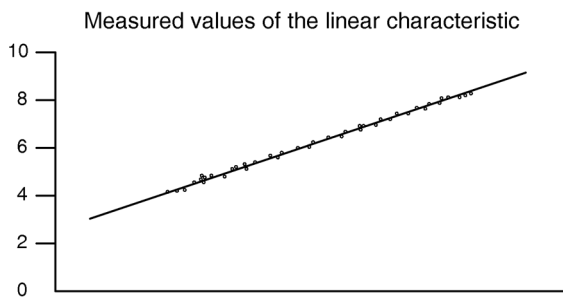

Fig. 9

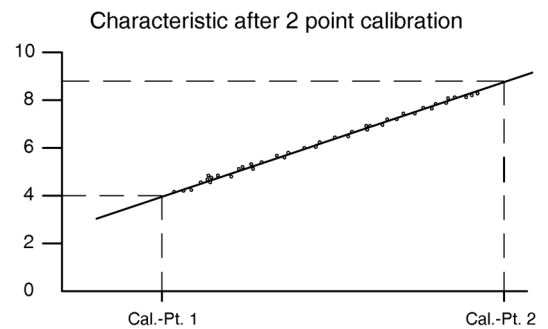

Fig. 10

Calibration of 3 points or more

In case of pneumatic and free fall conveyance the flow structure changes according to the conveyed quantity. Therefore the curve won't be a linear function in most areas of the measuring range. It has to be prescribed a linearization curve. Therefore up to 10 linearization points are available.

3-Point-calibration non linear characteristic curve:

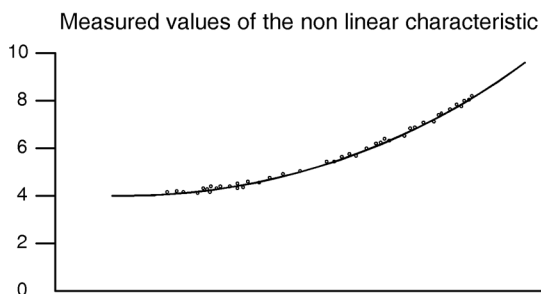

Fig. 11

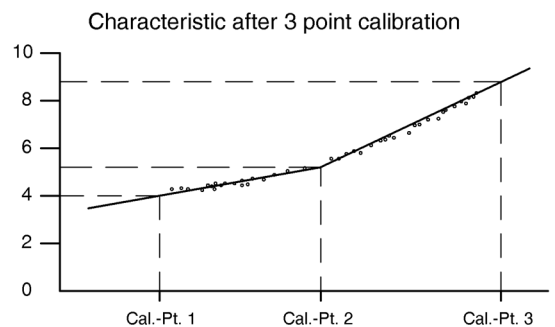

Fig. 12

6.0 Technical Data

Flow-Sensor MFS 3000

Medium touched parts:	Stainless steel 1.4307 and PA 6.6
Process connection:	Welding branch
Housing material:	Stainless steel 1.4307
Protection class:	IP 65
Ambient temperature:	-10 up to +70°C
Process temperature:	-20 up to +90°C

Transmitter MFI 3000

Analog output

<u>Current:</u>	0 ... 20 mA or 20 ... 0 mA
Initial value:	max. 22 mA
Load:	max. 750 Ω
Accuracy:	0.02 % of the final value
Load influence:	< 0.01 %
Response time:	< 150 ms
Damping:	filter 1st order for (0.1 – 99) s; adjustable

<u>Voltage:</u>	0 ... 10 V or 10 ... 0 mA
Initial value:	max. 11 V
Load:	min. 50 kΩ
Accuracy:	0.02 % of the final value
Load influence:	1 % at 50 kΩ
Response time:	< 150 ms
Damping:	filter 1st order for (0.1 -- 99) s; adjustable

Pulse output

Operational mode:	Open-Collector, open-circuit principle
Switching capacity:	≤ 1.4 W
Switching voltage:	≤ 28 VDC
Switching current:	≤ 50 mA
Pulse duration	≤ 50 ms

Alarm relay

Operational mode:	normally opened or normally closed
Alarm function:	MAX, MIN or Sensor fault
Fail-LED/red:	permanent light → limiting value alarm
Relay contact:	1 opener or closer
Switching capacity:	max. 60 VA by AC, max. 15 W by DC
Switching voltage:	max. 30 VDC or 125 VAC
Switching current:	max. 0.5 A
Min-Contact voltage:	10 mVDC
Min-Contact current:	10 μA
Contact material:	AG Pd + 10 μAu
Relay:	by IEC 947-5-1 / EN60947

Interfaces

RS232:	Front socket connection (Com) for PC/Notebook
RS485:	2400, 4800, 9600 or 19200 bps, device address: 1-255

Power supply

Type:	energy supply class A.C.3 or D.C.4 by IEC 654 part 2
AC:	24 VAC, -20% to +20 %, 50-60 Hz
DC:	24 VDC, -20 % to +30 %
Power consumption:	max. 2 W
Power-LED/green:	good-status of the supply

Electromagnetic Compatibility

The device filled the regulations of the EMV guideline 89/336/EC as well as the standard EN61326 from 1998 and the standard of EN61326/A1 from 1999.

More Data:

Alarm-LED:	slow blink → no sensor connection fast blink → FRAM-memory error
Form of construction:	Housing for 35 mm DIN rail (EN 50022)
Dimension:	22.5 x 99 x 114.5 mm
Ambient temperature:	-10 to +60°C
Form of protection:	IP 30
Weight:	150 g

Jumper-Configuration

Jumper JP1/2: Jumper JP1 and JP2 have to be closed for termination of RS485-interface.
 Jumper JP3: With Jumper JP3 occurs the change over at the analog output between constant current (JP3 open) or voltage (JP3 closed).

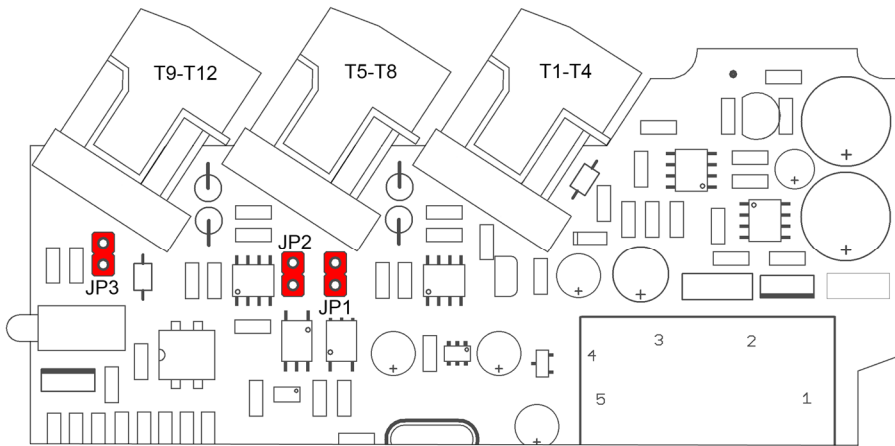

Fig. 13

Board of MFI 3000

Dimensions of the housing

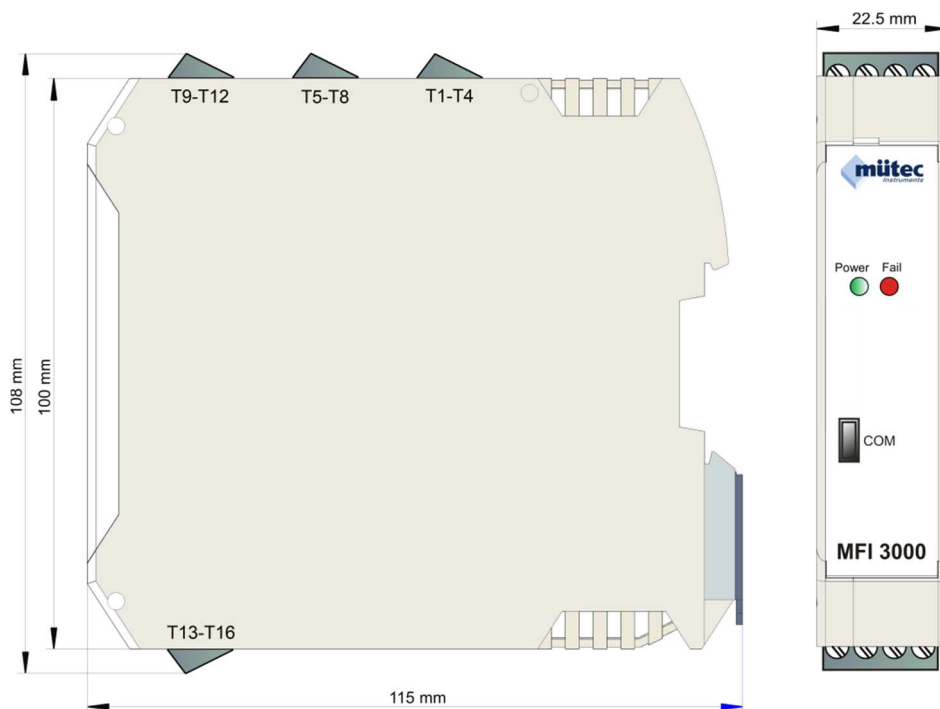

Fig. 14

Block diagram of MFI 3000

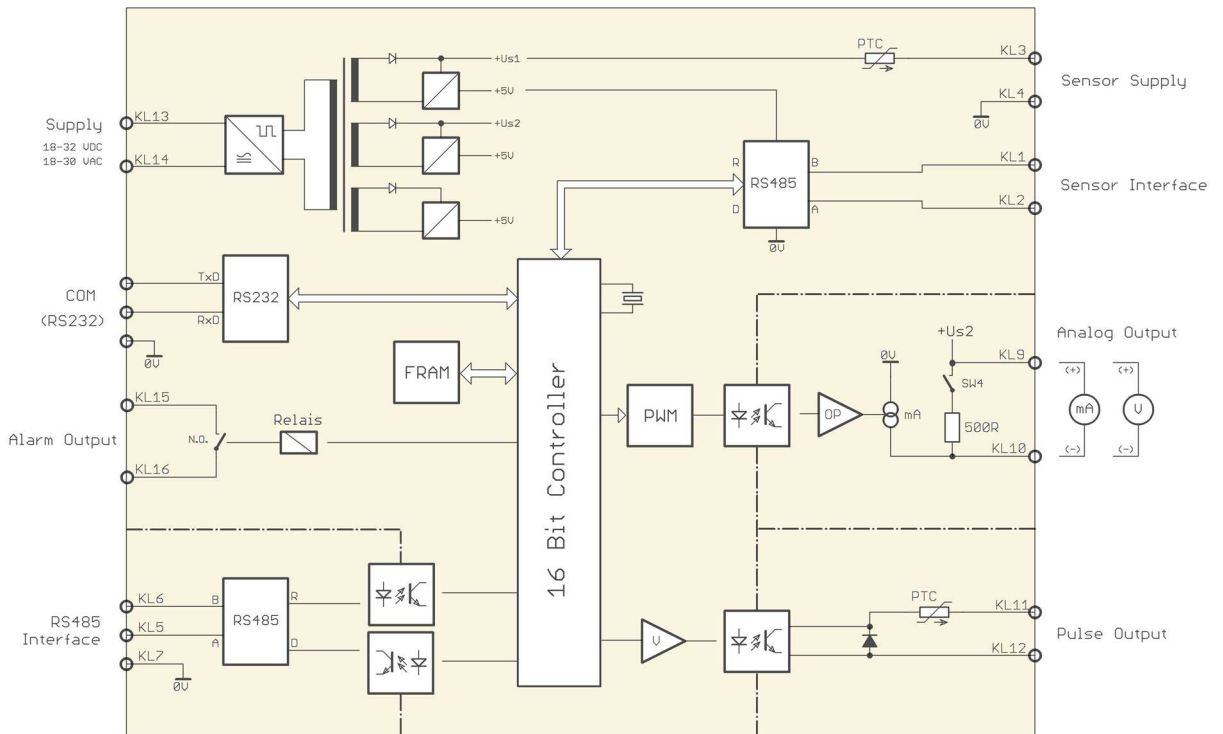

Fig. 15

7.0 Terminal connections

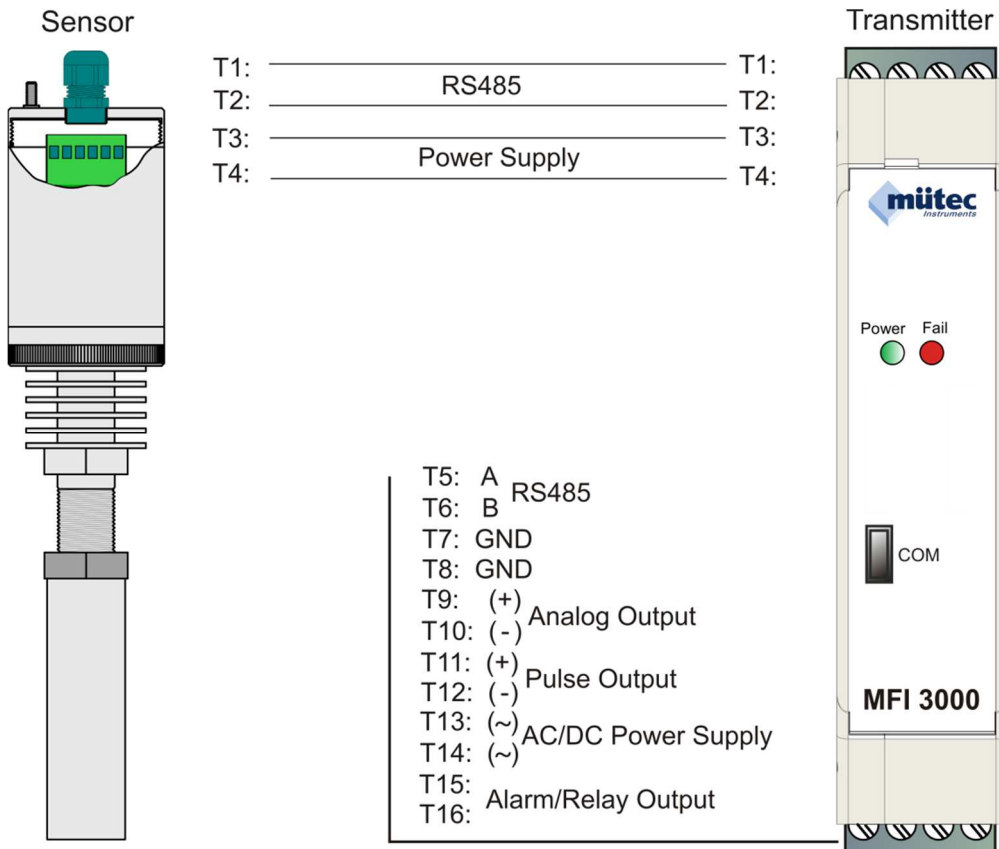

Fig. 16

8.0 Configuration program MF-SMART

8.1 Read device settings

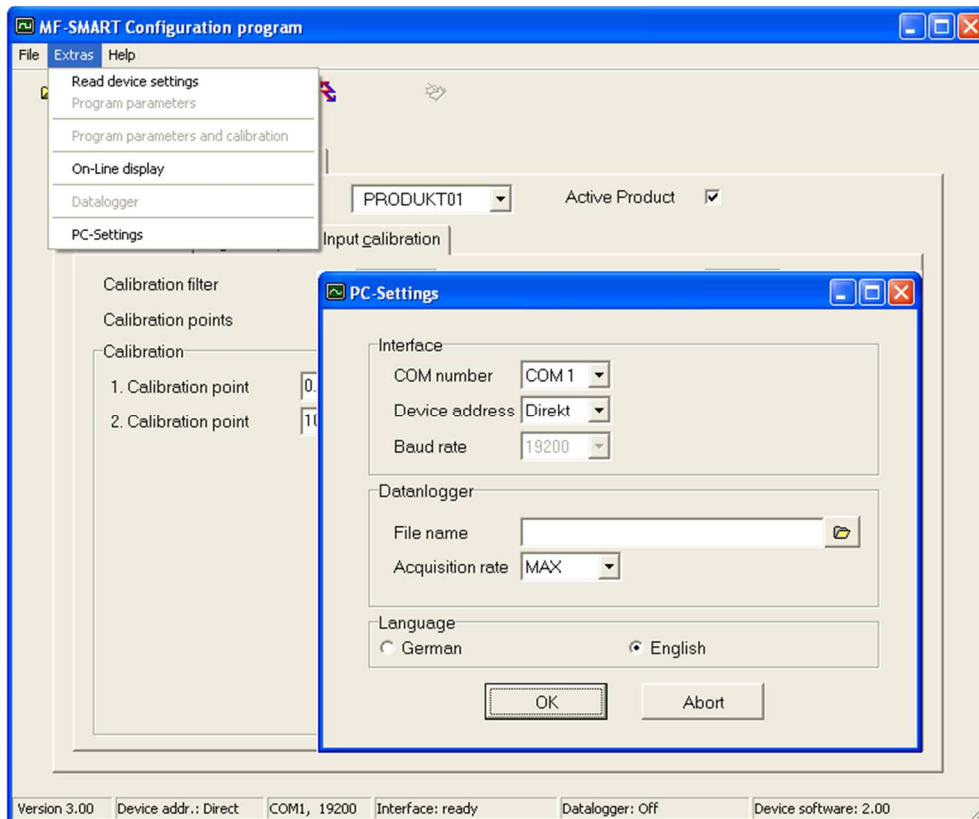

Fig. 17

Extras:

- | | | |
|---|---|--|
| Read device settings | - | read in all MFI 3000 - device data |
| Program parameters | - | write parameter from PC-program in MFI 3000 |
| Program parameters and calibration | - | Parameter and calibration values from PC-program write in MFI 3000 |
| Online-display | - | display with layout of raw measuring values (unfiltered + filtered) and integrator |

PC-Settings:

- | | | |
|------------------------|---|---|
| COM (RS232) | - | PC-interface with COM1 ... COM10 |
| Device address: | - | MFI 3000 -device address: direct |
| COM-Interface | - | MFI 3000 -device address: 1... 255 |
| RS485-Interface | - | 19200 bps (fixed) |
| Baud rate | - | |

Datalogger:

- | | | |
|-------------------------|---|--|
| File name | - | File name for stored measuring values |
| Acquisition rate | - | 5 measuring values/h, 20 measuring values/min to 1 measuring value/s (max) |

8.2 Products: measurement range

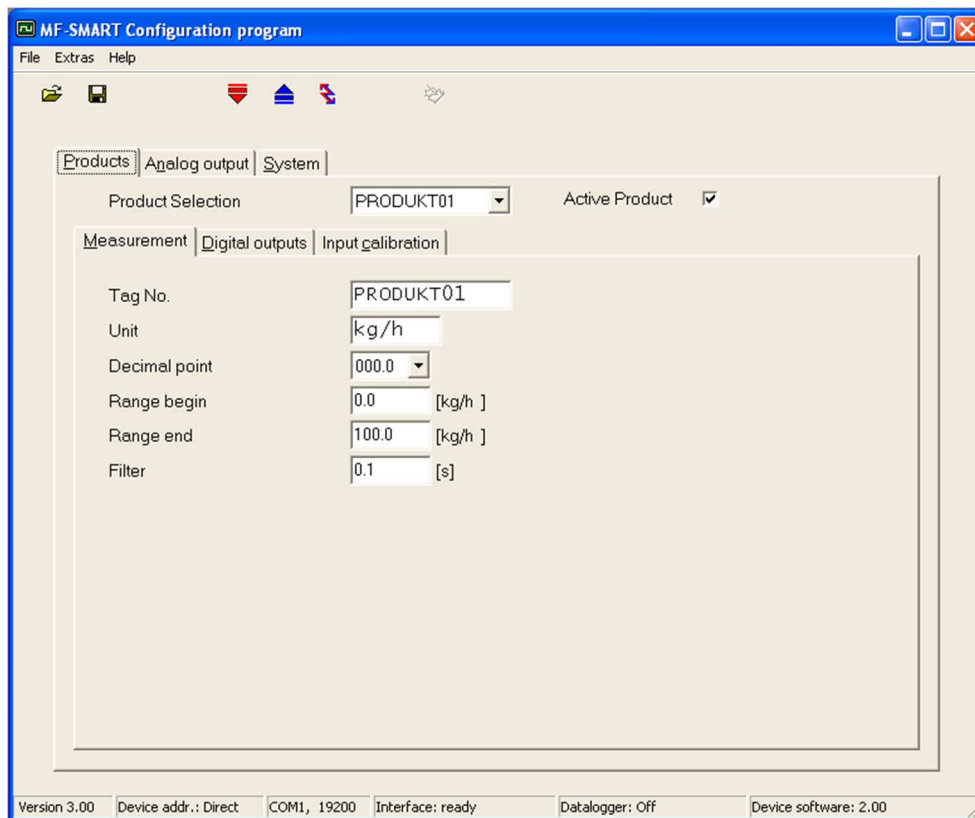

Fig. 18

The opening display of the **MF-SMART**-configuration program shows a well arranged presentation of all available displays for parameterization, calibration and online presentation.

Parameterization for measurement settings:

Product selection	-	Choice between 1 ... 24
Tag No.	-	Device-Nr. of MFI 3000
Unit	-	Measuring unit of flow rate
Decimal point	-	0 to max. 3 decimal places
Range begin	-	0 % - value of measuring range
Range end	-	100 % - value of measuring range
Filter	-	Filter 1. level between 1 ... 500 s adjustable

Informations about footnote:

Version 3.xx	-	MF-SMART program version
Device address	-	MODBUS-address: direct or 1 255
COM1, 19200	-	PC-interface COM-1 with Baud rate 19200 bps
Interface status	-	Status of PC-interface
Data logger	-	Data logger is off
Device software	-	Program version of MFI 3000

Changed parameter will be lost when you leave the screen mask. They will be transferred and stored through the instruction **program Extras/Parameter** in the MFI 3000.

Max. 6 characters are available for the text of measuring unit. Not used places must be filled out with blanks and have to be deleted first in case of later text change.

With each change of the decimal place an already-registered value shifts the measuring range start and end to a decade, so then is this to correct.

8.3 Products: Input calibration

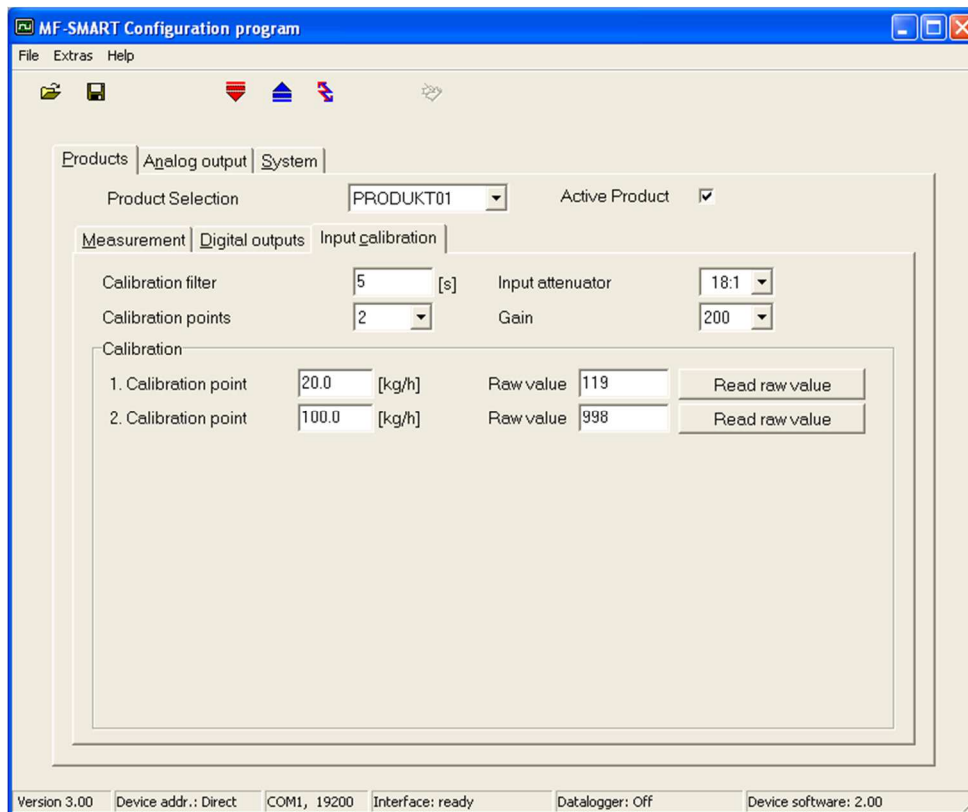

Fig. 19

Calibration of measuring value:

- | | | |
|--|---|---|
| Calibration filter | - | Filter 1. level adjustable between 1 ... 999 s |
| Number of calibration points | - | 2-points-calibration for linear characteristic line to 10-points-calibration for not linear characteristic line |
| Input attenuator | - | 4 dividing factor: 140:1, 70:1, 18:1 and 1:1 enable an optimal input signal adaption |
| Gain | - | a gain factor between min. 70 and max. 1280 is available |
| 1. / 2. Calibration point/
Read raw value | - | The raw value can be booked manually or by using the button collect calibration value automatically |

Any calibrating value in the calibration mask must be stored first, before in the screen mask one more button is pressed.
 Changed parameter and calibration values will be lost by leave the screen mask. They will be transferred and stored through the instruction **program Extras/Parameter and calibration** in the MFI 3000.

Important information about sensor calibration:

The measuring value will be digitalized by a 10-Bit ADC and can accept a value between 0 und 1023 Digit. In order to avoid a fraud of the characteristic line the product from input attenuator x gain has to be counted in the way that the available picture character of max. 1023 Digit will not be exceeded. For a high measuring accuracy, it should be used always the smallest input potential distributor and furthermore to keep small the adjustable gain factor. The selection of input attenuator and gain has to be orientated at the digital value at the end of the measuring range (100 % - value).

The tracking of the digital raw value will be made in the **Online**-display. Before the first calibration of a measuring value only the raw value is valid in the **Online**-display. The indicated results for the measuring value and analog output value have got a more or less great mistake and cannot be used for the rating of the equalization process. For adjustment of the measuring range by input attenuator and gain factor the 100 % value should be about 900 digit, in order to guarantee a high measuring value definition and also to get availability of about $1023 - 900 = 123$ digit for a measuring range – over range. After adjustment of the measuring range the calibration can be started. In case of a linear characteristic line, the first calibration point should be next to the start of the measuring range and the second calibration point at about 90 % of the measuring range.

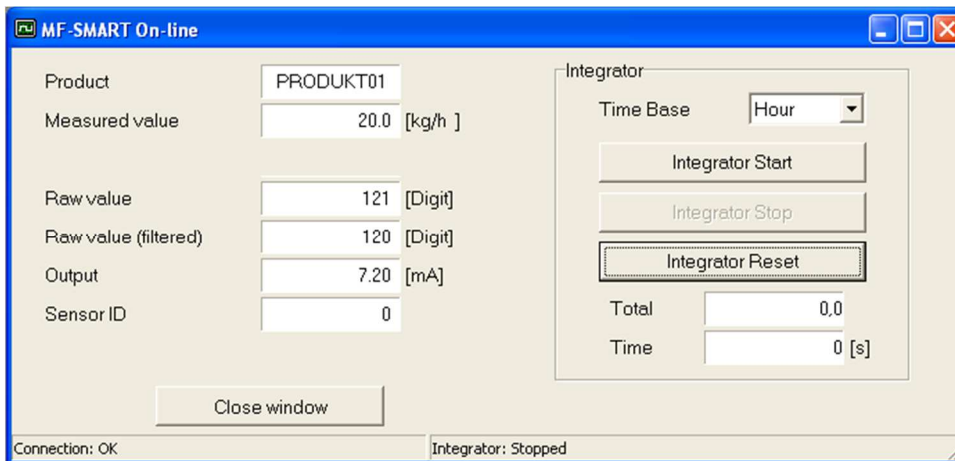

Fig. 20

Online mask:

Product	-	Product name
Measuring value	-	Parameterize quantity to be measured
Raw value	-	10 bit value of the measuring value
Raw value (filtered)	-	10 bit value of the measuring value after filtration
Output	-	Analog value
Sensor ID	-	Only as an option

Integrator:

Time Base	-	as time unit it is always necessary to adjust the defined time base in the display measuring range
Integrator Start	-	Start-button
Integrator Stop	-	Stop-button
Integrator Reset	-	Reset-button
Total	-	accumulated flow rate with the defined measuring Unit in the display measuring range
Time	-	Running period of integrator

The function of the integrator is only available during the opened screen mask of **MF-Smart**.

8.4 Products: Digital outputs

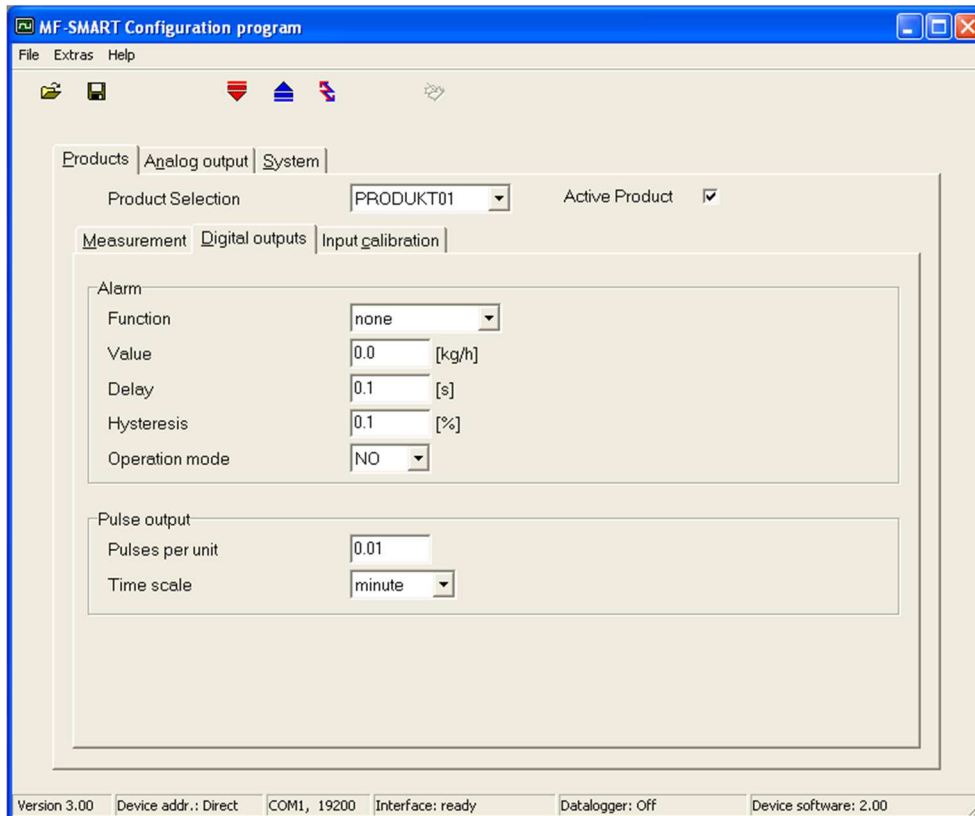

Fig. 21

Parameterization alarm output:

Function	-	MAX-, MIN- or sensor fault-alarm
Value	-	Triggering of MAX- or MIN-alarm
Delay	-	Alarm delay from 0.1 to 99.9 s
Hysteresis	-	0.1 % to 99.9 % of measuring range
Operation mode	-	NO = normally opened NC = normally closed

Parameterization pulse output:

Pulse per unit	-	Estimation of flow rate from min. 0.01 to max. 99.99 pulse per flow rate unit
Time scale	-	According to the time base booked in the screen mask of measuring range

Example:	Measuring range:	40. to 800.0 kg/h
	Pulse per unit:	10 Pulse/(kg/h)
	Time scale:	hour
=>	Pulse rate:	min. 400 Pulse/h to max. 8000 Pulse/h or min. 0.11 Pulse/s to max. 2.22 Pulse/s

The Pulse output should be parameterized in the way, that in case of a middle max. flow rate a pulse rate of 10 Pulse/s will not permanent exceeded.
 Changed parameter will be lost by leave the screen mask. They will be transferred and stored through the instruction **program Extras/Parameter** in the MFI 3000.

8.5 Analog output

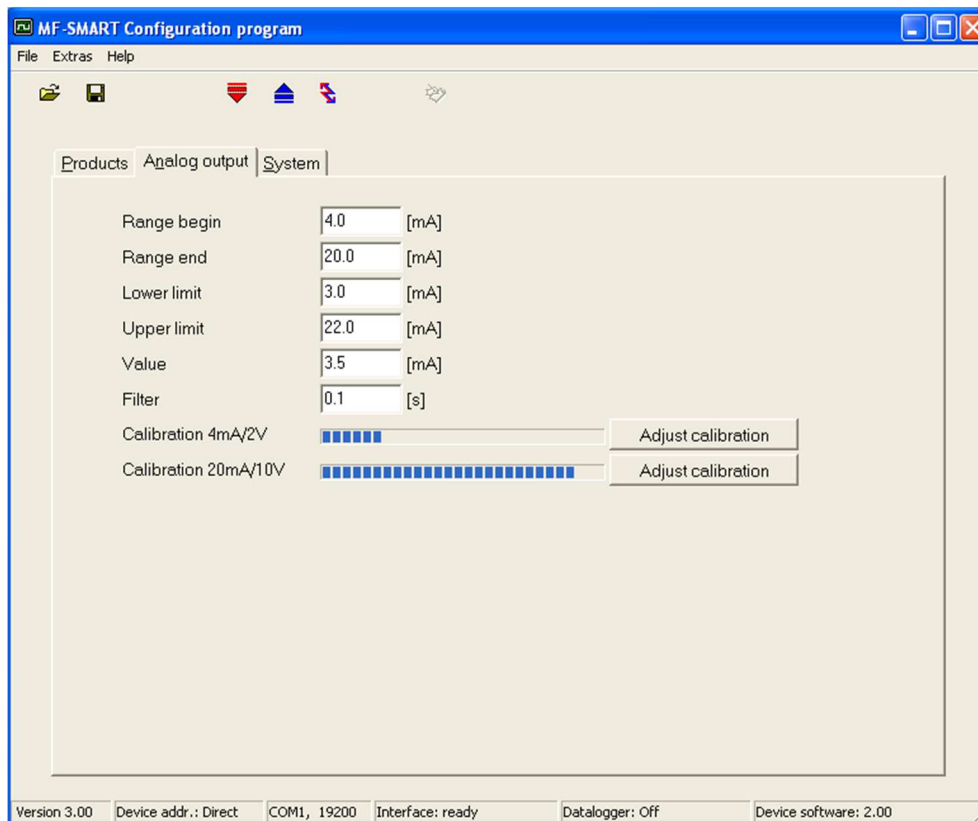

Fig. 22

Parameterization analog output:

Range begin	-	0 % - value analog output signal
Range end	-	100 % - value analog output signal
Lower-limit	-	minimal output signal
Upper-limit	-	maximal output signal
Value	-	output signal in case of no connection to flow-sensor
Filter	-	Filter 1. Level adjustable between 0.1 ... 99.9 s
Calibration 4mA/2V	-	After pushing the button adjust calibration the analog value-1 can be adjusted to 4.000 mA or 2.000 V and
Calibration 20mA/10V	-	the analog value-2 to 20.000 mA or 10.000 V.

Changed parameters will be lost by leave the screen mask. They will be transferred and stored through the instruction **program Extras/Parameter** in the **MFI 3000**.

Analog output with constant current: Jumper JP3 opened!
 Analog output with voltage signal: Jumper JP3 closed!

8.6 System

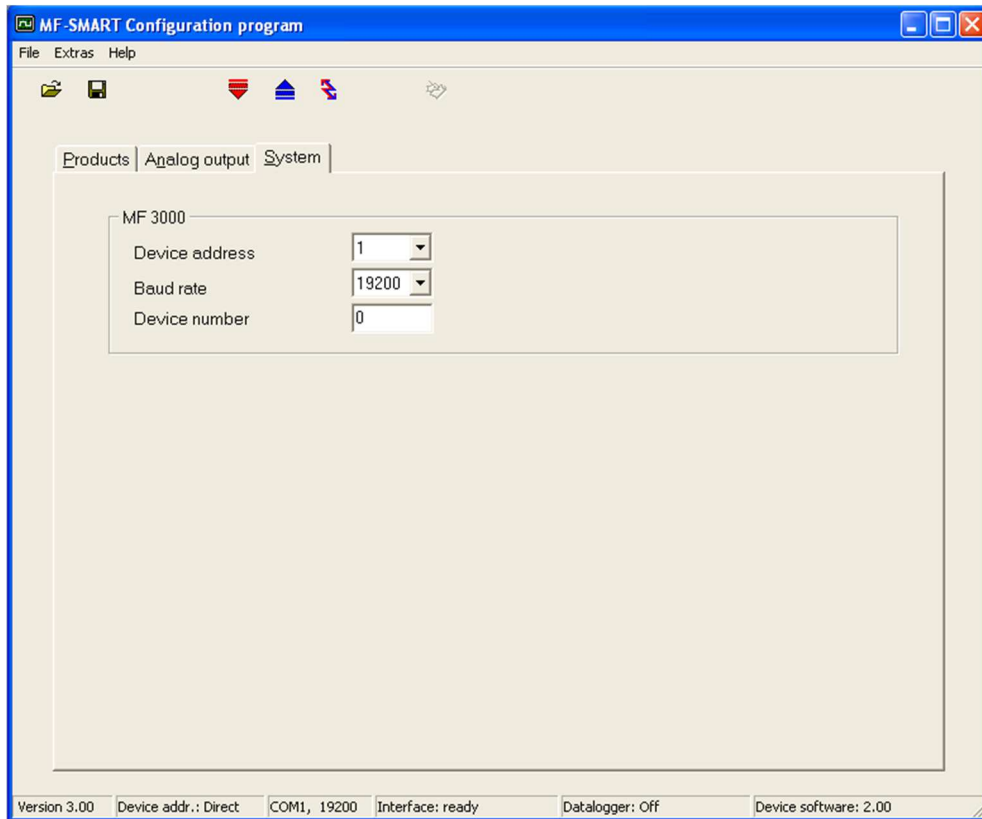

Fig. 23

MF 3000/RS485-Interface:

Device address	-	adjustable between 1 ... 255
Baud rate	-	adjustable between 2400 to 19200 bps
Device number	-	max. 8 characters
Protocol (fixed)	-	MODBUS/RTU-Mode

As part of a multi point connection to a PC or process control system, a system connection is available with the RS485 interface to the terminals T5/T6.

MF 3000/RS232-Interface:

With the **MF-SMART** program it is possible to access on all parameter and variables of the system via the COM-interface of **MFI 3000** devoid of adjusting interface parameters.

The update of changed baud rate-adjustments will be done after a system-reset through a short interruption of the power supply voltage.