

E3 Modulelevel®

Installation and Operating Manual



*Liquid Level
Displacer Transmitter*

UNPACKING

Unpack the instrument carefully. Make sure all components have been removed from the foam protection. Inspect all components for damage. Report any concealed damage to the carrier within 24 hours. Check the contents of the carton/crates against the packing slip and report any discrepancies to Magnetrol. Check the nameplate model number to be sure it agrees with the packing slip and purchase order. Check and record the serial number for future reference when ordering parts.



These units are in conformity with the provisions of:

1. The EMC Directive: 2014/30/EU.
The units have been tested to EN 61326:1997 + A1 + A2.

2. Directive 2014/34/EU for Equipment or protective system for use in potentially explosive atmospheres. EC-type examination certificate number ISSeP08ATEX021X (intrinsic safe units) or ISSeP08ATEX019 (Ex d units). The following harmonized standards have been applied: EN 60079-0:2006 / EN 60079-11:2007 / EN 60079-26:2004 / EN 60079-27:2006
3. The PED directive 2014/68/EU (pressure equipment directive). Safety accessories per category IV module H1.

TOP MOUNTED UNITS

After unpacking, inspect all components to see that no damage has occurred during shipment. Care should be taken not to bend the displacer stem or enclosing tube during unpacking or installation.

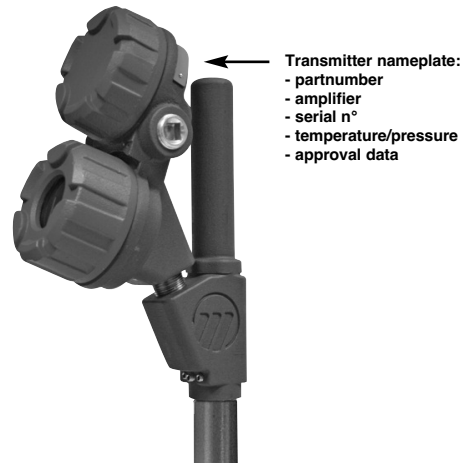

CHAMBERED UNITS

A strap and wire assembly retains and protects the displacer within the chamber during shipment. This assembly must be removed through bottom chamber connection before startup. Inspect instrument as described for top mounting units.

Caution:

If re-shipping to another location, displacer must again be secured using same strap and wire assembly.

PRINCIPLE OF OPERATION

LEVEL

Liquid level change acts upon the range spring supported displacer causing vertical motion of a core within a linear variable differential transformer (LVDT).

The enclosing tube acts as a static isolation barrier between the LVDT and the process media.

As core position changes with liquid level, voltages are induced in the secondary windings of the LVDT.

These signals are processed in the electronic circuitry and used to control the output signal.

INTERFACE

E3 Modulelevel is capable of tracking the interface level of two immiscible liquids with different densities. Each unit is custom-made with a displacer specially designed for the user's application. This allows it to detect the position of a clean interface or an emulsion layer and convert it into a stable output signal. Contact the factory for assistance in specifying an E3 for interface service. Note that for proper interface detection, the entire displacer must always be immersed in liquid.

DENSITY

Yet another capability of E3 Modulelevel is to track the changing density of a liquid over a known density range and convert that into a stable output signal. As the density of the liquid changes, so does the mass of the liquid displaced by the specially designed displacer. The resulting change in buoyancy force on the displacer causes the movement of the LVDT core necessary to convert the density change to the output signal.

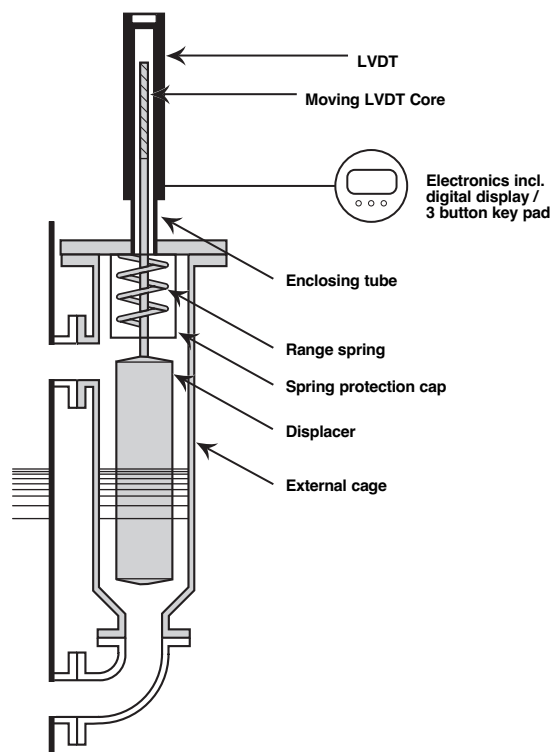

MOUNTING

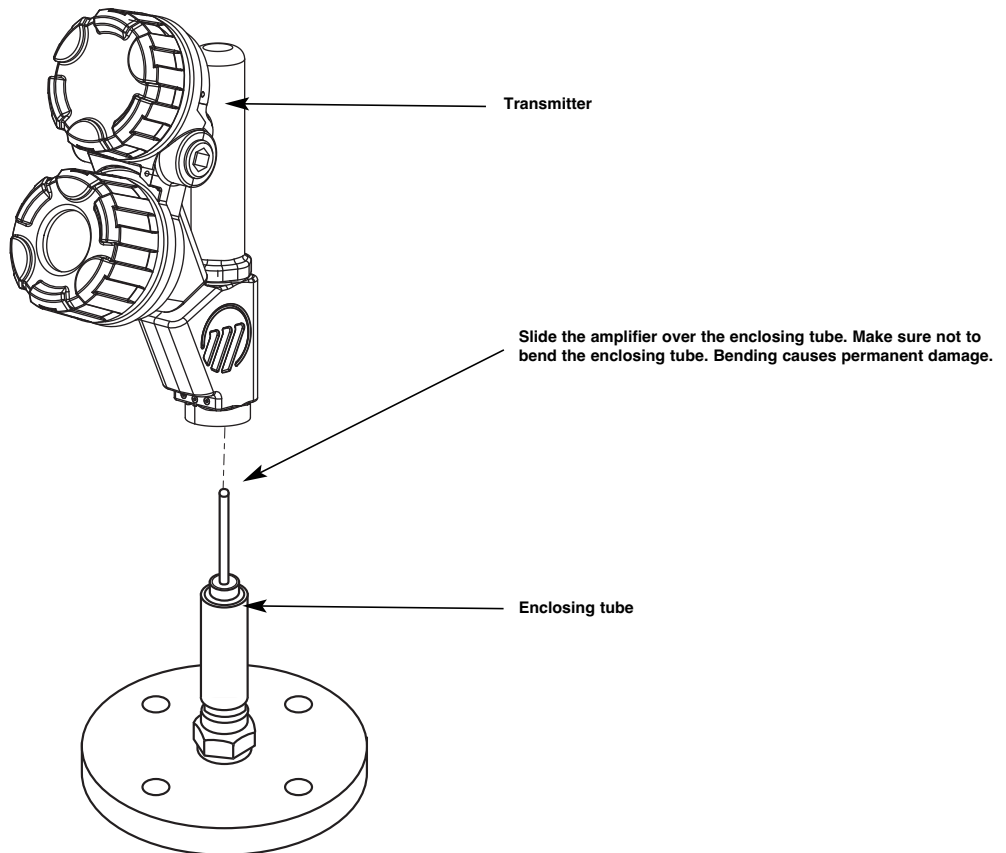
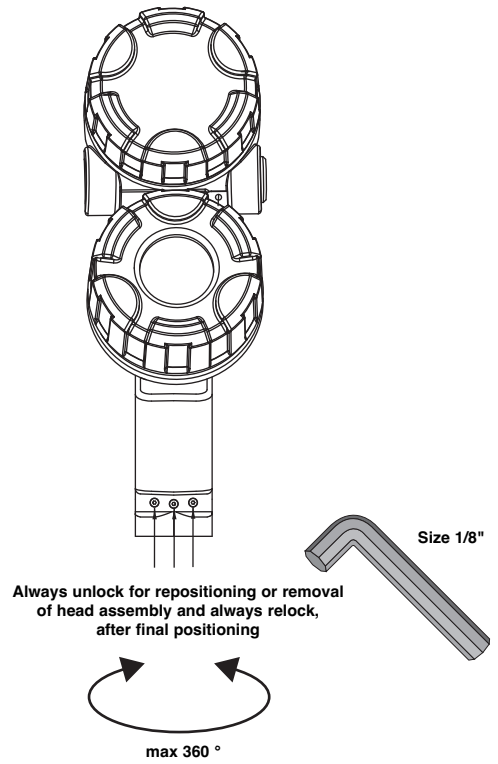
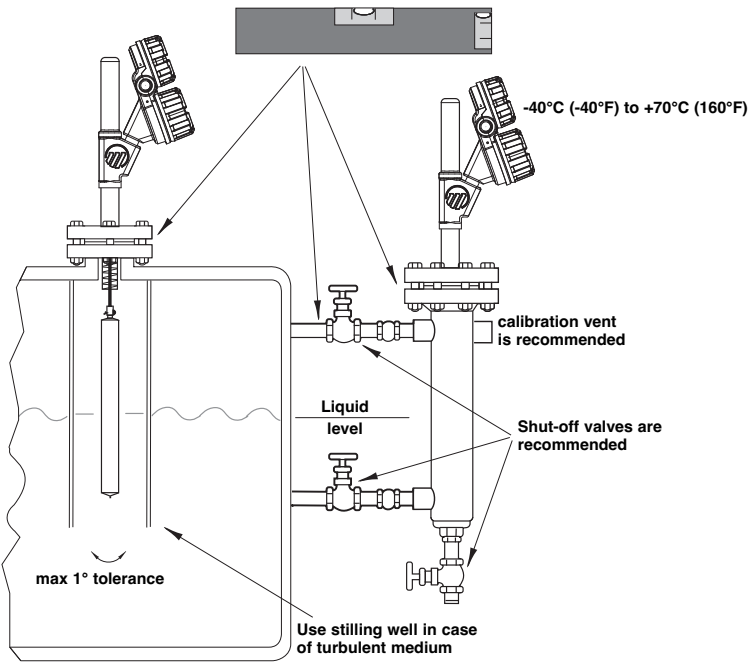

WIRING

CAUTION: power must be switched OFF before wiring the unit.

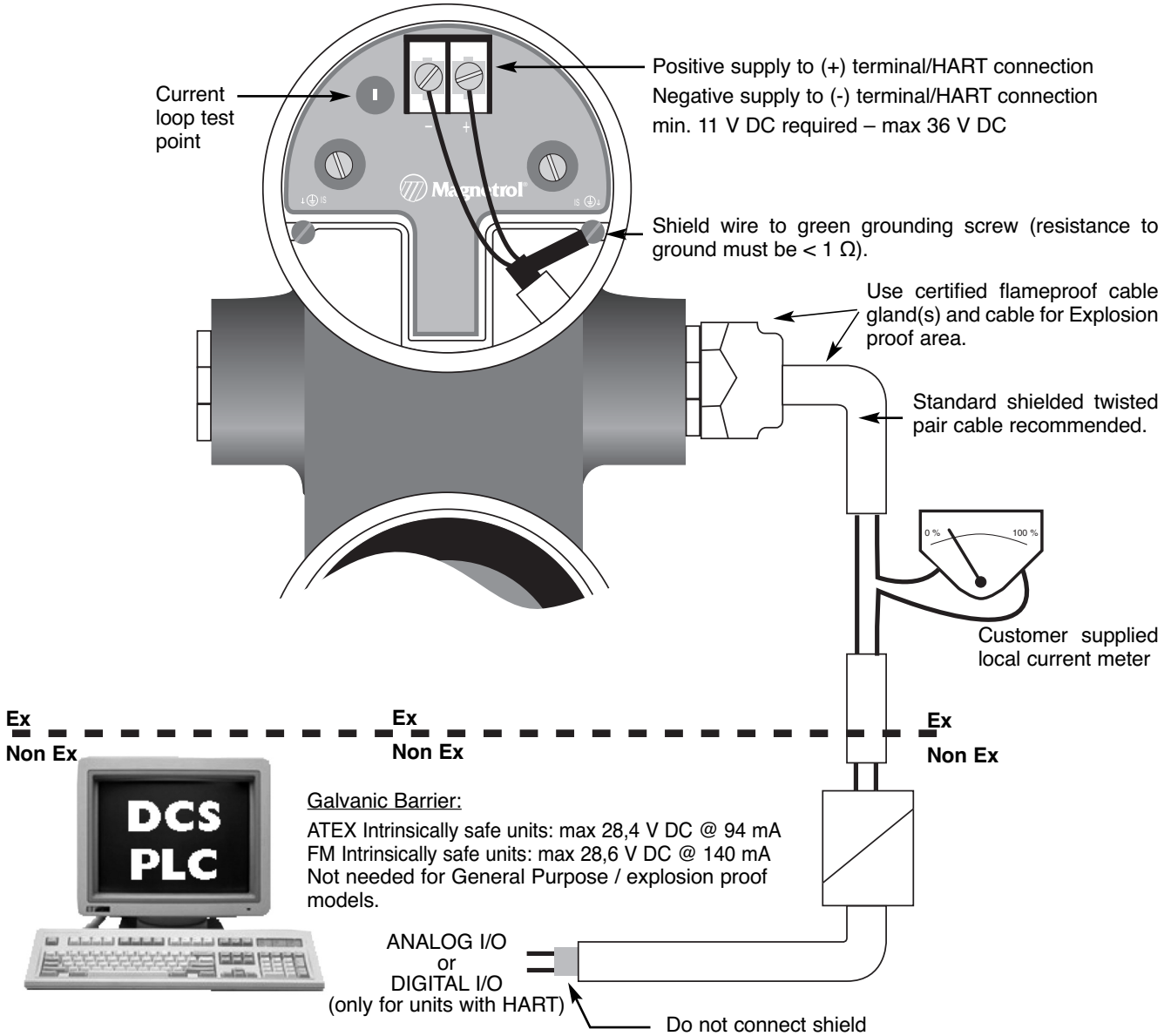

IMPORTANT:

The shield wire should only be grounded at ONE side only. It is recommended to connect the shield to ground in the field (at the transmitter side - as shown above) but connecting in the control room is also allowed.

REMOTE WIRING

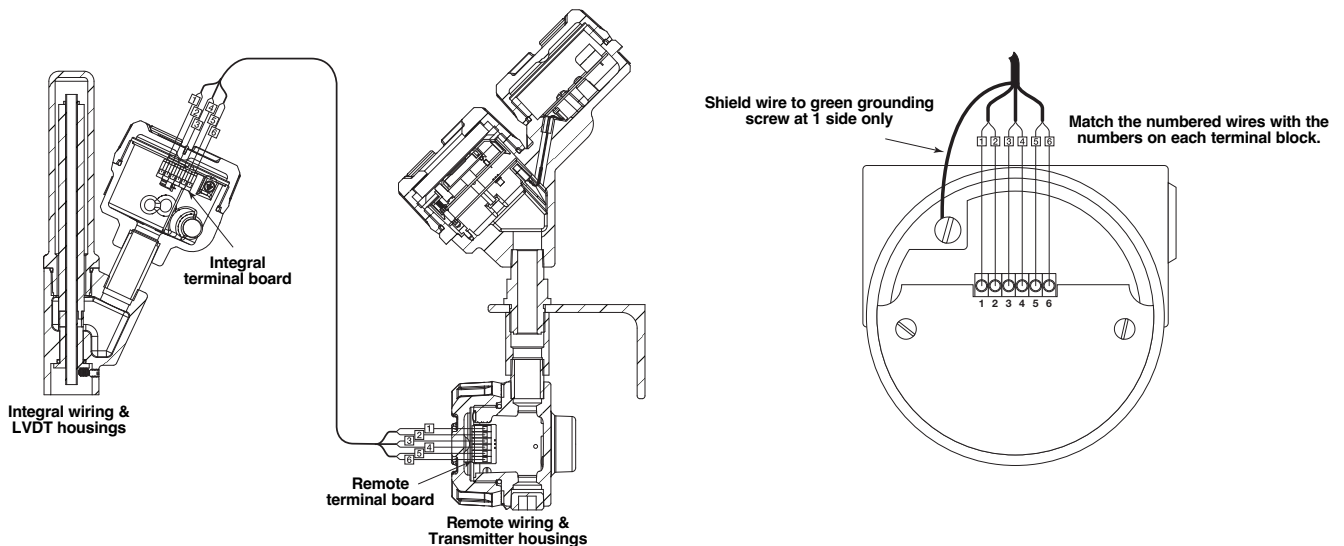

CONFIGURATION

NOTE: When connected to an approved barrier, the intrinsically safe electronics of the E3 Module level allow to remove the covers with power switched on – even if the area is known to be hazardous

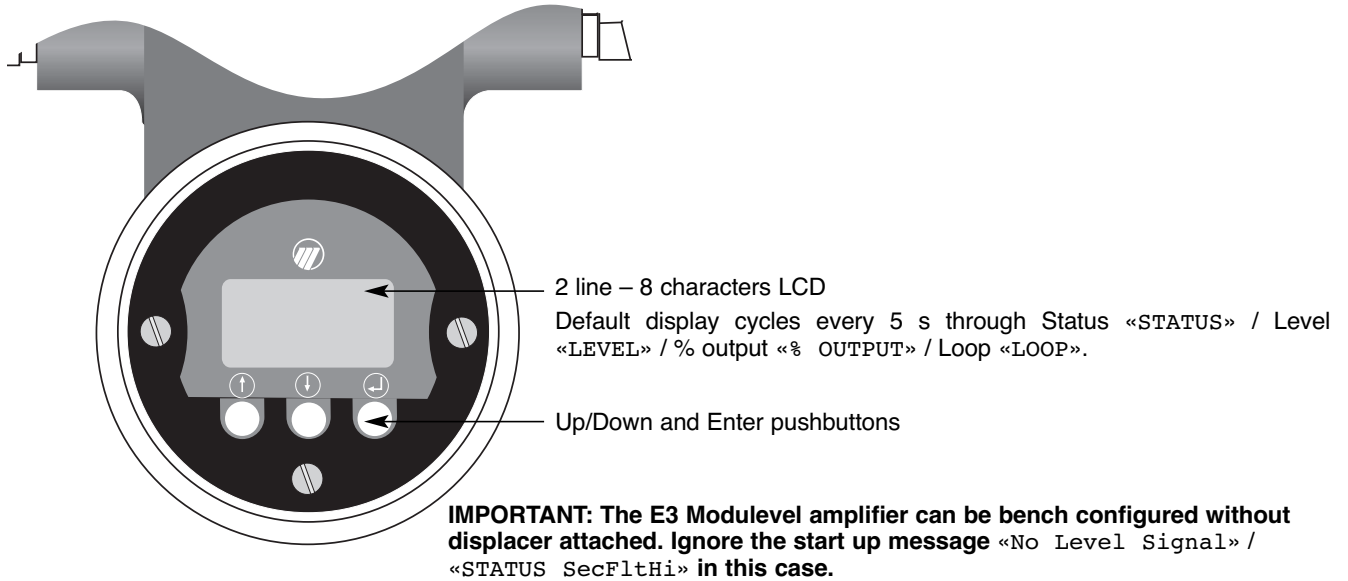

Display	Comment
Units! cm	Press ↵: The last character on the first line of the display changes to «!». This sign confirms that the values/choices of the second line can be modified via the ↓ and ↑ push buttons.
Units! cm	Press ↑ ↓ * Scroll through the choices or increase/decrease the values on the second line of the display by ↓ and ↑ pushbuttons. * Accept values/choices as selected by ↵ pushbutton.
Units cm	Press ↑ ↓ Scroll through the menu.

PASSWORD

DISPLAY	ACTION	COMMENT
Ent Pass 0	Display shows «0»	Factory default setting Data is not protected
Ent Pass! 1	Press ↵ and last character changes into «!» Enter your personal password with ↑ and ↓ (any value between 1 and 255) Press ↵ to confirm	Setting password
	Press ↵ and enter old password Press ↵ and last character changes into «!» Enter your new password with ↑ and ↓ (any value between 1 and 255) Press ↵ to confirm	Changing password
New Pass 4096	Display shows an encrypted value, enter your password or call Magnetrol for assistance to recoup your password if necessary	Data is protected by a valid Password

NOTE: Password protection is activated when after 5 minutes no keystrokes are sensed.



IMPORTANT:

Units are pre-calibrated at the factory with 4mA at the bottom of the displacer (free hanging position) and 20mA at the top of the displacer. If these settings match with the required settings, only enter

- density @ operating temperature «Proc SG» and
- operating temperature «OperTemp».

Wet calibration is recommended in case the correct 4-20 mA levels can be simulated. In this case, do not use the screens «set 4mA» and «Set 20mA» but proceed with the screens «Capture 4mA» and «Capture 20mA»

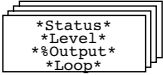
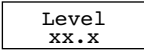
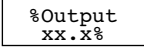
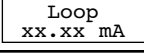
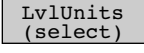
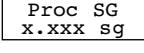
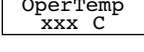
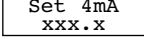
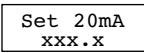
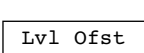
NOTE: For exchanging a new head or re-calibration of a unit with new spare parts, follow the User calibration procedure (see page 15).

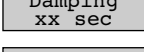
Screen	Action	Comment
Run mode	① 	Transmitter Display Transmitter default values cycle every 5 seconds. Status «Status», Level «Level», % Output «% Output», and Loop «Loop».
	② 	Transmitter Display Transmitter displays level value in selected engineering units.
	③ 	Transmitter Display Transmitter displays % Output measurement derived from 20 mA span.
	④ 	Transmitter Display Transmitter displays Loop measurement (mA).
Configuration	⑤ 	Select units for level cm «cm», m «m», inches «inches» or feet «feet».
	⑥ 	Enter the specific gravity of the process liquid at operating temp. Adjusts factory calibration for actual specific gravity.
	⑦ 	Enter the process operating temperature. Adjusts factory calibration for actual temperature.
	⑧ 	Enter the level value for the 4 mA point. Distance in cm or inches from typically the end of the displacer up to the 4mA (0%) level. If an offset value is used refer to the drawing at the right page.
	⑨ 	Enter the level value for the 20 mA point. Distance in cm or inches from typically the end of the displacer up to the 20mA (100%) level. If an offset value is used refer to the drawing at the right page.
	⑩ 	Enter the offset value When entering configuration values from the end of the displacer is cumbersome, an offset can be introduced to determine a new reference point. This reference point can be either below the displacer (positive offset) or at the displacer (negative offset).
	⑪ 	Enter the damping factor. A Damping factor (1-45 seconds) may be added to smooth a noisy display and/or output due to turbulence.
	⑫ 	Enter the value for error. Select «3.6 mA», «22 mA» or hold last value «HOLD». In case of loop failure, error signal will follow the failing trend; meaning the unit will show 3.6 mA when the reviewed loop current by the device is found too low. The unit will show 22 mA in case the reviewed loop current is found too high.



= Wet calibration procedure - see also pages 12 & 13

Screen	Action	Comment
⑬ Poll Adr xx	Enter HART ID number.	Select a HART poll address (0-15). Enter 0 for a single transmitter installation.
⑭ Trim Lvl xx.x	Enter value to adjust level reading.	Allows to compensate for a fixed level deviation.
⑮ Trim 4 xxxx	Fine tune the 4 mA point.	Attach a mA meter to the output. If the output does not equal 4.0 mA, adjust the value on the display to equal 4.00 mA.
⑯ Trim 20 xxxx	Fine tune the 20 mA point.	Attach a mA meter to the output. If the output does not equal 20.0 mA, adjust the value on the display to equal 20.00 mA.
⑰ Loop Tst xx.x mA	Enter a mA output value.	Set mA Output to any given value to perform loop test.
⑱ Capture 4.00 mA	Bring liquid level at desired 4 mA point. Press Enter to enter manual setting mode. Press up arrow + Enter (simultaneously) to confirm 4 mA level.	Manual setting of 4 mA output signal: free hanging displacer or level at the lowest level.
⑲ Capture 20.00 mA	Bring liquid level at highest possible point. Press Enter to enter manual setting mode. Press up arrow + Enter (simultaneously) to confirm 20 mA level. Note: in case of full span cannot be reached, adjust loop readout to current level (see at right).	Level is ideally brought to match with 20 mA point. If this is not possible, bring level to the highest possible position (should correspond with min 8 mA). Attach a mA meter and adjust the loop current via the keypad (down & up arrows) to match with the calculated mA value of the current level.
⑳ New Pass xxx	Enter new password.	Use arrows to select desired value. Values between 0 and 255.
㉑ Language	Select language.	Select «English», «Français», «Deutsch» or «Espagnol».
㉒ E3 ModHT Ver xx.xx	None, do not adjust.	Factory setting. «Ver» refers to software version.
㉓ DispFact (select)	Advanced diagnostics.	See page 15.

OFFSET

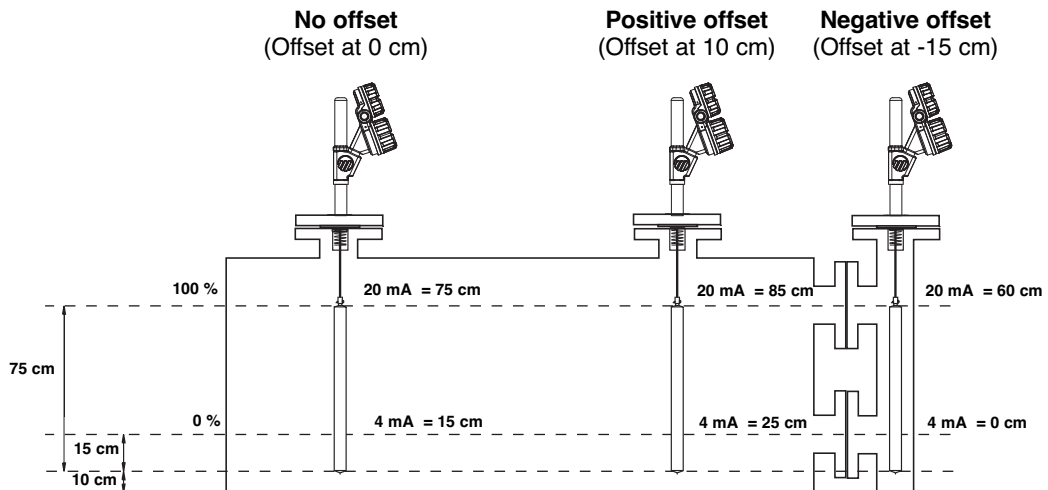

IMPORTANT:

Units are pre-calibrated at the factory with 4mA at the bottom of the displacer (free hanging position) and 20mA at the top of the displacer. If these settings match with the required settings, only enter operating temperature «OperTemp». The displacer is specifically designed for the application and does not require any density setting.

Wet calibration is recommended in case the correct 4-20 mA levels can be simulated. In this case, do not use the screens «set 4mA» and «Set 20mA» but proceed with the screens «Capture 4mA» and «Capture 20mA».

Correct output assumes that the displacer is at all times fully immersed in the liquid level (min. 50 mm (2")). See page 12 for proper guidelines.

NOTE: For exchanging a new head or re-calibration of a unit with new spare parts, follow the User calibration procedure (see page 15).

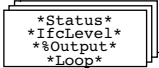
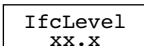
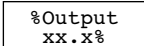
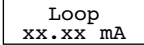
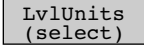
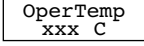
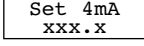
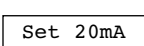
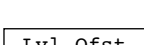
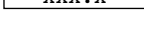
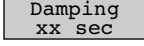
Screen	Action	Comment	
Run mode	① 	Transmitter Display	Transmitter default values cycle every 5 seconds. Status «Status», Interface level «IfcLevel», % Output «% Output», and Loop «Loop».
	② 	Transmitter Display	Transmitter displays interface level in selected engineering units.
	③ 	Transmitter Display	Transmitter displays % Output measurement derived from 20 mA span.
	④ 	Transmitter Display	Transmitter displays Loop measurement (mA).
Configuration	⑤ 	Select units for level	cm «cm», m «m», inches «inches» or feet «feet».
	⑥ 	Enter the process operating temperature.	Adjusts factory calibration for actual temperature.
	⑦ 	Enter the level value for the 4 mA point.	Distance in cm or inches from typically the end of the displacer up to the 4mA (0%) level. If an offset value is used refer to the drawing at the right page.
	⑧ 	Enter the level value for the 20 mA point.	Distance in cm or inches from typically the end of the displacer up to the 20mA (100%) level. If an offset value is used refer to the drawing at the right page.
	⑨ 	Enter the offset value	When entering configuration values from the end of the displacer is cumbersome, an offset can be introduced to determine a new reference point. This reference point can be either below the displacer (positive offset) or at the displacer (negative offset).
	⑩ 	Enter the damping factor.	A Damping factor (1-45 seconds) may be added to smooth a noisy display and/or output due to turbulence.
	⑪ 	Enter the value for error.	Select «3.6 mA», «22 mA» or hold last value «HOLD». In case of loop failure, error signal will follow the failing trend; meaning the unit will show 3.6 mA when the reviewed loop current by the device is found too low. The unit will show 22 mA in case the reviewed loop current is found too high.



= Wet calibration procedure. See also pages 12 & 13

Screen	Action	Comment
12 Poll Adr xx	Enter HART ID number.	Select a HART poll address (0-15). Enter 0 for a single transmitter installation.
13 Trim Lvl xx.x	Enter value to adjust level reading.	Allows to compensate for a fixed level deviation.
14 Trim 4 xxxx	Fine tune the 4 mA point.	Attach a mA meter to the output. If the output does not equal 4.0 mA, adjust the value on the display to equal 4.00 mA.
15 Trim 20 xxxx	Fine tune the 20 mA point.	Attach a mA meter to the output. If the output does not equal 20.0 mA, adjust the value on the display to equal 20.00 mA.
16 Loop Tst xx.x mA	Enter a mA output value.	Set mA Output to any given value to perform loop test.
17 Capture 4.00 mA	Bring interface level at desired 4 mA point, make sure that the displacer remains fully immersed in the upper liquid layer. Press Enter to enter manual setting mode. Press up arrow + Enter (simultaneously) to confirm 4 mA interface level.	Manual setting of 4 mA output signal. See drawing on page 12.
18 Capture 20.00 mA	Bring interface level at highest possible point, make sure that the displacer remains fully immersed in the upper liquid layer. Press Enter to enter manual setting mode. Press up arrow + Enter (simultaneously) to confirm 20 mA interface level. Note: in case of full span cannot be reached, adjust loop readout to current level (see at right).	Interface level is ideally brought to the level that matches with 20 mA point. If this is not possible, bring the interface level to the highest possible position (should correspond with min 8 mA). Attach a mA meter and adjust the loop current via the keypad (down & up arrows) to match with the calculated mA value of the current interface level.
19 New Pass xxx	Enter new password.	Use arrows to select desired value. Values between 0 and 255.
20 Language	Select language.	Select «English», «Français», «Deutsch» or «Espagnol».
21 E3 ModHT Ver xx.xx	None, do not adjust.	Factory setting. «Ver» refers to software version.
22 DispFact (select)	Advanced diagnostics.	See page 15.

OFFSET

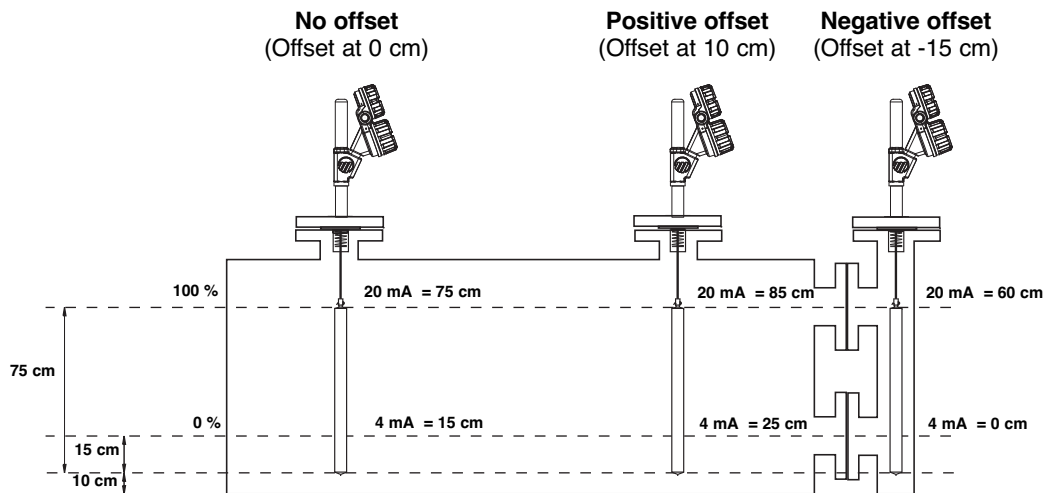





IMPORTANT:

Units are pre-calibrated at the factory with 4mA at the bottom of the displacer (free hanging position) and 20mA at the top of the displacer. If these settings match with the required settings, only enter operating temperature «OperTemp». The displacer is specifically designed for the application and does not require any density setting.

Wet calibration is recommended in case the correct 4-20 mA levels can be simulated. In this case, do not use the screens «set 4mA» and «Set 20mA» but proceed with the screens «Capture 4mA» and «Capture 20mA».

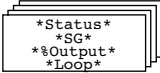
Correct output assumes no shift in level and the displacer at all times fully immersed in the liquid level (min. 50 mm (2")). See page 12 for proper guidelines.

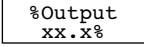
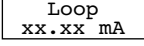
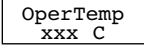
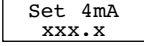
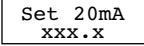
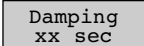
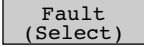
NOTE: For exchanging a new head or re-calibration of a unit with new spare parts, follow the User calibration procedure (see page 15).

	Screen	Action	Comment
Run mode	① 	Transmitter Display	Transmitter default values cycle every 5 seconds. Status «Status», Density «SG», % Output «% Output», and Loop «Loop».
	② 	Transmitter Display	Transmitter displays Interface volume or interface level in selected engineering units (depending selection in Loop control «Loop Ctrl»)
	③ 	Transmitter Display	Transmitter displays % Output measurement derived from 20 mA span.
	④ 	Transmitter Display	Transmitter displays Loop measurement (mA).
Configuration	⑤ 	Enter the process operating temperature.	Adjusts factory calibration for actual temperature.
	⑥ 	Enter the level value for the 4 mA point.	Default value is "0".
	⑦ 	Enter the level value for the 20 mA point.	Default value equals the displacer length.
	⑧ 	Enter the damping factor.	A Damping factor (1-45 seconds) may be added to smooth a noisy display and/or output due to turbulence.
	⑨ 	Enter the value for error.	Select «3.6 mA», «22 mA» or hold last value «HOLD». In case of loop failure, error signal will follow the failing trend; meaning the unit will show 3.6 mA when the reviewed loop current by the device is found too low. The unit will show 22 mA in case the reviewed loop current is found too high.
		= Wet calibration procedure	

Screen	Action	Comment
⑩ Poll Adr xx	Enter HART ID number.	Select a HART poll address (0-15). Enter 0 for a single transmitter installation.
⑪ Trim SG xx.x	Enter SG value to adjust SG value reading.	Allows to compensate for a fixed deviation.
⑫ Trim 4 xxxx	Fine tune the 4 mA point. (Trim 0-20)	Attach a mA meter to the output. If the output does not equal 4.0 mA, adjust the value on the display to equal 4.00 mA.
⑬ Trim 20 xxxx	Fine tune the 20 mA point. (Trim 4-4095)	Attach a mA meter to the output. If the output does not equal 20.0 mA, adjust the value on the display to equal 20.00 mA.
⑭ Loop Tst xx.x mA	Enter a mA output value.	Set mA Output to any given value to perform loop test.
⑮ Capture 4.00 mA	The immersed displacer is fully immersed in liquid at the min. S.G. value = 4 mA point. Press Enter to enter manual setting mode. Press up arrow + Enter (simultaneously) to confirm 4 mA value.	Manual setting of 4 mA output signal. Displacer immersed in liquid with the min. S.G.
⑯ Capture 20.00 mA	The immersed displacer is fully immersed in liquid at the max. S.G. value = 20 mA point. Press Enter to enter manual setting mode. Press up arrow + Enter (simultaneously) to confirm 20 mA value. Note: in case the max. S.G. cannot be reached, adjust loop readout to current S.G. (see at right).	Liquid S.G. is ideally brought to match with 20 mA point. If this is not possible, bring S.G. to the highest possible value (should correspond with min 8 mA). Attach a mA meter and adjust the loop current via the keypad (down & up arrows) to match with the calculated mA value of the current S.G.
⑰ New Pass xxx	Enter new password.	Use arrows to select desired value. Values between 0 and 255.
⑱ Language	Select language.	Select «English», «Français», «Deutsch» or «Espagnol».
⑲ E3 ModHT Ver xx.xx	None, do not adjust.	Factory setting. «Ver» refers to software version.
⑳ DispFact (select)	Advanced diagnostics.	See page 15.

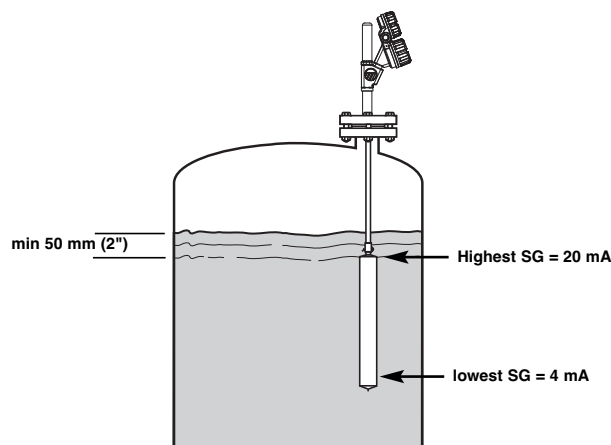

LEVEL MEASUREMENT: 100 % level cannot be reached

Calibrate 4 mA/0 % level

Bring level lower than displacer (free hanging) or to the lowest level.
 Press Enter = start calibration.
 Press Up + Enter = lock 4 mA value

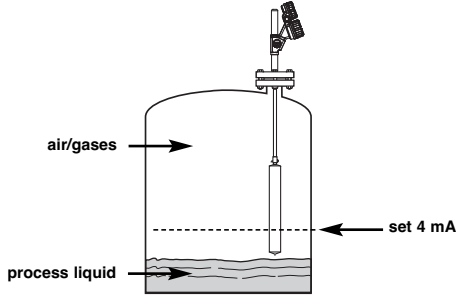

Calibrate 20 mA/100 % level:

Bring level to the highest possible position
 Attach a mA meter to the test points
 Adjust the loop current via Up and Down

Eg. 50 % level reads 10 mA. Toggle with the Up button, till the mA meter reads

$$(20 \text{ mA} - 4 \text{ mA}) \times 50 \% + 4 \text{ mA} = 12 \text{ mA}$$

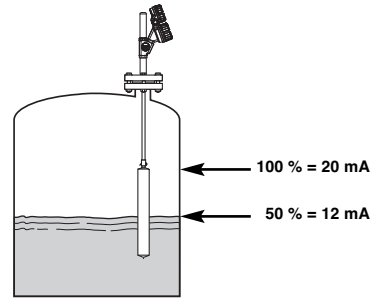

INTERFACE MEASUREMENT: using the process liquid

Important: Displacer must remain always immersed for min. 50 mm (2") in the upper liquid.

Calibrate 4 mA/0 % level

Bring interface at lowest level
 Press Enter = start calibration.
 Press Up + Enter = lock 4 mA value

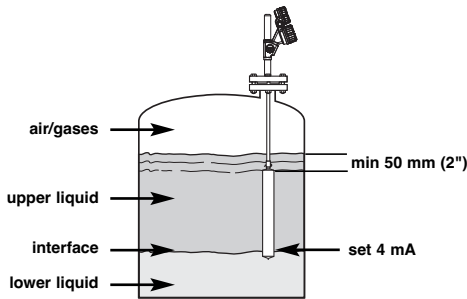

Calibrate 20 mA/100 % level:

Bring interface at highest level
 Press Enter = start calibration
 Press Up + Enter = lock 20 mA value

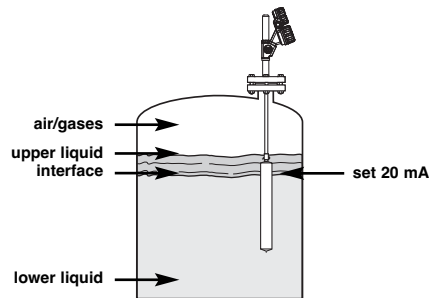

INTERFACE MEASUREMENT: using water for calibration

Lower liquid is water with S.G. = 1.0 kg/dm³
 Upper liquid with S.G. = 0.80 kg/dm³

NOTE: in case the liquid would be 0.78 kg/dm³, immerge the displacer only for 78% instead of 80% as per below example.

Calibrate 4 mA/0 % level

Immerge displacer for 80 % in water
 Press Enter = start calibration.
 Press Up + Enter = lock 4 mA value.

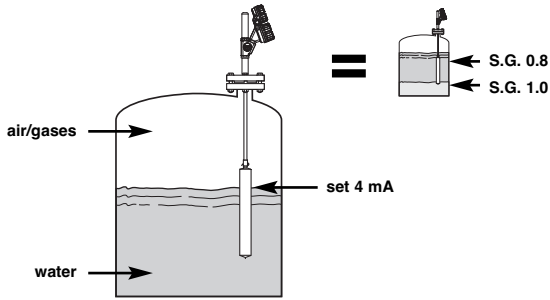

Calibrate 20 mA/100 % level:

Immerge displacer for 100 % in water
 Press Enter = start calibration
 Press Up + Enter = lock 20 mA value.

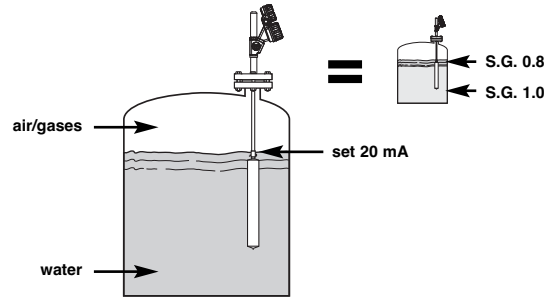

Lower liquid with S.G. = 1.2 kg/dm³
 Upper liquid with S.G. = 0.80 kg/dm³

Calibrate 4 mA/0 % level

Immerge displacer for 80 % in water
 Press Enter = start calibration.
 Press Up + Enter = lock 4 mA value.

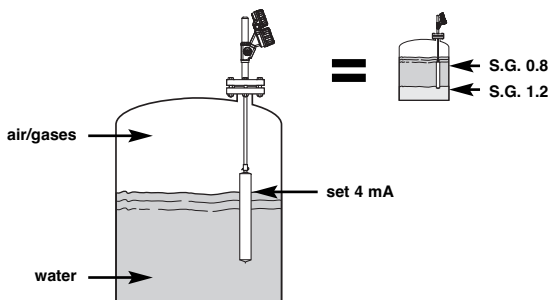

Calibrate 20 mA/100 % level:

Immerge displacer for 100 % in water
 Press Enter = start calibration
 Press Up and/or Down = untill loop signal corresponds with, in our example, **12 mA**

$$\text{Calculation: } \frac{100 \times (1 - \text{Upper S.G.})}{\text{Lower S.G.} - \text{Upper S.G.}} = \% \text{ Span}$$

$$\frac{100 \times (1 - 0,8)}{1,2 - 0,8} = 50 \%$$

$$[(20 \text{ mA} - 4 \text{ mA}) \times 50 \%] + 4 \text{ mA} = 12 \text{ mA}$$

Press Up + Enter = lock 20 mA value

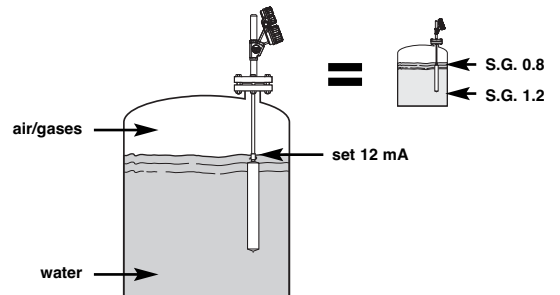

MENU: STEP BY STEP PROCEDURE: ADVANCED CONFIGURATION

Hidden diagnostic screens. Do not access without assistance or having followed advanced training.

Screen	Action	Comment
① DispFact Select	Review factory parameters	Select «YES» to reveal Factory parameters; «NO» to hide.
② History (current status)	Review Diagnostic messages.	A cumulative review of all diagnostic messages. Press the enter button twice to clear.
③ Run time xxxx.x h	Display mode.	Shows time in hours that unit is in operation since last power on.
④ History Reset	Diagnostic display.	Select «YES» to clear «History».
⑤ MeasType (select)	Factory set.	Level, lfcLevel or Density.
⑥ Model (select)	Factory set.	E31, E32, E33, E34, E35, E36.
⑦ SpringSG (select)	Factory set.	Model specific.
⑧ SprgRate x.x	Factory set.	Model specific.
⑨ SprgMat1	Factory set.	Model specific.
⑩ TempLmt xxx C	Factory set.	Model specific. Max process temperature for which unit is suitable.
⑪ Length xx.xx cm	Factory set.	Model specific. Length of measuring range.
⑫ Diameter x.xxx cm	Factory set.	Model specific. Outside diameter of displacer.
⑬ Weight xx.x kg	Factory set.	Model specific. Weight of displacer
⑭ Lower SG x.xx	Factory set.	Only for interface units.
⑮ Upper SG x.xx	Factory set.	Only for interface units.
⑯ CalSelct (select)	Select factory or user calibration.	Selects calibration parameters used to calculate the measured PV.
⑰ Factory Cal Menu	Depress enter to display the factory calibration sub-menu.	CalSelct = factory submenu on page 15
User Cal Menu	Depress enter to display the factory calibration sub-menu.	CalSelct = user submenu on page 15
⑱ AdjSnrLo	Diagnostic display.	
⑲ AdjSnrHi	Diagnostic display.	
⑳ Conv Fct xxxx	None, do not adjust.	Factory setting.
㉑ Scl Ofst xxx	None, do not adjust.	Factory setting.
㉒ LVDT% xx.xx %	Diagnostic display.	
㉓ Chan 0	Diagnostic display.	
㉔ Chan 1	Diagnostic display.	
㉕ NSP Value	Diagnostic display.	
㉖ ElecTemp xxx C	None, do not adjust.	Diagnostic display, shows current internal housing temperature recorded.
㉗ Max Temp xxx C	None, do not adjust.	Diagnostic display, shows maximum internal housing temperature recorded.
㉘ Min Temp xxx C	None, do not adjust.	Diagnostic display, shows minimum internal housing temperature recorded.

SUBMENU FACTORY OR USER

«CalSelct» allows to view either the factory settings «Factory» or the super user modified settings «User». Spare heads will be configured per factory default values and will be different from the super user modified settings. The super user settings overrule the factory settings, whereby the factory settings can at all times be referenced to, to allow efficient troubleshooting.

Screen	Action	Comment
① <input type="text" value="LVDT%
xx.xx %"/>	Diagnostic display.	
② <input type="text" value="Calib SG
xx.xx sg"/>	Factory set.	Factory calibration menu. Only used for units configured for liquid level applications.
③ <input type="text" value="DrySenr
xx.xx %"/>	Enter or capture sensor output for Dry Sensor.	Press up arrow + Enter (simultaneously) to capture current sensor output.
④ <input type="text" value="SnrCalLo
xx.xx %"/>	Enter or capture sensor output for Low Cal Point.	Press up arrow + Enter (simultaneously) to capture current sensor output.
⑤ <input type="text" value="LvlCalLo
xx.xx lu"/>	Enter level value corresponding to SnrCalLo.	
⑥ <input type="text" value="Set 4mA
xx.xx lu"/>	Enter the level value for 4 mA set point.	Specify level at 4 mA (User Cal menu only).
⑦ <input type="text" value="SnrCalHi
xx.xx %"/>	Enter or capture sensor output for High Cal Point.	Press up arrow + Enter (simultaneously) to capture current sensor output.
⑧ <input type="text" value="LvlCalHi
xx.xx lu"/>	Enter level value corresponding to SnrCalHi.	
⑨ <input type="text" value="Set 20mA
xx.xx lu"/>	Enter the level value for 20 mA set point.	Specify level at 20 mA (User Cal menu only).
⑩ <input type="text" value="Escape"/>	Depress enter key to exit calibration sub-menu; returns to factory menu.	

Diagnostics

USER CALIBRATION PROCEDURE

Use this procedure

- for matching new E3 electronics with older generation EZ Module levels
- when replacing spare parts: Electronic module, LVDT assembly, range spring, stem assembly or displacer
- for exchanging a complete electronics head on a E3 Model.

NOTE: This procedure should be performed at normal operating conditions.

Capturing the 4mA value

1. Move liquid level on displacer to desired low level point. Using keypad and LCD display, scroll down to DispFact.
2. Press \leftarrow to access data entry mode, then \downarrow until "Yes" is displayed and \leftarrow again. The factory menu is now accessible.
3. Scroll down to CalSelct.
4. Press \leftarrow , then \downarrow until "User" is displayed and \leftarrow again.
5. Press \downarrow to UserCalMenu and press \leftarrow to show the menu.
6. Scroll down to SnrCalLo.
7. Press \leftarrow , then \uparrow and \leftarrow simultaneously and \leftarrow again. The current liquid level has been captured as the low level point.
8. Scroll down to LvlCalLo. The default value is 0.00. If a different level value is desired at this point, press \leftarrow , use the \uparrow and \downarrow keys to choose the desired value and press \leftarrow again.

Capturing the 20mA value

9. Move the liquid level on displacer to the desired high level point. Scroll to SnrCalHi.
10. Press \leftarrow , then \uparrow and \leftarrow simultaneously and \leftarrow again. The current liquid level has been captured as the high level point.
11. Scroll down to LvlCalHi. The default value is the displacer length. If a different level value is desired at this point, press \leftarrow , use the \uparrow and \downarrow keys to choose the desired value and press \leftarrow again. The user calibration is complete.

NOTE: PACTware™ provides a user friendly way to remotely perform the identical procedure

For more details about the use of PACTware™ and FDT technology, refer to instruction manual 59-601

WHAT IS FDT, PACTware™ AND DTM

- FDT (Field Device Tool) is a new interface code that describes the standardization between frame programs (e.g., PACTware™) and DTMs (Device Type Manager).
- PACTware™ (Process Automation Configuration Tool) is a frame program. It is a device-independent software program that communicates with all approved DTMs.
- DTM (Device Type Manager) is a device-specific software driver designed to operate within a FDT compatible frame program such as PACTware™. It includes all special information needed to communicate with a specific device (e.g., Pulsar RX5). There are two basic categories of DTM's—Communication (HART, Fieldbus®, Profibus®, etc.) and Field Device (e.g. Pulsar RX5 Radar transmitter).

CONNECTIONS

The following diagram shows a typical hardware configuration. Observe all safety codes when attaching to instrument loops in hazardous areas or when measuring flammable media. Computers are not intrinsically safe devices.

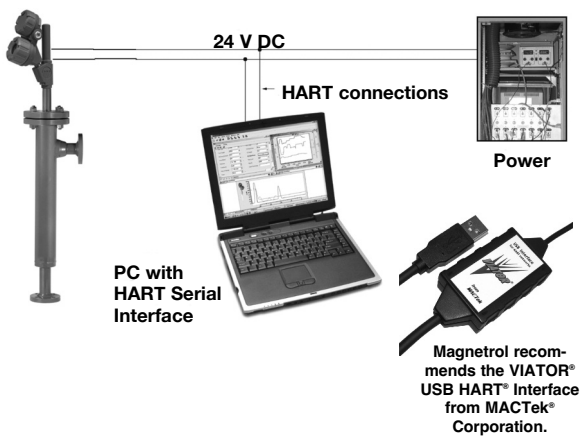

QUICK START

1. Start a project

Open Pactware and add the Hart modem key and then the Magnetrol instrument to your project.
 Select: «Device» – «add device» – select device (repeat for each device in your project)
Important: Make sure that the COM port settings for your Hart modem key are correct;

2. Connect the devices

Select in the left window the Magnetrol instrument.
 Select: «Device» – «connect» (both modem and Magnetrol instrument are getting connected)

3. Configure the instrument

Select: «Device» – «parameter» – «Online parameterization»
 Open «+ Main Menu» and select «+ Device set up» – «Calibration»
 Parameters can be changed in the window at right, via the drop down boxes. ENTER confirms the change online.

4. Manually calibrate the 4-20mA output

Select in «Calibration» - «Set point Calib» and Select «Capture values».
 A warning message appears to remove the loop from DCS.
 Set the 4mA (see MENU pages) «Capture 4mA»
 Set the 20mA or 20 mA by % (see MENU pages) «Capture 20mA», close the procedure by selecting «End».

5. Diagnostics

E3 Modulelevel offers the ability to monitor output and LVDT position.
 Select: «Device» – «parameter» – «Online parameterization»
 Open «+ Main Menu» and select «+ Device set up» – «Diagnostics»
 An overview is provided of all possible diagnostic values. A Print screen shot can, in case of field problems, be sent for factory assistance. This screen also provides a loop test function: 4mA, 20mA or any random mA test value. Close the loop procedure by selecting «End».

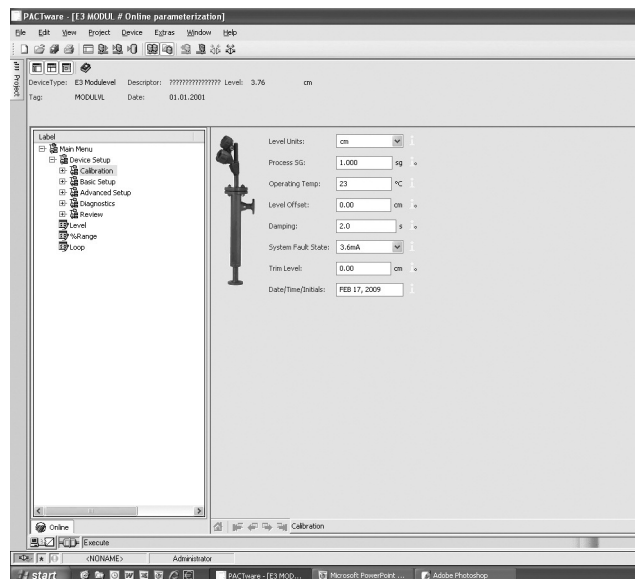

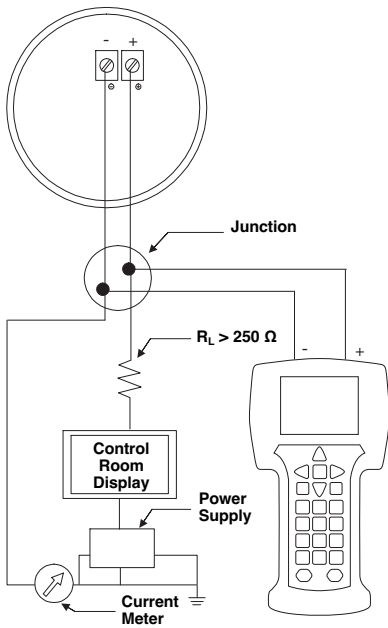

CONNECTIONS

- Connection of your Hart communicator:
- at power terminals (+) and (-) in wiring compartment
 - at first junction box between unit and control room.

IMPORTANT: The digital HART® communication is superimposed on the 4-20 mA loop and requires a min. load resistance of 250 Ω and a max load resistance of 450 Ω.

CHECK HART®

Before starting the HART® configuration procedure – check if your HART® communicator is equipped with the proper E3 Modulelevel Device Descriptors (DD's).

- I/O start up the communicator
- Select NO: go offline
- Select 4: utility
- Select 5: simulation
- Check manufacturer: Magnetrol

HCF Release Date	HART Version	Compatible with software
December 2007	Dev V1, DD V1	Version 1.0A through 1.0D
September 2011	Dev V2, DD V1	Version 1.1A and later

When the proper software version is not found, consult your local HART® Service Center to load the correct E3 Modulelevel DD's.

HART MENU

- I/O Start up the device
- 1 Enter Device Set Up «DEVICE SET UP»
Press one of the following alphanumeric keys (if no key is sensed after 5 s, the unit will automatically jump to RUN mode and alternatively show Level/% Output and Loop signal)
 - 1 for entering Calibration «CALIBRATION» (see next page for additional information)
 - 2 for entering Basic Set Up «BASIC SET UP» – general HART
 - 3 for Advanced Set Up «ADVANCED SET UP» (see next page for additional information)
 - 4 for entering Diagnostics «DIAGNOSTICS» (see next page for additional information)
 - 5 for entering Review «REVIEW» to review all settings.

CONFIGURATION USING HART®

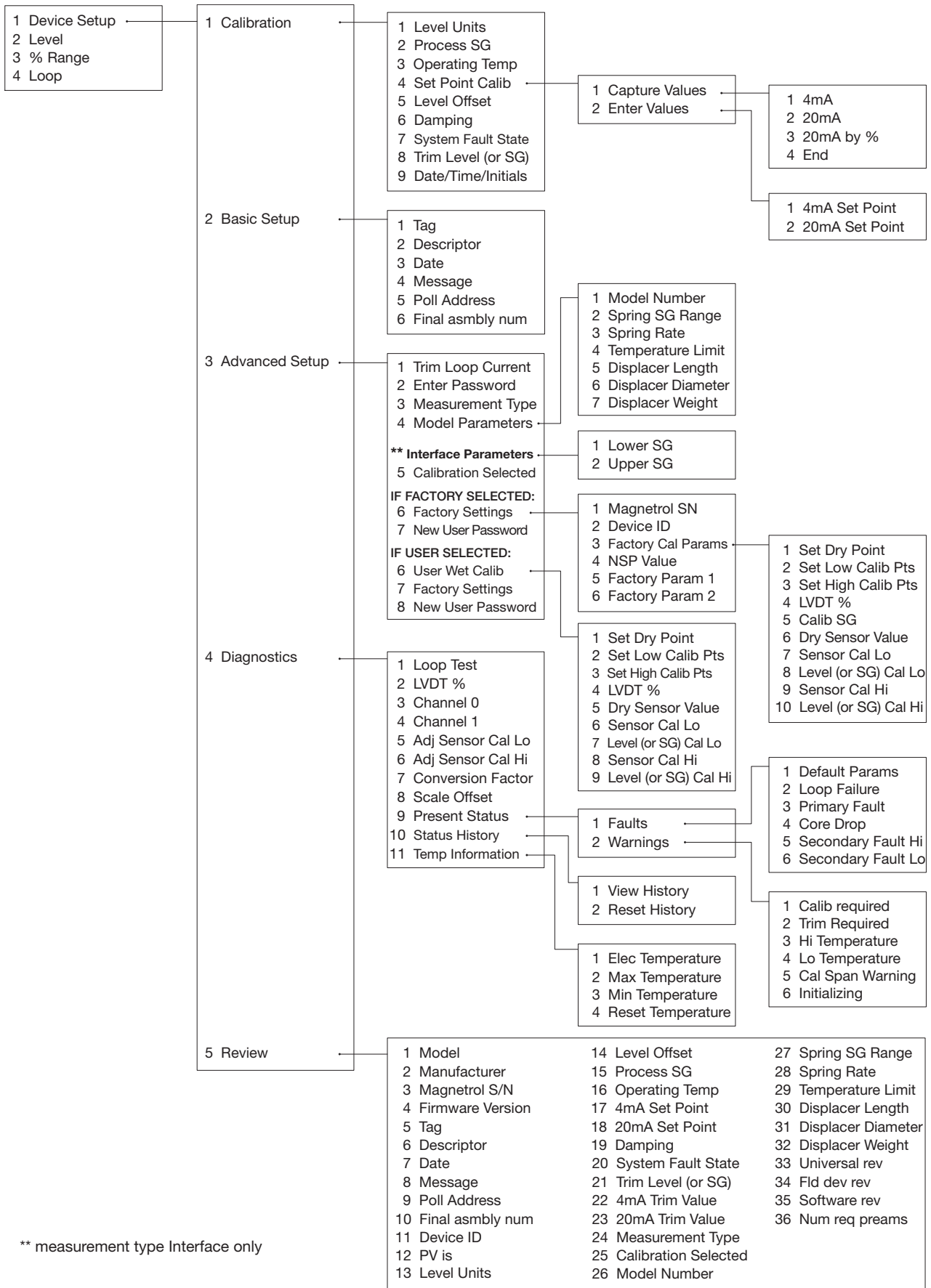

TROUBLESHOOTING SYSTEM PROBLEMS

Symptom	Problem	Solution
No loop current.	Power supply not turned on.	Turn on power.
	Insufficient source voltage.	E3 requires a minimum of 11 VDC at the wiring board. Verify supply voltage.
	Improperly wired or damaged wiring.	Check wiring and connections.
	Defective electronics.	Replace PC board assembly or wiring board as required.
LEVEL, % OUTPUT and LOOP values are all inaccurate.	Basic configuration data is questionable.	Verify Level Offset values. If using factory calibration, verify that Process SG and Operating Temperature values are accurate. Verify/confirm that Model Parameters are accurate. Confirm set points are as expected.
Transmitter does not track level.	Model incompatible with process liquid	Verify model in use is appropriate for process liquid SG.
	Possible damage to unit.	Check displacer, spring, stem and enclosing tube for damage. Replace all damaged parts.
	Possible material buildup	Check displacer, spring, stem, enclosing tube and displacer for buildup of process material. Clean any fouled parts.
	Displacer, spring or stem dragging on inside of chamber, e-tube.	Verify proper and level installation (within 3 degrees of plumb in all directions).
Level reading on display is correct, but loop value is stuck at 4 mA.	Invalid poll address.	Set poll address to 0 if not using multi-drop.
LEVEL, % OUTPUT and LOOP values fluctuate.	Liquid turbulence.	Increase damping until output stabilizes or install stilling well.
	Power supply unstable.	Repair or replace power supply.
	Electrical interference (RFI).	Consult factory for assistance.
HART device only: Handheld will only read Universal Commands	Most current Device Descriptors are not installed in handheld.	Contact local HART service center for the latest DDs.
Cannot set high level to 20 mA	Incorrect power supply.	Check power supply.
	Excessive loop resistance	Increase power supply voltage or decrease loop resistance (max 620 ohms @ 24 VDC).
Loop current less than 4 mA	Liquid level less than 0%.	No action required.
	Supply voltage out of limits at transmitter.	Adjust power supply or reduce loop resistance.
4 mA output does not match display	4 mA may need to be trimmed.	Use Trim 4 mA to adjust output to match display.
Loop current exceeds 20 mA	Liquid level greater than 100%.	No action required.
	Supply voltage out of limits at transmitter.	Adjust power supply or reduce loop resistance.
	Wired incorrectly.	Check power supply (+) and (-) for reverse wiring.
20 mA output does not match display	20 mA may need to be trimmed.	Use Trim 20 mA to adjust output to match display.
Output jumps quickly over wide range	Bent stem impeding smooth core movement	Review Status History for Surge event. Inspect stem and replace if damaged.
Non-linear output.	Excessive loop resistance.	Increase power supply voltage or decrease loop resistance.
	Displacer hanging up.	Verify proper and level installation (within 3 degrees of plumb in all directions.)
	Bent stem.	Check stem. Replace if damaged.
	Possible material buildup	Check displacer, spring, stem, enclosing tube and displacer for buildup of process material. Clean any fouled parts.

MAINTENANCE

INFORMATION MESSAGES

The lowest in the hierarchy of diagnostic conditions provides operational factors that are not critical to measurement. Further error information can be obtained by viewing the status history in the factory menu.

Display Message	Description	Solution
OK	Absence of any warning or fault	No action required.
System Warning	Unexpected system events	No action required unless warning persists
Surge	Readings from the LVDT secondary windings are changing more rapidly than expected.	Rate of level change is greater than expected. Check for possible process surge or bent stem.

WARNING MESSAGES

A warning message identifies the status of the instrument. A warning message does not necessarily require immediate action but may require close attention and/or follow up. The warning message will be displayed on the unit and/or selected on the PACT_{ware}TM screen while the output signal will remain normal.

Display Message	Description	Solution
Initial	Initializing, PV held at 4 mA set point while unit powers up. Should be transient.	No action required.
Cal Span	Span between Sensor Calibration Hi and Lo values is less than minimum span.	Recalibrate or reconfigure unit with longer span
Lo Temp	Present temperature measured in electronics compartment is below -40 °C (-40 °F).	<ol style="list-style-type: none">1. Transmitter may need to be moved to ensure ambient temperature is within specification2. Change to remote mount transmitter3. Controlled external heat may be required to ensure that temperature inside housing is within specification
Hi Temp	Present temperature measured in electronics compartment is above +80 °C (+176 °F).	<ol style="list-style-type: none">1. Transmitter may need to be moved to ensure ambient temperature is within specification2. Change to remote mount transmitter3. Controlled external cooling may be required to ensure that temperature inside housing is within specification
TrimReqd	Loop trim values are defaults; loop output may be inaccurate.	Perform Loop Trim operation.
Cal Req'd	Default calibration parameters in use, level reading inaccurate.	Consult factory.

MAINTENANCE

ERROR MESSAGES

An error message identifies a possible instrument failure and requires an action. The error message will be displayed on the unit and/or selected on the Pactware screen while the output signal will shift to the selected error output (3.6mA, 22mA or HOLD).

Display Message	Description	Solution
SecFltHi	<ul style="list-style-type: none">A/D readings from LVDT secondary windings are above expected range.Bad LVDT wiring connection.	<ul style="list-style-type: none">Check for missing displacer.Check LVDT winding resistance.
SecFltLo*	<ul style="list-style-type: none">A/D readings from LVDT secondary windings are below expected range.Bad LVDT wiring connection.	<ul style="list-style-type: none">Check for broken spring or leaking displacer.Check LVDT winding resistance.
CoreDrop	<ul style="list-style-type: none">Core too far out.Bad LVDT wiring connection.	<ul style="list-style-type: none">Check for lost or damaged LVDT core.Check LVDT winding resistance.
PriFault	LVDT Primary circuit open condition.	Check LVDT winding resistance. Replace LVDT if values are out of range
LoopFail	Loop current differs from commanded value by more than 1.00 mA.	Consult factory.
DfltParm	Non-volatile parameters have been defaulted.	Consult factory.

* Can occur when unit is designed for interface and no liquid is on the displacer.

EFFECTS OF EACH DIAGNOSTIC MESSAGE

	Loop Output	Status Message	Status History
Fault	3.6/22/HOLD	Yes	Yes
Warning	No Effect	Yes	Yes
Information	No Effect	No	Yes

REMOVAL OF EZ TRANSMITTER HEAD

CAUTION: BENDING THE ENCLOSING TUBE WILL PERMANENTLY DAMAGE THE UNIT.

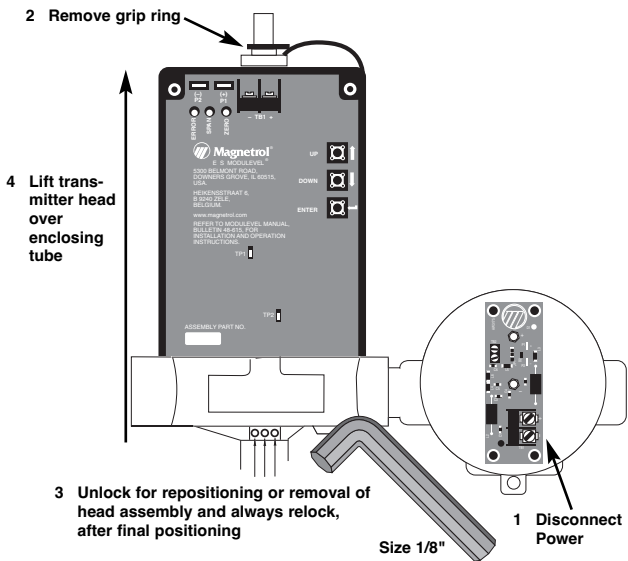

REPLACING WITH E3 TRANSMITTER HEAD

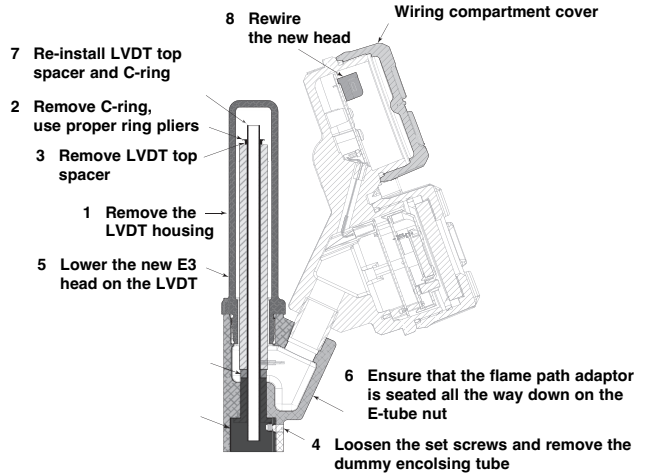

NOTE:
Remove transport enclosing tube before mounting
For calibration, use only the calibration procedure, page 15.

REPLACING LINEAR VARIABLE DIFFERENTIAL TRANSFORMER (LVDT)

CAUTION: REMOVE POWER FIRST.

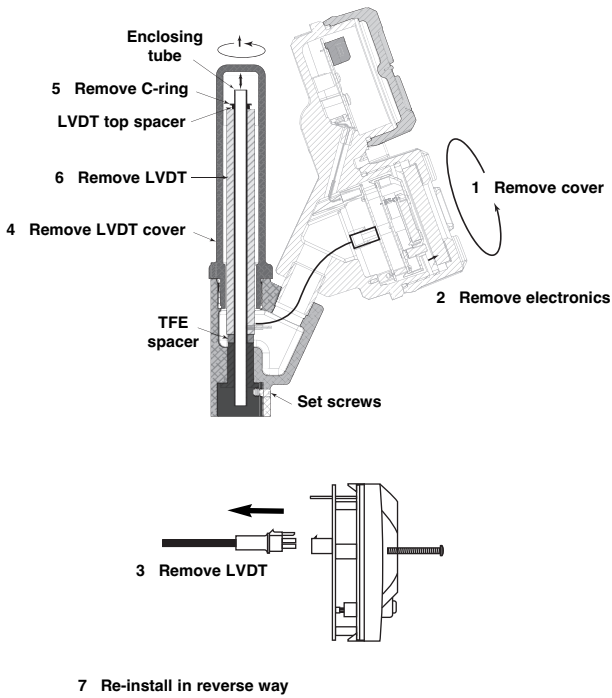

CHEKING THE LVDT WINDING RESISTANCE

- Using a multimeter, check primary winding. Pins 1 and 4 should have approximately 75 to 105 Ω .
- Secondary winding (pins 2 and 5 or 3 and 6) should have approximately 70 to 100 Ω . If not in this range, replace the LVDT.

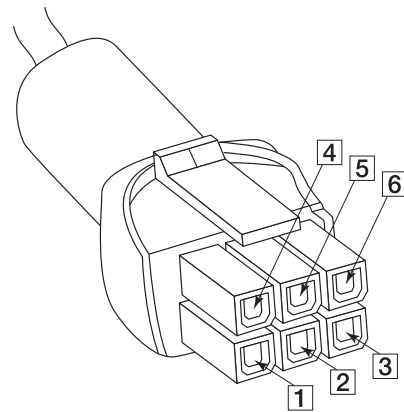

REPLACEMENT PARTS

All replacement parts are for standard models only. Consult factory for replacement parts on modified units (model number preceded by an X).

EXPEDITE SHIP PLAN (ESP)

Several parts are available for quick shipment, within max. 1 week after factory receipt of purchase order, through the Expedite Ship Plan (ESP).

Parts covered by ESP service are conveniently grey coded in the selection tables.

Transmitter head

Integral

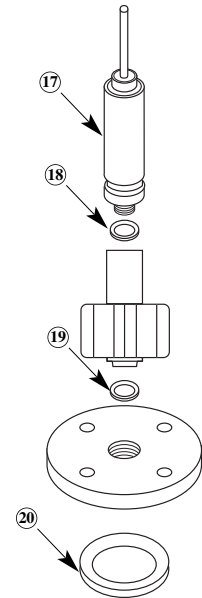
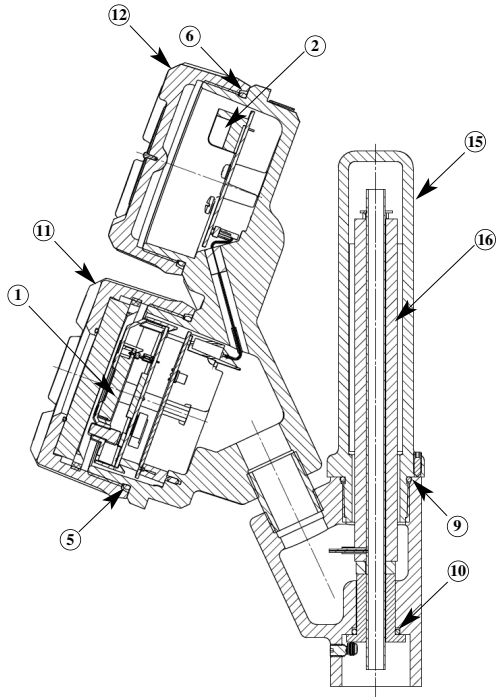

Transmitter head

Remote

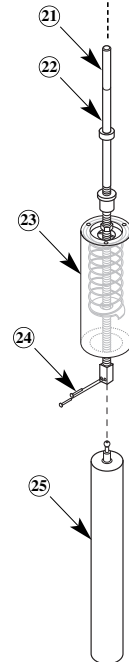
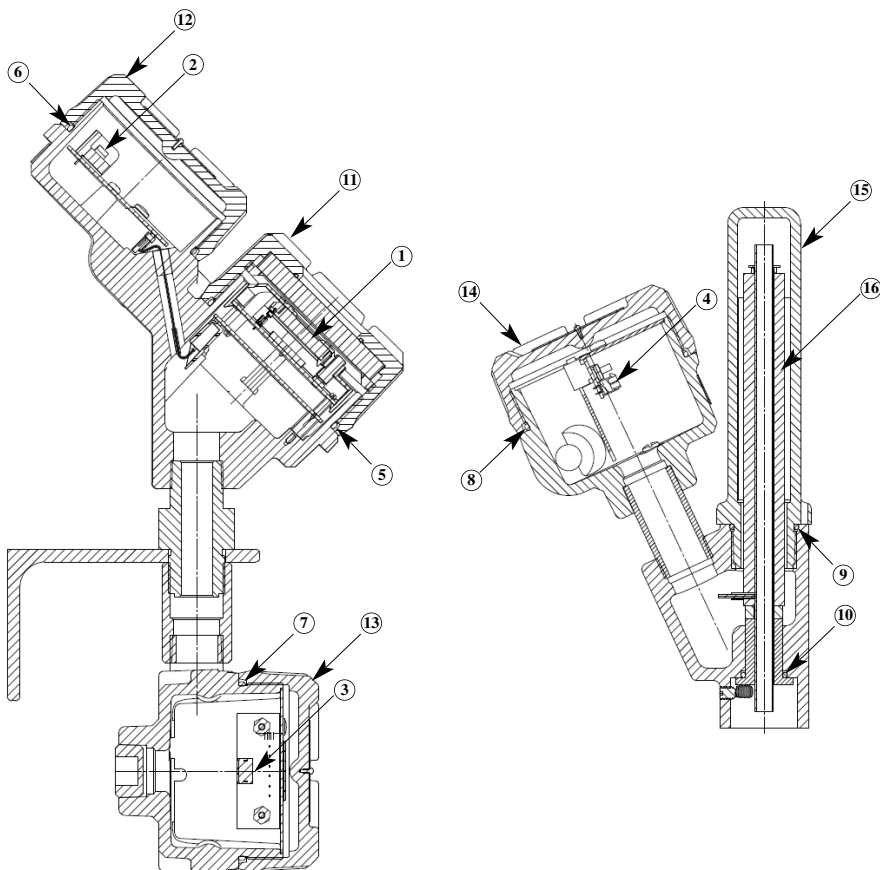

REPLACEMENT PARTS

Partn°:

--	--	--	--	--	--	--	--	--	--

Serial n°:

--	--	--	--	--	--	--	--	--	--

Digit in partn°:

X	1	2	3	4	5	6	7	8	9	10
---	---	---	---	---	---	---	---	---	---	----

See nameplate, always provide complete partn° and serial n° when ordering spares.

↳ X = if there are any deviations from a standard partn°

Caution: Field replacement of one of the following parts requires a user calibration of the repaired unit: items 1, 16, 22, 23, 25.

Consult factory to obtain the correct replacement part numbers for items not listed in the tables below.

(1) Electronic module		
Digit 8	Digit 9	Replacement part
H	1, 2, 3	Z31-2844-001
	8	Z31-2844-002
F	1, 2, 3	Z31-2845-001
	8	Z31-2845-002

(2) Wiring PC board		
Digit 8	Digit 10	Replacement part
H	all	Z30-9151-001
F	1, 2, 3, 4, E, F, G, H	Z30-9151-003
	5, 6, 7, 8, A, B, C, D, J, K, L, M	Z30-9151-004

Housing assembly				
Replacement part				
	Digit			
		8	9	10
		↓	↓	↓
Z39-4101-				

(3) Remote PC board	
Digit 9	Replacement part
1, 2, 3	not applicable
8	030-3609-001

(4) Remote PC board	
Digit 9	Replacement part
1, 2, 3	not applicable
8	030-3609-001

Housing "O"-ring kit (contains items 5, 6, 9 & 10)	
Replacement part	
089-6562-002	

(7) "O"-ring	
Digit 9	Replacement part
1, 2, 3	not applicable
8	012-2201-237

(8) "O"-ring	
Digit 9	Replacement part
1, 2, 3	not applicable
8	012-2201-237

(11) Housing cover	
Digit 10	Replacement part
1, 2	036-4413-001
3, 4, 7, 8, C, D, L, M	036-4413-002
5, 6, A, B, J, K	036-4413-005
E, F	036-4410-003
G, H	036-4413-012

(12) Housing cover (13) Housing cover (14) Housing cover			
Digit 10	Replacement part	Replacement part	Replacement part
1, 2, 5, 6, A, B, E, F, J, K	004-9225-002	004-9225-002	004-9225-002
3, 4, 7, 8, C, D, G, H, L, M	004-9225-003	004-9225-003	004-9225-003

(16) LVDT assembly kit	
Digit 9	Replacement part
1	089-7827-007
2	089-7827-008
3	089-7827-009
8	089-7827-010 (*)

(15) LVDT cover		
Digit 9	Digit 10	Replacement part
1, 2, 3	1, 2, 5, 6, A, B, E, F, J, K	089-7837-001
	3, 4, 7, 8, C, D, G, H, L, M	089-7837-002 (*)
8	all	089-7837-003 (*)

(*) includes "O"-ring (item 9)

(*) includes core (item 21)

	Replacement part
(9) LVDT cover "O"-ring	012-2222-123
(18) Enclosing tube gasket	012-1204-001
(24) Cotter pin (ordering qty: 2)	010-5203-001

(17) Enclosing tube			
Digit 9	Digit 6	Digit 10	Replacement part
1, 2, 3	3, 4, 5, A, C, D, E, F, K, L	all except E, F, G, H	032-6401-007
		E, F, G, H	032-6401-010
	G, H, M, N	all	032-6401-010
8	all	all	032-6401-014

(19) Temperature extension gasket	
Digit 4	Replacement part
J, K, L	not applicable
all except J, K, L	012-1204-001

REPLACEMENT PARTS

(20) Chamber gasket / ring joint			
Note: not applicable if digit 3 = 1, 2			
Digit 6	Digit 3	Digit 9	Replacement part
3, A	3, 4, 5, 6	1	012-1301-017
		2, 3, 8	012-1204-031
4, C	3, 4, 5, 6	1	012-1301-018
		2, 3, 8	012-1204-021
5, D, E, K	3, 4, 5, 6	all	012-1204-021
L	3, 5	all	012-1904-002
	4, 6	all	012-1906-002
F, G, M	3, 5	all	012-1904-003
	4, 6	all	012-1906-003
H, N	3, 5	all	012-1904-011
	4, 6	all	012-1906-011

(22) Stem assembly			
Digit 9	Digit 4	Digit 6	Replacement part
1, 2, 3	A	3, 4, 5, A, C, D, E, K	089-5565-004 (*)
	B	3, 4, 5, A, C, D, E, K	089-5565-003 (*)
		F, G, L, M	089-5565-004 (*)
		H, N	089-5565-010 (*)
	C	3, 4, 5, A, C, D, E, K	089-5565-003 (*)
	D	3, 4, 5, A, C, D, E, K	089-5565-008 (*)
	E	3, 4, 5, A, C, D, E, K	089-5565-007 (*)
		F, G, L, M	089-5565-008 (*)
		H, N	089-5565-012 (*)
	F	3, 4, 5, A, C, D, E, K	089-5565-007 (*)
	J	3, 4, 5, A, C, D, E, K	089-5565-002 (*)
	K	3, 4, 5, A, C, D, E, K	089-5565-001 (*)
		F, G, L, M	089-5565-002 (*)
		H, N	089-5565-009 (*)
	L	3, 4, 5, A, C, D, E, K	089-5565-001 (*)
	M	3, 4, 5, A, C, D, E, K	089-5565-006 (*)
N	3, 4, 5, A, C, D, E, K	089-5565-005 (*)	
	F, G, L, M	089-5565-006 (*)	
	H, N	089-5565-011 (*)	
P	3, 4, 5, A, C, D, E, K	089-5565-005 (*)	
8	E	3, 4, 5, A, C, D, E, K	032-5863-008
		F, G, L, M	032-5863-013
		H, N	032-5863-015
	N	3, 4, 5, A, C, D, E, K	032-5863-006
		F, G, L, M	032-5863-007
		H, N	032-5863-014

(*) includes core (item 21)

(21) LVDT core	
Digit 9	Replacement part
1, 2, 3	refer to item 22
8	refer to item 16

(23) Spring assembly kit			
(includes screws and lockwashers)			
Digit 9	Digit 6	Digit 4	Replacement part
1	3, 4, 5, A, C, D, E, K	A, J, M	089-5340-002
		B, K, N	089-5340-005
		C, L, P	089-5340-008
		D	089-5340-003
		E	089-5340-006
		F	089-5340-009
	F, G, H, L, M, N	B, E, K, N	089-5340-010
2	3, 4, 5, A, C, D, E, K	B, N	089-5340-005
	F, G, H, L, M, N	B, N	089-5340-010
3	3, 4, 5, A, C, D, E, K	E, N	089-5340-006
		M	089-5340-003
		P	089-5340-009
		E, N	089-5340-010
8	all	E, N	089-5340-011

(25) Displacer kit				
(includes 2 pieces of item 24)				
Digit 9	Digit 6	Digit 4	Digit 7	Replacement part
1, 2, 3	3, 4, 5, A, C, D, E, K	A, B, D, E, J, K, M, N	A	089-6125-001
			B	089-6125-002
			C	089-6125-003
			D	089-6125-004
			E	089-6125-005
			F	089-6125-006
			G	089-6125-007
			H	089-6125-008
			I	089-6125-009
	F, G, H, L, M, N	B, E, K, N	A	089-6126-001
			B	089-6126-002
			C	089-6126-003
			D	089-6126-004
			E	089-6126-005
			F	089-6126-006
			G	089-6126-007
			H	089-6126-008
			I	089-6126-009
8	all	E, N	A	089-6125-010
			B	089-6125-011
			C	089-6125-012
			D	089-6125-013
			E, F, G, H, I	consult factory
			E, F, G, H, I	consult factory

TRANSMITTER SPECIFICATIONS

FUNCTIONAL/PHYSICAL

Description	Specification	
Power (at terminals)	Weatherproof / Intrinsically Safe: 11 to 28,4 V DC (ATEX/IEC) - 28,6 V DC (FM) ATEX/IEC flameproof enclosure 11 to 36 V DC (ATEX/IEC-FM) FOUNDATION Fieldbus™ (FISCO Intrinsically Safe): 9 to 17,5 V DC FOUNDATION Fieldbus™ (Explosion proof): 9 to 32 V DC	
Signal Output	4-20 mA with HART®, 3,8 mA to 20,5 mA useable (meets NAMUR NE 43), FOUNDATION Fieldbus™ H1 (ITK Ver. 5)	
Span	from 356 mm up to 3048 mm (14" up to 120") - others at request	
Resolution	Analog: 0,01 mA Display: 0,1 cm (inch)	
Loop Resistance	620 Ω @ 20,5 mA - 24 V DC	
Damping	Adjustable 0-45 s	
Diagnostic Alarm	Adjustable 3,6 mA, 22 mA, HOLD	
User Interface	HART® communicator, AMS® or PACTware®, FOUNDATION Fieldbus™ and 3-button keypad	
Display	2-line x 8-character LCD	
Menu Language	English/Spanish/French/German (FOUNDATION Fieldbus™: English)	
Housing Material	IP 66/Aluminium A356T6 (< 0.20 % copper) or stainless steel	
Approvals	ATEX/IEC II 1 G Ex ia IIC T4, intrinsically safe ATEX/IEC II 1 G Ex ia IIC T4, FISCO – intrinsically safe ATEX/IEC II 1 / 2 G Ex d IIC T6, flameproof enclosure FM, Intrinsically Safe (FISCO) and explosion proof FOUNDATION Fieldbus™ units are FISCO (intrinsically safe) and ATEX/IEC – FM/CSA explosion proof approved LRS – Lloyds Register of Shipping (marine applications) RosTEch/FSTS – Russian Authorisation Standards	
SIL ^① (Safety Integrity Level)	Functional safety to SIL 2 as 1oo1 in accordance to 61508 – SFF of 92,3 % – full FMEDA report and declaration sheet available at request	
Electrical Data	U _i = 28,4 V, I _i = 94 mA, P _i = 0,67 W - ATEX/IEC U _i = 28,6 V, I _i = 140 mA, P _i = 1 W - FM U _i = 17,5 V, I _i = 380 mA, P _i = 5,32 W (FOUNDATION Fieldbus)	
Equivalent Data	C _i = 2,2 nF, L _i = 3 μH - ATEX/IEC C _i = 5,5 nF, L _i = 9 μH - FM C _i = 0,71 nF, L _i = 3 μH (FOUNDATION Fieldbus™)	
Shock/Vibration Class ^②	ANSI/ISA-S71.03 SA1 (Shock), ANSI/ISA-S71.03 VC2 (Vibration)	
Net and Gross Weight	Cast aluminium	3 kg (7 lbs) – amplifier only
	Stainless steel	8 kg (17 lbs) – amplifier only
Overall Dimensions	H 306 mm (12.05") x W 112 mm (4.41") x D 192 mm (7.56")	
FOUNDATION Fieldbus™ specifica- tions	ITK Version	5.0
	H1 Device Class	Link Master (LAS) – selectable ON/OFF
	H1 Profile Class	31PS, 32L
	Function Blocks	1 x AI and 1 x PID, 1 x RB, 1 x TB
	Quiescent current draw	17 mA
	Execution time	AI: 15 ms, PID: 40 ms
CFF files	Downloads available from Host system supplier or www.fieldbus.org	

^① Not applicable for FOUNDATION Fieldbus™ units.

^② With aluminium housing only. Does not apply to models with stainless steel housing.

TRANSMITTER SPECIFICATIONS

PERFORMANCE

Description		Specification
Linearity	Level	± 0,50 % of full span
	Interface/Density	± 0,70 % of full span
Repeatability	Level	± 0,05 % of full span
	Interface/Density	± 0,10 % of full span
Hysteresis		± 0,05 % of full span
Response Time		< 1 second
Warm-up Time		< 5 seconds
Ambient Temp.		-40 °C to +80 °C (-40 °F to +175 °F) – electronics temperature range -20 °C to +70 °C (-5 °F to +160 °F) – LCD temperature range -40 °C to +70 °C (-40 °F to +160 °F) – for Ex ia and Ex d units
Storage temperature		-40 °C to +85 °C (-40 °F to +185 °F)
Ambient Temp. Effect		Max zero shift is 0,03 % / °C (0,017 % / °F)
Process Temp.	Max	+425 °C (+800 °F) for steam / + 450 °C (+850 °F) for non steam
	Min	-30 °C (-20 °F) for carbon steel models / -196 °C (-320 °F) for stainless steel models
Max Process Pressure		355 bar @ +40 °C (5150 psi @ +100 °F).
Density Range		from 0,23 kg/dm ³ up to 2,20 kg/dm ³
Humidity		0-99 %, non-condensing
Electromagnetic Compatibility		Meets CE requirements (EN-61326: 1997 + A1 + A2)

MECHANICAL SPECIFICATIONS

Description		Specification
Cage materials		carbon steel or 316/316L (1.4401/1.4404) (other materials at request)
Wetted parts	Spring	Inconel® (other materials at request)
	Displacer	316/316L (1.4401/1.4404) or 316 (1.4401)
Process Connection		Threaded: 1 1/2" NPT-F or 2" NPT-F or 1 1/2" Socket Weld or 2" Socket Weld Flanged: Various ANSI or EN/DIN flanges
Displacer lengths		From 356 mm (14") up to 3048 mm (120") - other lengths at request

DIMENSIONS in mm (inches)

Transmitter Head

Integral

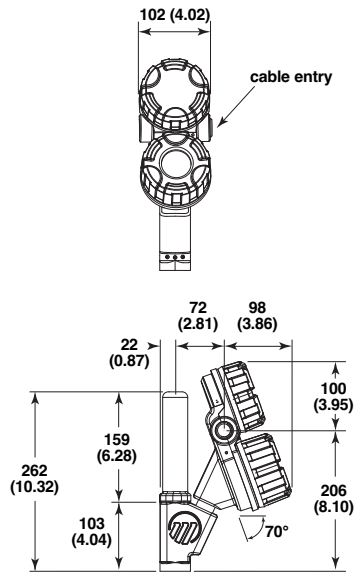

Remote

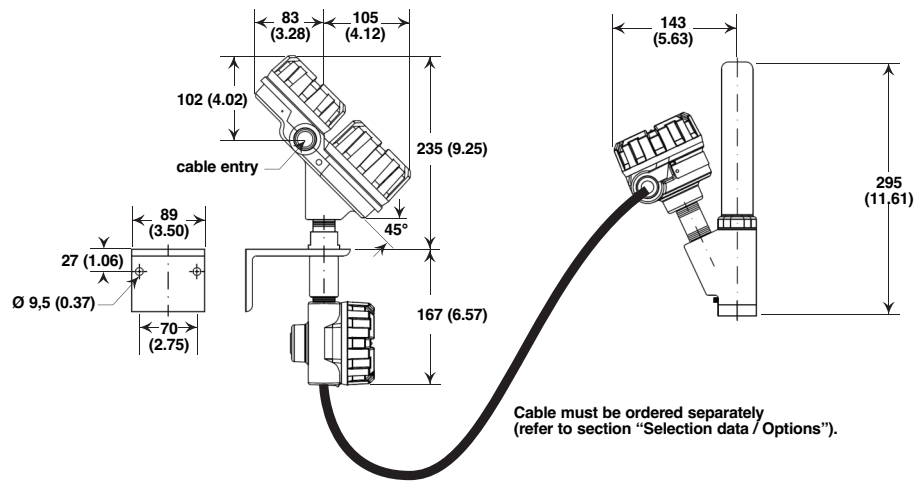

**Top Mounted
E31/E32 - J/K/L**

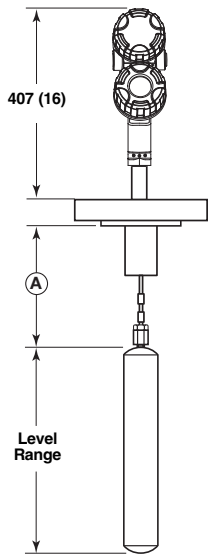

**Side/bottom cage
E33/E34 - J/K/L**

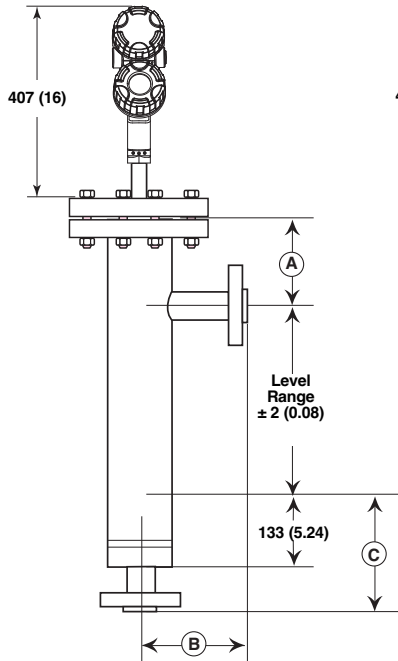

**Side/bottom cage
E33/E34 - J/K/L**

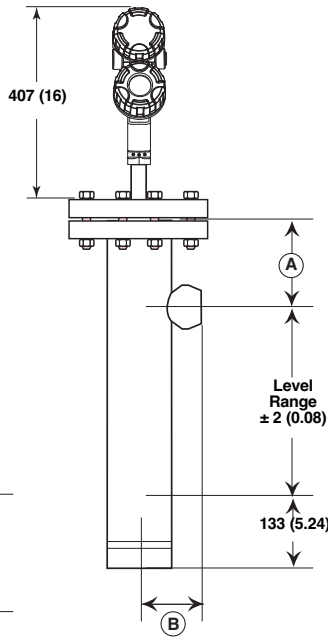

**Side/side cage
E35/E36 - J/K/L**

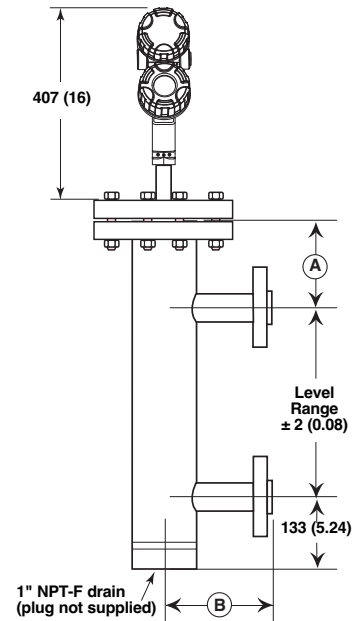

Temperature extensions

Integral

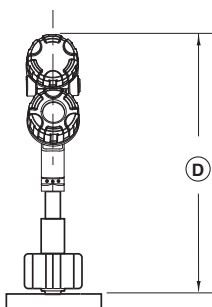

Digit 4	Dim. D
A, B, C	508 (20)
M, N, P	610 (24)
D, E, F	712 (28)

Remote

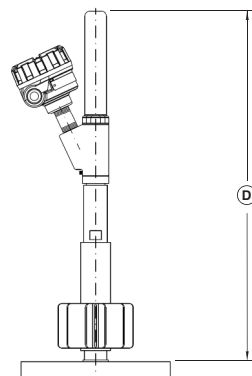

Digit 4	Dim. D
N	600 (23.6)
E	701 (27.6)

DIMENSIONS in mm (inches)

Dimension A for all models

Cage rating	SG range	4 th digit	9 th digit	Dimension A
150 / 300 / 600 lbs PN 16 .. PN 100	0.23 - 0.54	J/A/M/D	1/2/3	236 (9.29)
	0.55 - 1.09	K/B/N/E		186 (7.32)
	1.10 - 2.20	L/C/P/F		186 (7.32)
900 / 1500 lbs PN 160 / PN 250	0.55 - 1.09	K/B/N/E	1/2/3	245 (9.65)
2500 lbs PN 320				320 (12.60)
150 / 300 / 600 lbs PN 16 .. PN 100	0.55 - 1.09	N/E	8	236 (9.29)
900 / 1500 lbs PN 160 / PN 250				245 (9.65)
2500 lbs PN 320				320 (12.60)

Dimensions B and C for external cage models (E33/E34/E35/E36)

Flanged process connections				
Flange size	Flange rating	Connection type	Dimensions	
			B	C
1 1/2"	150 / 300 / 600 lbs	Slip on - ANSI RF	180 (7.09)	268 (10.55)
	600 lbs	Weldneck - ANSI RJ	180 (7.09)	268 (10.55)
	900 lbs	Weldneck - ANSI RJ	195 (7.68)	281 (11.06)
	1500 lbs	Weldneck - ANSI RJ	186 (7.32)	281 (11.06)
	2500 lbs	Weldneck - ANSI RJ	229 (9.02)	313 (12.32)
2"	150 / 300 / 600 lbs	Slip on - ANSI RF	185 (7.28)	273 (10.75)
	600 lbs	Weldneck - ANSI RJ	185 (7.28)	273 (10.75)
	900 lbs	Weldneck - ANSI RJ	215 (8.46)	302 (11.89)
	1500 lbs	Weldneck - ANSI RJ	212 (8.35)	302 (11.89)
	2500 lbs	Weldneck - ANSI RJ	250 (9.84)	329 (12.95)
DN 40	PN 16 / PN 25 / PN 40	EN 1092-1 Type B1	180 (7.09)	268 (10.55)
	PN 63 / PN 100	EN 1092-1 Type B2	200 (7.87)	288 (11.34)
	PN 160	EN 1092-1 Type B2	200 (7.87)	consult factory
	PN 250	EN 1092-1 Type B2	consult factory	consult factory
	PN 320	EN 1092-1 Type B2	consult factory	consult factory
DN 50	PN 16	EN 1092-1 Type B1	185 (7.28)	273 (10.75)
	PN 25 / 40	EN 1092-1 Type B1	188 (7.40)	276 (10.87)
	PN 63	EN 1092-1 Type B2	202 (7.95)	293 (11.54)
	PN 100	EN 1092-1 Type B2	208 (8.19)	299 (11.77)
	PN 160	EN 1092-1 Type B2	215 (8.46)	consult factory
	PN 250	EN 1092-1 Type B2	consult factory	consult factory
	PN 320	EN 1092-1 Type B2	consult factory	consult factory

Threaded / Socket weld process connections				
Size	Cage rating	Connection type	Dimensions	
			B	C
1 1/2"	150 / 300 / 600 / 900 lbs	NPT/SW	81 (3.19)	Not Applicable
	1500 lbs	NPT/SW	89 (3.50)	
	2500 lbs	NPT/SW	102 (4.02)	
2"	150 / 300 / 600 / 900 lbs	NPT/SW	84 (3.31)	
	1500 lbs	NPT/SW	98 (3.86)	
	2500 lbs	NPT/SW	111 (4.37)	

MODEL IDENTIFICATION

A complete measuring system consists of:

1. One order code for a complete E3 Modulelevel® transmitter.
2. Options:
 - Adjustable displacer hanger for top mounted units, cable length 2,5 m (8'). Order code **032-3110-004** – required when distance between the top of the displacer and the flange face is > dimension **A** (see section Dimensions) + 60 mm (2.36").
 - Free of charge: E3 Modulelevel DTM (PACT_{ware}™) can be downloaded from www.magnetrol.com.
 - Connecting cable used with remote mount electronics (6-wire cable/shielded, not suitable for ATEX/IEC flameproof enclosure). Consult factory for connecting cable suitable for ATEX/IEC flameproof enclosure.

0 0 1 - 0 2 3	From 1 m (3,28 ft) min. to 23 m (75,46 ft) max. Specify in increments of 1 m (3,28 ft)
---------------	---

1 3 7 — 3 2 2 7 —

complete order code for connecting cable

MODEL IDENTIFICATION – NON STEAM applications (max 600 lbs)

BASIC MODEL NUMBER

Carbon steel models

E 3 1	top mounted E3 Module level
E 3 3	E3 Module level with side/bottom cage
E 3 5	E3 Module level with side/side cage

Stainless steel models

E 3 2	top mounted E3 Module level
E 3 4	E3 Module level with side/bottom cage
E 3 6	E3 Module level with side/side cage

SPECIFIC GRAVITY AND PROCESS TEMPERATURE (consult factory for interface applications)
Match temperature extensions with max. process temperature (digit 9)

150 °C	200 °C	230 °C	290 °C	315 °C	400 °C	450 °C	max. temp. / S.G.
J	A	M	D	M	–	–	0.23 - 0.54 specific gravity
K	B	N	E	N	N	E	0.55 - 1.09 specific gravity
L	C	P	F	P	–	–	1.10 - 2.20 specific gravity

PROCESS CONNECTION

For top mounted connection type

E31/E32 - ANSI Flange rating					E31/E32 - EN 1092-1 (DIN) Flange rating				
150 lbs RF	300 lbs RF	600 lbs		Size	PN 16 Type B1	PN 25/40 Type B1	PN 63 Type B2	PN 100 Type B2	Size
		RF	RJ						
G3	G4	G5	GK	3"	EA	EC	ED	EE	DN 80
H3	H4	H5	HK	4"	FA	FC	FD	FE	DN 100
K3	K4	K5	KK	6"	GA	GC	GD	GE	DN 150

For external cage models

E33 ... E36 - ANSI Flange/Cage rating					E33 ... E36 - EN 1092-1 (DIN) Flange rating				
150 lbs RF	300 lbs RF	600 lbs		Size	PN 16 Type B1	PN 25/40 Type B1	PN 63 Type B2	PN 100 Type B2	Size
		RF	RJ						
P3	P4	P5	PK	1 1/2" flanged	CA	CC	CD	CE	DN 40 flanged
Q3	Q4	Q5	QK	2" flanged					
A3	A4	A5		1 1/2" NPT-F					
E3	E4	E5		2" NPT-F	DA	DC	DD	DE	DN 50 flanged
R3	R4	R5		1 1/2" S.W.					
F3	F4	F5		2" S.W.					

LEVEL RANGE

356	813	1219	1524	1829	2134	2438	2743	3048	mm
14	32	48	60	72	84	96	108	120	inches
A	B	C	D	E	F	G	H	I	code

TRANSMITTER ELECTRONICS

OUTPUT/COMMUNICATION

H	4-20 mA with Hart® communication incl. display / 3 button keypad
F	FOUNDATION Fieldbus communication incl. display / 3 button keypad

MAX PROCESS TEMPERATURE

Match max. process temperature with temperature extensions (digit 4)

Integral mount electronics

1	T ≤ +290 °C (+550 °F)	– digit 4: ALL
3	+290 °C (+550 °F) < T ≤ +315 °C (+600 °F)	– digit 4: M, N or P

Remote mount electronics

8	+315 °C (+600 °F) < T ≤ +450 °C (+850 °F)	– digit 4: N or E
---	---	-------------------

APPROVALS & HOUSING

Cast aluminium		Stainless Steel		Housing material	
3/4" NPT	M20	3/4" NPT	M20	Cable entry	Approval
J	K	L	M	Weatherproof	
A	B	C	D	ATEX/IEC and FISCO intrinsically safe	
E	F	G	H	ATEX/IEC (Hart and FF) flameproof enclosure	
5	6	7	8	FM and FISCO intrinsically safe	
1	2	3	4	FM (Hart and FF) Explosion proof	

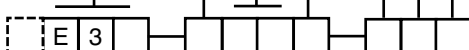

complete code for E3 Module level transmitter – NON STEAM applications

X = product with a specific customer requirement

MODEL IDENTIFICATION – STEAM applications (max 600 lbs)

BASIC MODEL NUMBER

Carbon steel models

E 3 1	top mounted E3 Module level
E 3 3	E3 Module level with side/bottom cage
E 3 5	E3 Module level with side/side cage

Stainless steel models

E 3 2	top mounted E3 Module level
E 3 4	E3 Module level with side/bottom cage
E 3 6	E3 Module level with side/side cage

SPECIFIC GRAVITY AND PROCESS TEMPERATURE (consult factory for interface applications)
Match temperature extensions with max. process temperature (digit 9)

150 °C	200 °C	230 °C	260 °C	370 °C	425 °C	max. temp. / S.G.
K	B	N	E	N	E	0.55 - 1.09 specific gravity

PROCESS CONNECTION

For top mounted connection type

E31/E32 - ANSI Flange rating					E31/E32 - EN 1092-1 (DIN) Flange rating				
150 lbs RF	300 lbs RF	600 lbs		Size	PN 16 Type B1	PN 25/40 Type B1	PN 63 Type B2	PN 100 Type B2	Size
		RF	RJ						
G3	G4	G5	GK	3"	EA	EC	ED	EE	DN 80
H3	H4	H5	HK	4"	FA	FC	FD	FE	DN 100
K3	K4	K5	KK	6"	GA	GC	GD	GE	DN 150

For external cage models

E33 ... E36 - ANSI Flange/Cage rating					E33 ... E36 - EN 1092-1 (DIN) Flange rating				
150 lbs RF	300 lbs RF	600 lbs		Size	PN 16 Type B1	PN 25/40 Type B1	PN 63 Type B2	PN 100 Type B2	Size
		RF	RJ						
P3	P4	P5	PK	1 1/2" flanged	CA	CC	CD	CE	DN 40 flanged
Q3	Q4	Q5	QK	2" flanged					
A3	A4	A5		1 1/2" NPT-F	DA	DC	DD	DE	DN 50 flanged
E3	E4	E5		2" NPT-F					
R3	R4	R5		1 1/2" S.W.					
F3	F4	F5		2" S.W.					

LEVEL RANGE

356	813	1219	1524	1829	2134	2438	2743	3048	mm
14	32	48	60	72	84	96	108	120	inches
A	B	C	D	E	F	G	H	I	code

TRANSMITTER ELECTRONICS

OUTPUT/COMMUNICATION

H	4-20 mA with Hart® communication incl. display / 3 button keypad
F	FOUNDATION Fieldbus communication incl. display / 3 button keypad

MAX PROCESS TEMPERATURE

Match max. process temperature with temperature extensions (digit 4)

Integral mount electronics

1	T ≤ +150 °C (+300 °F)	– digit 4: K
2	+150 °C (+300 °F) < T ≤ +230 °C (+450 °F)	– digit 4: B or N
3	+230 °C (+450 °F) < T ≤ +260 °C (+500 °F)	– digit 4: E

Remote mount electronics

8	+260 °C (+500 °F) < T ≤ +425 °C (+800 °F)	– digit 4: N or E
---	---	-------------------

APPROVALS & HOUSING

Cast aluminium		Stainless Steel		Housing material	
3/4" NPT	M20	3/4" NPT	M20	Cable entry	Approval
J	K	L	M	Weatherproof	
A	B	C	D	ATEX/IEC and FISCO intrinsically safe	
E	F	G	H	ATEX/IEC (Hart and FF) flameproof enclosure	
5	6	7	8	FM and FISCO intrinsically safe	
1	2	3	4	FM (Hart and FF) Explosion proof	



complete code for E3 Module level transmitter –
STEAM applications

X = product with a specific customer requirement

MODEL IDENTIFICATION – NON STEAM applications (from 900 lbs to 2500 lbs)

BASIC MODEL NUMBER

Carbon steel models

E 3 1	top mounted E3 Module level
E 3 3	E3 Module level with side/bottom cage
E 3 5	E3 Module level with side/side cage

Stainless steel models

E 3 2	top mounted E3 Module level
E 3 4	E3 Module level with side/bottom cage
E 3 6	E3 Module level with side/side cage

SPECIFIC GRAVITY AND PROCESS TEMPERATURE (consult factory for interface applications)

Match temperature extensions with max. process temperature (digit 9)

150 °C	200 °C	230 °C	290 °C	315 °C	400 °C	450 °C	max. temp. / S.G.
K	B	N	E	N	N	E	0.55 - 1.09 specific gravity

PROCESS CONNECTION

For top mounted connection type

E31/E32 - ANSI Flange rating			Size	E31/E32 - EN 1092-1 (DIN) Flange rating			Size
900 lbs RJ	1500 lbs RJ	2500 lbs RJ ①		PN 160 Type B2	PN 250 Type B2	PN 320 Type B2	
GL	–	–	3"	EF	EG	EH	DN 80
HL	HM	HN	4"	FF	FG	FH	DN 100
KL	KM	KN	6"	GF	GG	GH	DN 150

For external cage models

E33...E36 - ANSI Flange/Cage rating			Size	E33...E36 - EN 1092-1 (DIN) Flange rating			Size
900 lbs RJ	1500 lbs RJ	2500 lbs RJ ①		PN 160 Type B2	PN 250 Type B2	PN 320 Type B2	
PL	PM	PN	1 1/2" flanged	CF	CG	CH	DN 40 flanged
QL	QM	QN	2" flanged				
AL	AM	AN	1 1/2" NPT-F				
EL	EM	EN	2" NPT-F	DF	DG	DH	DN 50 flanged
RL	RM	RN	1 1/2" S.W.				
FL	FM	FN	2" S.W.				

① Max. 355 bar (5150 psig) @ +40 °C (+100 °F)

LEVEL RANGE

356	813	1219	1524	1829	2134	2438	2743	3048	mm
14	32	48	60	72	84	96	108	120	inches
A	B	C	D	E	F	G	H	I	code

TRANSMITTER ELECTRONICS

OUTPUT/COMMUNICATION

H	4-20 mA with Hart® communication incl. display / 3 button keypad
F	FOUNDATION Fieldbus communication incl. display / 3 button keypad

MAX PROCESS TEMPERATURE

Match max. process temperature with temperature extensions (digit 4)

Integral mount electronics

1	T ≤ +290 °C (+550 °F)	– digit 4: ALL
3	+290 °C (+550 °F) < T ≤ +315 °C (+600 °F)	– digit 4: N

Remote mount electronics

8	+315 °C (+600 °F) < T ≤ +450 °C (+850 °F)	– digit 4: N or E
---	---	-------------------

APPROVALS & HOUSING

Cast aluminium		Stainless Steel		Housing material	
3/4" NPT	M20	3/4" NPT	M20	Cable entry	Approval
J	K	L	M	Weatherproof	
A	B	C	D	ATEX/IEC and FISCO intrinsically safe	
E	F	G	H	ATEX/IEC (Hart and FF) flameproof enclosure	
5	6	7	8	FM and FISCO intrinsically safe	
1	2	3	4	FM (Hart and FF) Explosion proof	



complete order code for E3 Module level transmitter –
NON STEAM applications / high pressure

X = product with a specific customer requirement

MODEL IDENTIFICATION – STEAM applications (from 900 lbs to 2500 lbs)

BASIC MODEL NUMBER

Carbon steel models

E 3 1	top mounted E3 Module level
E 3 3	E3 Module level with side/bottom cage
E 3 5	E3 Module level with side/side cage

Stainless steel models

E 3 2	top mounted E3 Module level
E 3 4	E3 Module level with side/bottom cage
E 3 6	E3 Module level with side/side cage

SPECIFIC GRAVITY AND PROCESS TEMPERATURE (consult factory for interface applications)
Match temperature extensions with max. process temperature (digit 9)

150 °C	200 °C	230 °C	260 °C	370 °C	425 °C	max. temp. / S.G.
K	B	N	E	N	E	0.55 - 1.09 specific gravity

PROCESS CONNECTION

For top mounted connection type

E31/E32 - ANSI Flange rating			Size	E31/E32 - EN 1092-1 (DIN) Flange rating			Size
900 lbs RJ	1500 lbs RJ	2500 lbs RJ ^①		PN 160 Type B2	PN 250 Type B2	PN 320 Type B2	
GL	–	–	3"	EF	EG	EH	DN 80
HL	HM	HN	4"	FF	FG	FH	DN 100
KL	KM	KN	6"	GF	GG	GH	DN 150

For external cage models

E33...E36 - ANSI Flange/Cage rating			Size	E33...E36 - EN 1092-1 (DIN) Flange rating			Size
900 lbs RJ	1500 lbs RJ	2500 lbs RJ ^①		PN 160 Type B2	PN 250 Type B2	PN 320 Type B2	
PL	PM	PN	1 1/2" flanged	CF	CG	CH	DN 40 flanged
QL	QM	QN	2" flanged				
AL	AM	AN	1 1/2" NPT-F				
EL	EM	EN	2" NPT-F	DF	DG	DH	DN 50 flanged
RL	RM	RN	1 1/2" S.W.				
FL	FM	FN	2" S.W.				

^① Max. 355 bar (5150 psig) @ +40 °C (+100 °F)

LEVEL RANGE

356	813	1219	1524	1829	2134	2438	2743	3048	mm
14	32	48	60	72	84	96	108	120	inches
A	B	C	D	E	F	G	H	I	code

TRANSMITTER ELECTRONICS

OUTPUT/COMMUNICATION

H	4 - 20 mA with Hart® communication incl. display / 3 button keypad
F	FOUNDATION Fieldbus communication incl. display / 3 button keypad

MAX PROCESS TEMPERATURE

Match max. process temperature with temperature extensions (digit 4)
Integral mount electronics

1	T ≤ +150 °C (+300 °F)	– digit 4: K
2	+150 °C (+300 °F) < T ≤ +230 °C (+450 °F)	– digit 4: B or N
3	+230 °C (+450 °F) < T ≤ +260 °C (+500 °F)	– digit 4: E

Remote mount electronics

8	+260 °C (+500 °F) < T ≤ +425 °C (+800 °F)	– digit 4: N or E
---	---	-------------------

APPROVALS & HOUSING

Cast aluminium		Stainless Steel		Housing material	
3/4" NPT	M20	3/4" NPT	M20	Cable entry	Approval
J	K	L	M	Weatherproof	
A	B	C	D	ATEX/IEC and FISCO intrinsically safe	
E	F	G	H	ATEX/IEC (Hart and FF) flameproof enclosure	
5	6	7	8	FM and FISCO intrinsically safe	
1	2	3	4	FM (Hart and FF) Explosion proof	

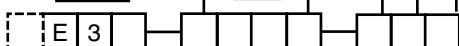

complete code for E3 Module level transmitter –
STEAM applications / high pressure



E3 Modulelevel Displacer Type Transmitter Configuration Data Sheet

Copy blank page and store calibration data for future reference and troubleshooting.
(data can also be printed from PACTware with function print online parameterisation)

Identification

Vessel name	
Vessel #	
Process medium	
Tag #	
Electronics serial #	

Configuration

Item	Screen	Value	Value
Level	«Level»		
Loop	«Loop»		
Level units	«LvlUnits»		
Process SG	«Proc SG»		
Operating temp	«OperTemp»		
4 mA point	«Set 4mA»		
20 mA point	«Set 20mA»		
Level offset	«Lvl Ofst»		
Damping	«Damping»		
System fault state	«Fault»		
Trim level	«Trim Lvl»		
Trim 4 mA	«Trim 4»		
Trim 20 mA	«Trim 20»		
Measurement type	«MeasType»		
Calibration selected	«Calselect»		
Calibrated SG	«Calib SG»		
Dry sensor value	«DrySensr»		
Sensor cal low	«SnsrCalLo»		
Level cal low	«LvlCalLo»		
Sensor cal high	«SnsrCalHi»		
Level cal high	«LvlCalHi»		
LVDT % used	«LVDT%»		
Firmware version	«E3 ModHT»		

IMPORTANT

SERVICE POLICY

Owners of Magnetrol products may request the return of a control; or, any part of a control for complete rebuilding or replacement. They will be rebuilt or replaced promptly. Magnetrol International will repair or replace the control, at no cost to the purchaser, (or owner) **other than transportation cost** if:

- a. Returned within the warranty period; and,
- b. The factory inspection finds the cause of the malfunction to be defective material or workmanship.

If the trouble is the result of conditions beyond our control; or, is **NOT** covered by the warranty, there will be charges for labour and the parts required to rebuild or replace the equipment.

In some cases, it may be expedient to ship replacement parts; or, in extreme cases a complete new control, to replace the original equipment before it is returned. If this is desired, notify the factory of both the model and serial numbers of the control to be replaced. In such cases, credit for the materials returned, will be determined on the basis of the applicability of our warranty.

No claims for misapplication, labour, direct or consequential damage will be allowed.

RETURNED MATERIAL PROCEDURE

So that we may efficiently process any materials that are returned, it is essential that a "Return Material Authorisation" (RMA) form will be obtained from the factory. It is mandatory that this form will be attached to each material returned. This form is available through Magnetrol's local representative or by contacting the factory. Please supply the following information:

1. Purchaser Name
2. Description of Material
3. Serial Number and Ref Number
4. Desired Action
5. Reason for Return
6. Process details

Any unit that was used in a process must be properly cleaned in accordance with the proper health and safety standards applicable by the owner, before it is returned to the factory.

A material Safety Data Sheet (MSDS) must be attached at the outside of the transport crate or box.

All shipments returned to the factory must be by prepaid transportation. Magnetrol **will not accept** collect shipments.

All replacements will be shipped Ex Works.

BULLETIN N°: BE 48-635.2
EFFECTIVE: AUGUST 2016
SUPERSEDES: October 2009

UNDER RESERVE OF MODIFICATIONS



www.magnetrol.com

BENELUX FRANCE	Heikensstraat 6, 9240 Zele, België -Belgique Tel. +32 (0)52.45.11.11 • Fax. +32 (0)52.45.09.93 • E-Mail: info@magnetrol.be
DEUTSCHLAND	Alte Ziegelei 2-4, D-51491 Overath Tel. +49 (0)2204 / 9536-0 • Fax. +49 (0)2204 / 9536-53 • E-Mail: vertrieb@magnetrol.de
INDIA	B-506, Sagar Tech Plaza, Saki Naka Junction, Andheri (E), Mumbai - 400072 Tel. +91 22 2850 7903 • Fax. +91 22 2850 7904 • E-Mail: info@magnetrolindia.com
ITALIA	Via Arese 12, I-20159 Milano Tel. +39 02 607.22.98 • Fax. +39 02 668.66.52 • E-Mail: mit.gen@magnetrol.it
RUSSIA	198095 Saint-Petersburg, Marshala Govorova street, house 35A, office 427 Tel. +7 812 320 70 87 • E-Mail: info@magnetrol.ru
U.A.E.	DAFZA Office 5EA 722 • PO Box 293671 • Dubai Tel. +971-4-6091735 • Fax +971-4-6091736 • E-Mail: info@magnetrol.ae
UNITED KINGDOM	Unit 1 Regent Business Centre, Jubilee Road Burgess Hill West Sussex RH 15 9TL Tel. +44 (0)1444 871313 • Fax +44 (0)1444 871317 • E-Mail: sales@magnetrol.co.uk