

A Higher Level of Performance



Manual

Gladiator

Admittance Smart Switch Series

An All-round Point Level Switch



For more information, please visit >

www.hawkmeasure.com

Table of Contents

Gladiator Admittance Smart Switch Series



Contents

Overview	3	Wiring	13
Principle of Operation	3	Integral Probe Wiring	13
Typical Uses	3	Remote Probe to Amplifier	14
Primary Areas of Application	3	Relay Functions	15
Features	3	Multidrop Connections	16
Function	3	Test Terminal Function Selection (SPDT Only)	17
Typical Applications	4	Setup Procedure	18
Cyclone Bin Level Switch	4	Integral Probe Functionality Layout	18
Presence / Absence of Liquid In Pipe Detection	4	Integral Probe Version	19
Typical Applications	5	Remote Functionality Layout	21
High and Low-level Switch In A Hopper	5	Remote Version	22
Dimensions	6	Main Menu & Interface	23
Remote Amplifier	6	Remote Main Menus & Interface - Remote System	23
Optional Flange	6	Software Parameters	24
Pump Protection Probe	6	Operational Diagnostics (Remote Type Only)	24
Sealing Cover	6	Quickset Menu	25
Remote Probe	7	Advanced Menu	26
Integral Probe	7	Troubleshooting	32
Flexible Cable Probe	8	Remote Version	32
High Temperature Probe (<250°C, <482°F)	9	Part Numbering	33
High Temperature Extensions (<250°C, 482°F)	9	Integral Probe Version	33
High Temperature Probe (450°C, 842°F)	9	Remote Version	34
Mounting	10	Pump Protection Version	35
Mounting Examples	11	Specifications	36
Mounting	11	Dielectric Constants Table	37
Flexible Cable Probe Adjustment	12		
Notes For Adjusting Probe Rope Length	12		

PROPRIETARY NOTICE

The information contained in this publication is derived in part from proprietary and patent data. This information has been prepared for the express purpose of assisting operating and maintenance personnel in the efficient use of the instrument described herein. Publication of this information does not convey any rights to use or reproduce it, or to use for any purpose other than in connection with the installation, operation and maintenance of the equipment described herein.

WARNING

This instrument contains electronic components that are susceptible to damage by static electricity. Proper handling procedures must be observed during the removal, installation, or handling of internal circuit boards or devices:

Handling Procedure:

1. Power to unit must be removed prior to commencement of any work.

2. Personnel must be grounded, via wrist strap or other safe, suitable means, before any printed circuit board or other internal devices are installed, removed or adjusted.
3. Printed circuit boards must be transported in a conductive bag or other conductive container. Boards must not be removed from protective container until the immediate time of installation. Removed boards must be placed immediately in a protective container for transport, storage, or return to factory.

Comments:

This instrument is not unique in its content of ESD (electrostatic discharge) sensitive components. Most modern electronic designs contain components that utilize metal oxide technology (NMOS, CMOS, etc.). Experience has proven that even small amounts of static electricity can damage or destroy these devices. Damaged components, even though they appear to function properly, exhibit early failure

Overview

Gladiator Admittance Smart Switch Series



Principle of Operation

The probe of the Admittance Switch forms one plate of a capacitance circuit, with the vessel wall making the second plate. The dielectric constant of the product between the probe and the vessel wall will cause a change of capacitance as the level approaches the probe. The change is detected, amplified and used to switch a relay for indication or control purposes. A special circuit is used to ignore product build-up between the sensing probe (active element) and guard, and also between the guard and vessel wall.

Typical Uses

- Failsafe high-level / low-level alarm
- High-level alarm
- Low-level alarm
- Blocked chute / Plugged chute
- Interface detection
- Pump control.

Primary Areas of Application

- Asphalt
- Glass
- Plastics
- Brewing
- Mining & Metals
- Power Generation
- Cement
- Oil & Gas
- Refining
- Chemical
- Packaging
- Semiconductor
- Dairy
- Paint
- Sugar
- Edible oil
- Paper
- Textile
- Fertilizer
- Pharmaceutical
- Water & Wastewater.
- Food & Beverage

Function

The Gladiator Admittance Smart Switch is point level switch for liquids, solids and powders.

The unit is suitable for a broad range of products and dielectric constants up to high temperature of 450°C (842°F).

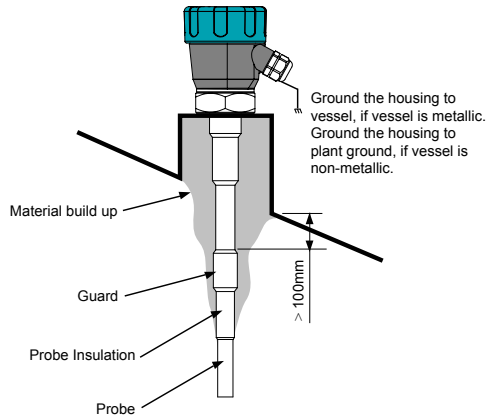

Features

- Excellent immunity to product build-up
- Excellent temperature stability - no false trips
- Non contact switching possible with many products
- Simple '1-minute' setup
- Remote sensor or Integral 'all in one' types
- Relay outputs: Integral probe (1) Remote (2)
- Remote test function
- Adjustable ON and OFF delays (0-20 sec)
- Remote 3G Connection option
- Remote amplifier to probe separation up to 500m (1640ft)
- Bright visual status indication on Probe
- Independent housing alignment after mounting thread locked.

Typical Applications

Gladiator Admittance Smart Switch Series



Cyclone Bin Level Switch

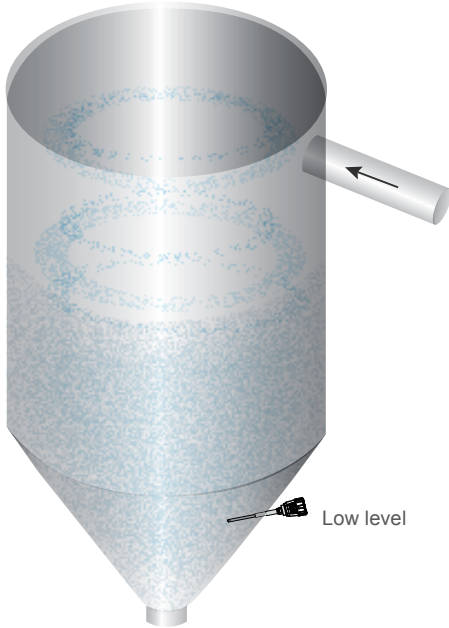

High level switch in grain application



High level switch in plastic pellet silo



Presence / Absence of Liquid In Pipe Detection

Sealing plug available allowing removal of unit without pipe leakage

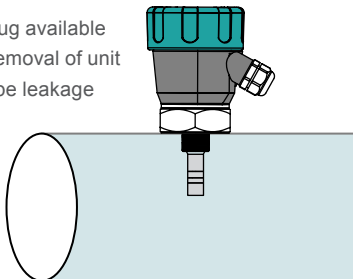

Typical Applications

Gladiator Admittance Smart Switch Series



High and Low-level Switch In A Hopper

High level (top mounted)

Low level (top mounted)

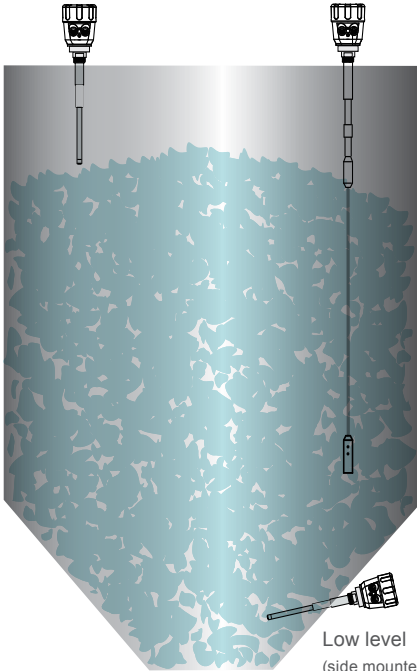

Low level
(side mounted)

Continuous filling with build-up on probe



If impact from falling material is expected, mount a protection plate above the probe to ensure no physical damage can occur to the probe in normal operation. If it is not possible to do this or to move the probe to an alternative position, use a microwave switch.

See www.hawkmeasure.com for further information on Microwave switches and other level products.

Dimensions

Gladiator Admittance Smart Switch Series



Remote Amplifier

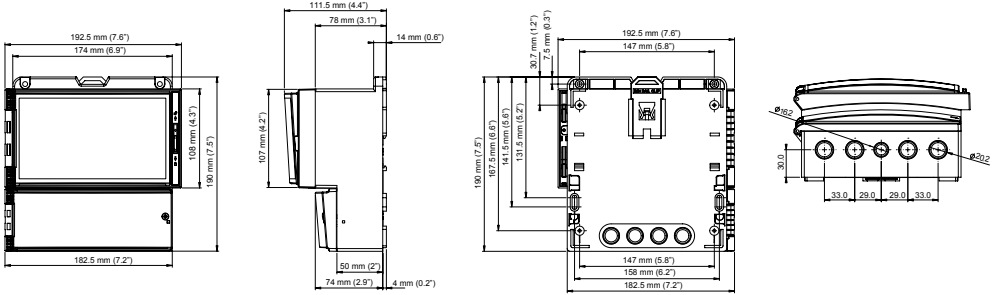

Optional Flange

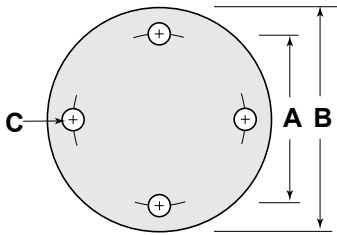

Flange Dimensions - 50mm (2")						
	A		B		C	
ANSI (Class 150)	120.7	4.75"	152.4	6"	19.1	0.75"
DIN (PN40)	125	4.9"	165	6.5"	18	0.7"
JIS (10K)	120	4.7"	155	6.1"	19	0.75"

Pump Protection Probe

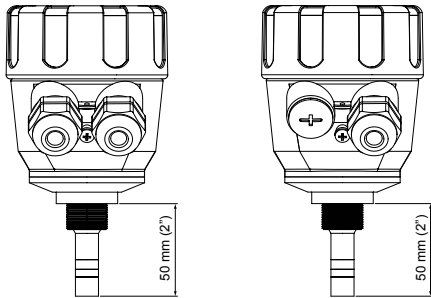

Sealing Cover

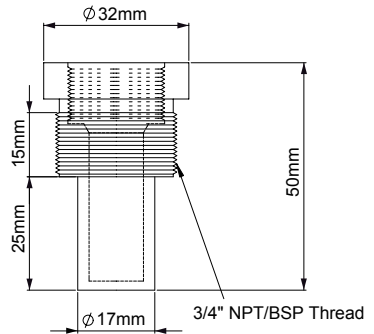

Dimensions

Gladiator Admittance Smart Switch Series



Remote Probe

Integral Probe

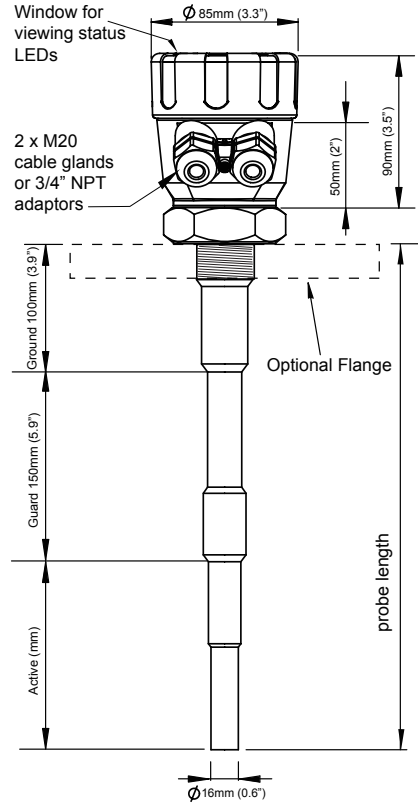
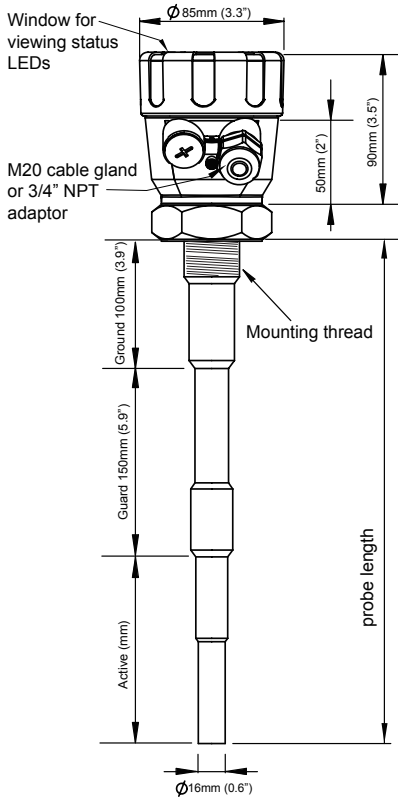

Probe Length (mm, inch)	Active	+ Guard + Ground
P05 (50mm, 2")	= 15mm, 0.6"	+ 35mm, 1.4"
P30 (300mm, 11.8")	= 50mm, 2"	+ 250mm, 9.8"
P50 (500mm, 19.7")	= 250mm, 9.8"	+ 250mm, 9.8"
P100 (1000mm, 39.4")	= 750mm, 29.5"	+ 250mm, 9.8"

Dimensions

Gladiator Admittance Smart Switch Series



Flexible Cable Probe

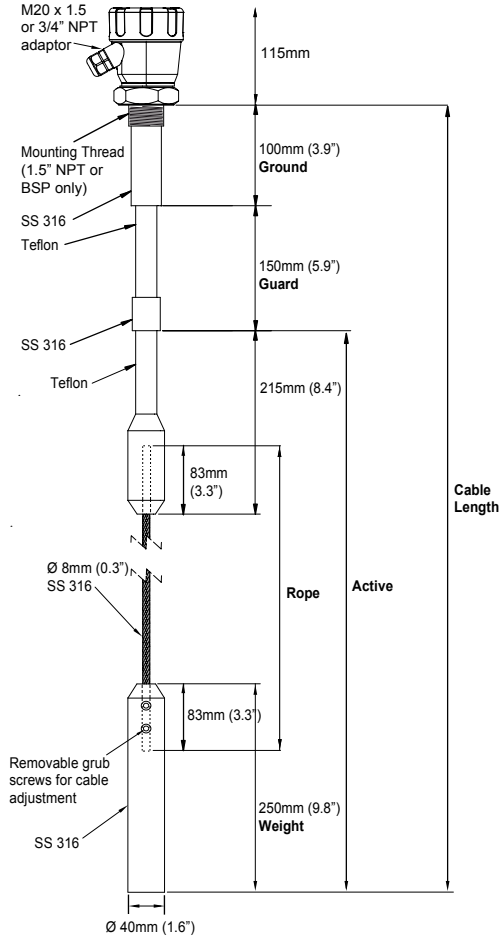

Probe Length (mm, inch)	Active	+ Guard + Ground	(Rope Length)
C100 (1000mm, 39.3")	= 750mm, 29.5"	+ 250mm, 9.8"	451mm, 17.8"
C200 (2000mm, 78.7")	= 1750mm, 68.9"	+ 250mm, 9.8"	1451mm, 57.1"
C300 (3000mm, 118.1")	= 2750mm, 108.3"	+ 250mm, 9.8"	2451mm, 96.5"

Dimensions

Gladiator Admittance Smart Switch Series



High Temperature Probe (<250°C, <482°F)

High Temperature Probe (450°C, 842°F)

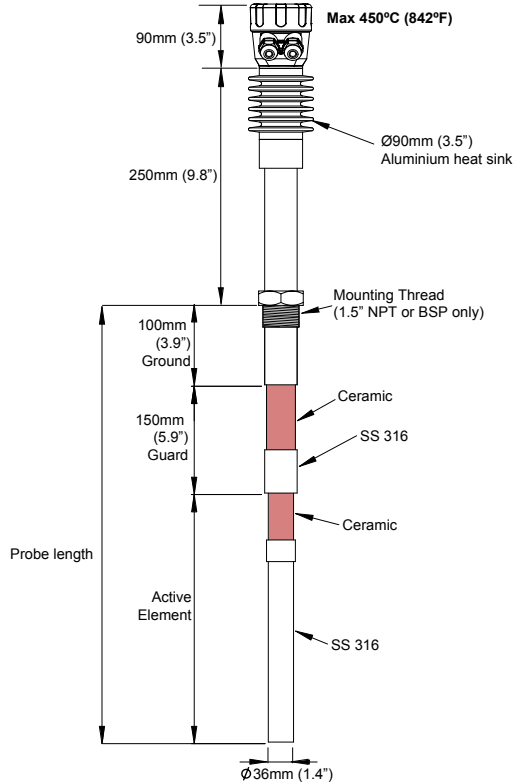
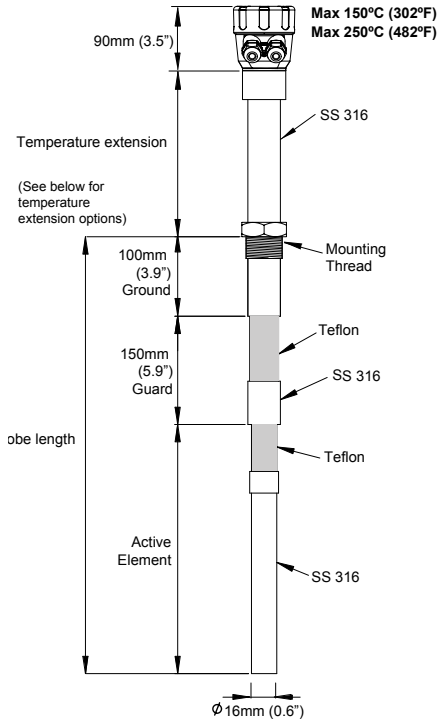

High Temperature Extensions (<250°C, 482°F)

Remote Probe or Integral Probe

X mm:

- Max. 80°C (176°F) ~ no temperature extension required
- Max. 150°C (302°F) ~ 150mm (5.9")
- Max. 250°C (482°F) ~ 250mm (9.8")
- For the 450°C (842°F) Probe, different extension applies.

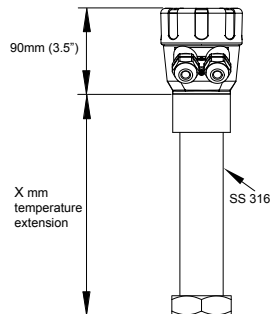

Mounting

Gladiator Admittance Smart Switch Series



Probes can be mounted from the top, side and bottom.

Points to consider when mounting:

A. Material infeed clearance

Install the probe away from the infeed to minimize the influence of build-up and impact forces, and to avoid false triggering from product flow.

B. Wall clearance

Install the probe far enough away from the wall to prevent the probe or cable from coming into contact with the vessel wall. Avoid creating a confined area where material could build-up over time.

See note ②

C. Nozzle clearance

Where possible, ensure the probe guard has at least 100mm clearance from the nozzle.

Correct Mounting in a Nozzle

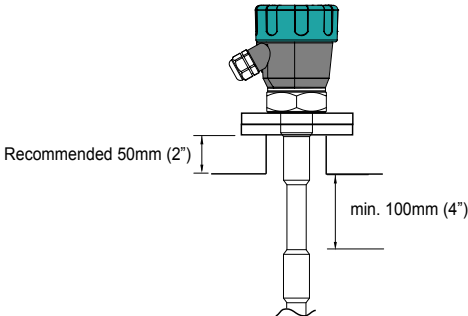

D. Top mounting

When top mounting, ensure adequate clearance is provided between probe and wall. Avoid creating a confined area where material could build-up over time. In the case of cable probe versions, ensure enough clearance is provided between the probe and wall to allow for build-up of material occurring on the wall.

See note ②

E. Side mounting

It is highly recommended to install any side mounted probe at a downward angle of 30-45°. Use a protection plate for side mounting where the probe may be subject to impact strain or collapsing material.

F. Bottom mounting

Bottom mounting is not recommended. Only mount from the bottom if no build-up of material occurs. If low level mounting is required, suitable options are shown in the diagram on page 11.

CORRECT MOUNTING NOTES:

(Refer to picture on page 11)

① Select correct probe for high temperature applications.

Allow adequate air flow for cooling extensions dissipate heat.

INCORRECT MOUNTING NOTES:

② Incorrect mounting because the probe is too close to the wall or roof. Positioning too close to a wall or roof will limit probe sensitivity. Material may build-up between the probe and the vessel.

③ Incorrect mounting because the probe's guard is mounted inside the nozzle. The correct arrangement is for the guard to protrude out of the mounting pipe at least 100mm. Product will build-up in the nozzle.



Mounting

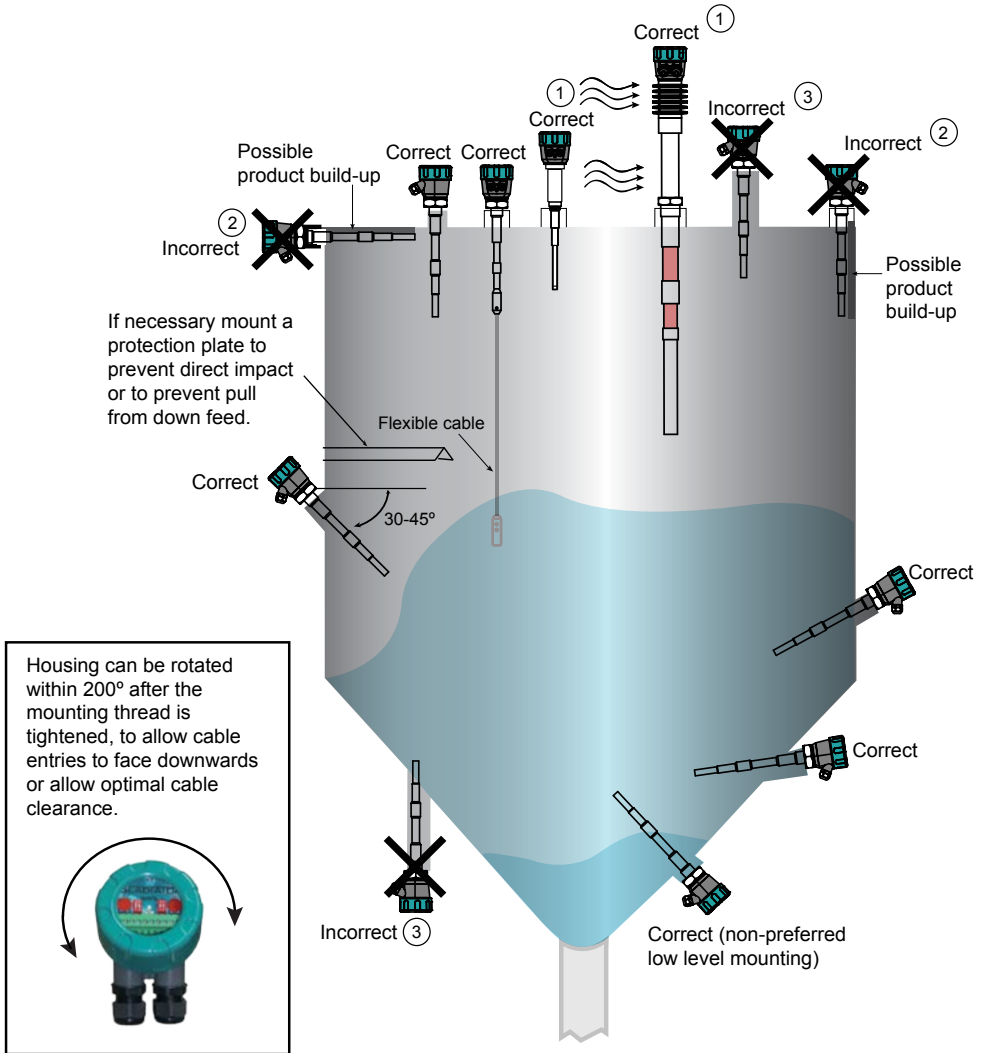

Flexible Cable Probe Adjustment

Gladiator Admittance Smart Switch Series



Notes For Adjusting Probe Rope Length

The Gladiator rope type probe can be altered to any sensing length between approx. 750mm and 3m by cutting down from the standard sizes as required.

If a new rope is to be used, the rope should be cut to:

Cable probe length - 549mm = new wire rope length (total sensing length - 549mm)

For example, within a 1000mm (1m) cable:

$$1000 = [\text{rope} + 549]$$

So rope length = 451mm

Remove or install the probe weight grub screws with a 4mm Allen key.

When fastening the rope, apply thread-locking adhesive onto grub screws before re-installation.

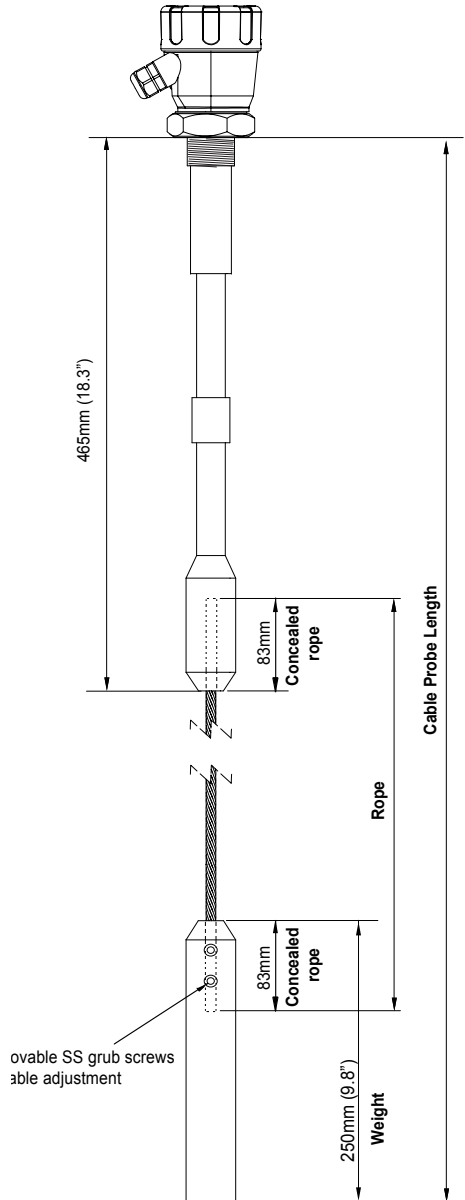



Integral Probe

Remove Plug-In terminal block for easier wiring.



The AC earth/ground cable must be connected to the ground screw inside the housing when using AC power.

Hole for securing of optional identification tag

M4 grounding screw

If only one cable is used for both power and output signal, then the second entry port must be plugged or blinded. Every Smart unit is supplied with two M20 glands (or 3/4"NPT adaptors) mounted on the unit and one blind plug loose.

Ground the housing to vessel, if vessel is metallic.
Ground the housing to plant ground, if vessel is non-metallic.

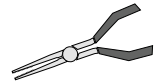

User pliers to extract terminal blocks

Terminal Layout - Output Option S (SPDT)

RELAY				COMMS		DC-IN		AC-IN	
1. NC	2. COM	3. NO	4. Test	5. A	6. B	7. +	8. -	9. N	10. L1
				RS 485		12-30Vdc		80-265Vac	

Terminal Layout - Output Option D (DPDT)

RELAY						DC-IN		AC-IN	
1. NC1	2. COM1	3. NO1	4. NC2	5. COM2	6. NO2	7. +	8. -	9. N	10. L1
						7-30Vdc		80-265Vac	



Remote Probe to Amplifier

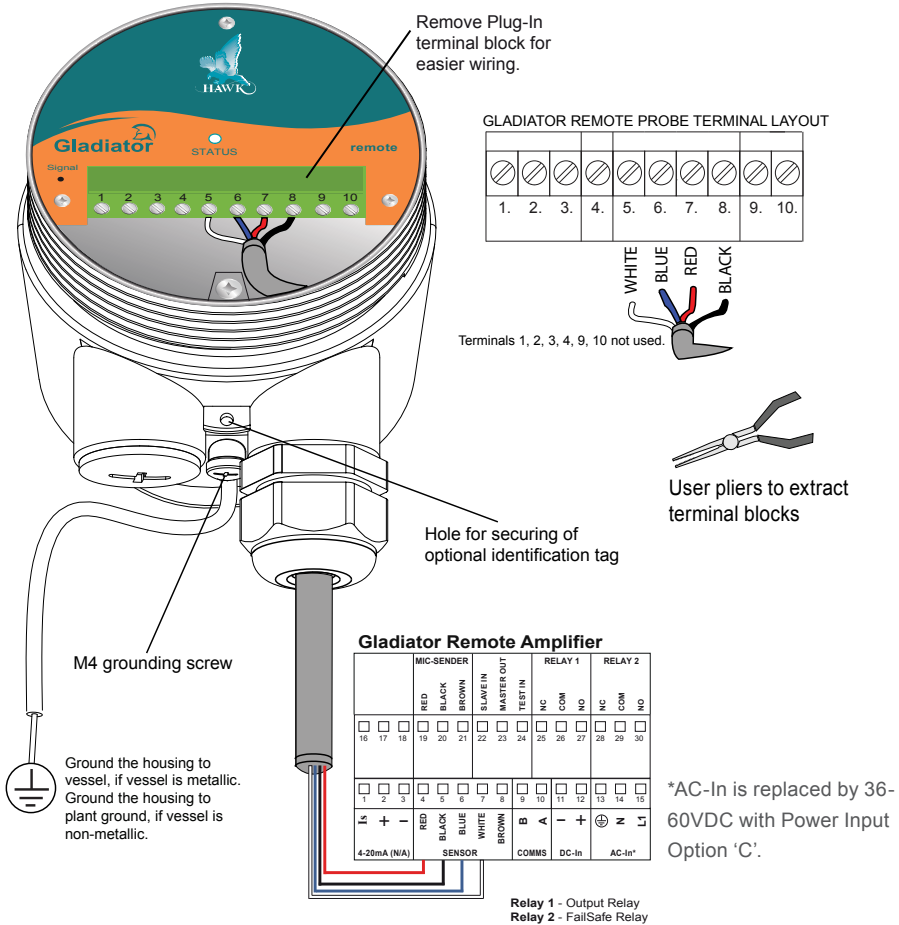

Cable type between Amplifier and Probe

- Cable type between Amplifier and Probe
- 4 conductor shielded twisted pair instrument cable
- Conductor size dependent on cable length
- BELDEN 3084A, DEKORON or equivalent
- Max: BELDEN 3084A = 500m (1640ft)
- Max: DEKORON IED183AA002 = 350m (1150 ft).



Relay Functions

Level Switch Contact Action

Relay - for Integral Probe Version
(Set *Relay Action selection switch* page 18)

Relay 1 - for Remote Version
(Set *'Relay Action' parameter* pages 25 and 26)

*It is possible for the Gladiator to switch state before actual product contact with the probe. State 2 represents product being detected by the probe, even if it occurs without contact.

		Relay Action	
		FailSafe Low FSL	FailSafe High FSH (default)
State 1 	<p>1 2 3 NC COM NO</p>	<p>1 2 3 NC COM NO</p>	
	State 2 	<p>1 2 3 NC COM NO</p>	<p>1 2 3 NC COM NO</p>
State 1 	<p>1 2 3 NC COM NO</p>	<p>1 2 3 NC COM NO</p>	
	POWER FAILURE	<p>1 2 3 NC COM NO</p>	<p>1 2 3 NC COM NO</p>

Relay Status
Smart Probe terminal numbers
Remote Amplifier terminal function labels
LED Status

FailSafe Switch Contact Action

Relay 2 - Remote version only.
For Integral Probes the Test terminal can act as a solid state output with a similar function. (See page 17)

POWER FAILURE OR INTERNAL FAILURE	<p>1 2 3 NC COM NO</p>	<p>1 2 3 NC COM NO</p>
SYSTEM OPERATING NORMALLY	<p>1 2 3 NC COM NO</p>	<p>1 2 3 NC COM NO</p>



Multidrop Connections

Multidrop GPRS Connection*

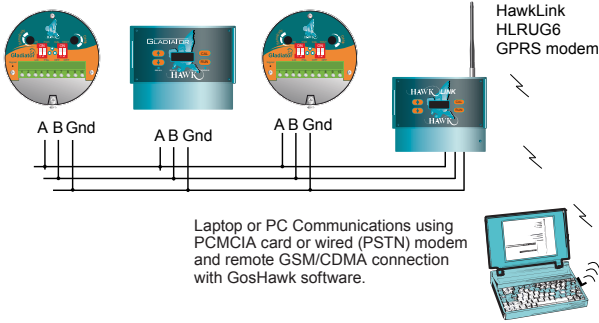

Multidrop Connection Using HawkLink USB*

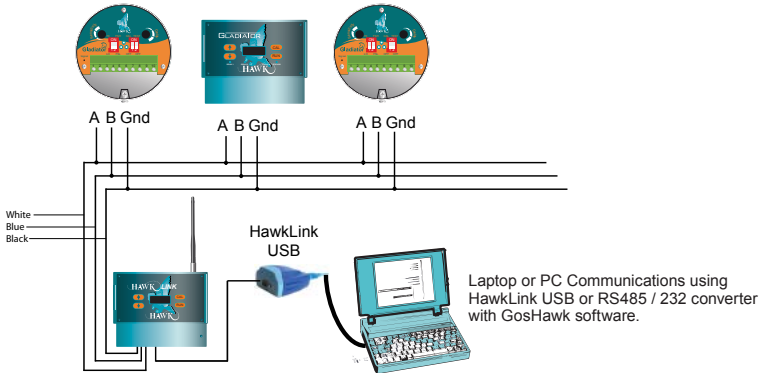

Multidrop Connection to PLC/DCS/SCADA*

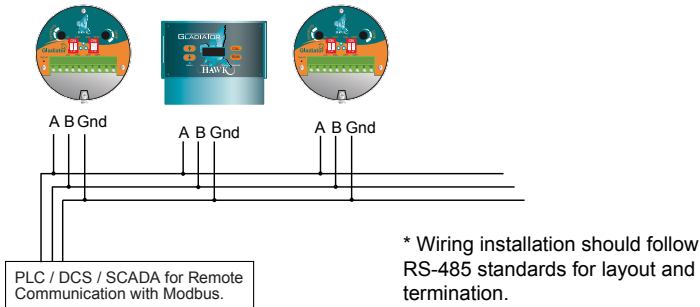



Test Terminal Function Selection (SPDT Only)

Test input mode

Test switch must be in 'TEST' (ON) position on Integral Probe - function always enabled on Remote Amplifier. Test terminal acts as an input for remote testing of the instrument's switching function. Used to check for malfunction of unit from a remote position, PLC, SCADA etc. For more information see page 20.

TEST INPUT FROM PLC/SCADA/DCS DIGITAL OUTPUT

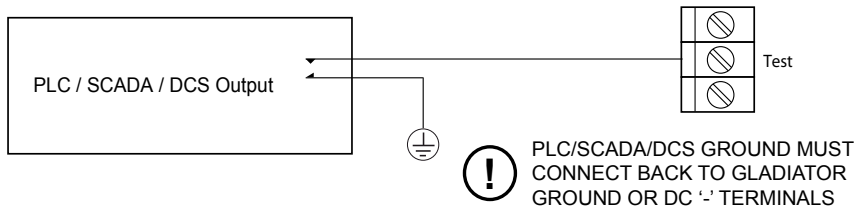

OPERATOR CONTROLLED PRESS TO TEST

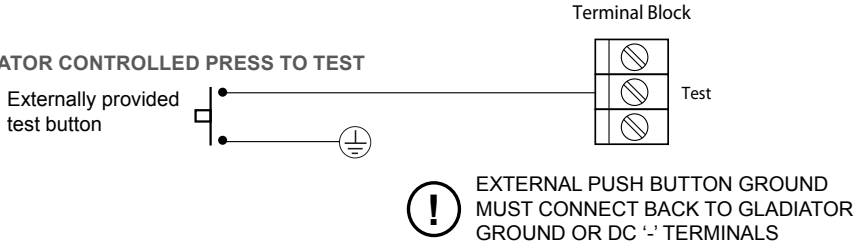

FAILSAFE OUTPUT MODE (Test switch must be in the 'OFF' position - default setting)

Test terminal will provide an output which is able to switch an external failsafe relay or PLC/SCADA/DCS input. During normal system operation this terminal will internally switch a solid state (transistor) output to ground (or DC '-'). If power fails or an internal system failure occurs, the terminal will act as an open circuit.

To switch an external relay

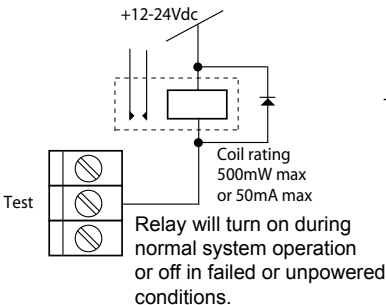

To a PLC input

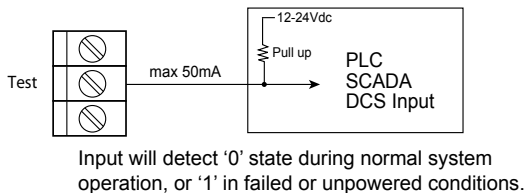



Integral Probe Functionality Layout

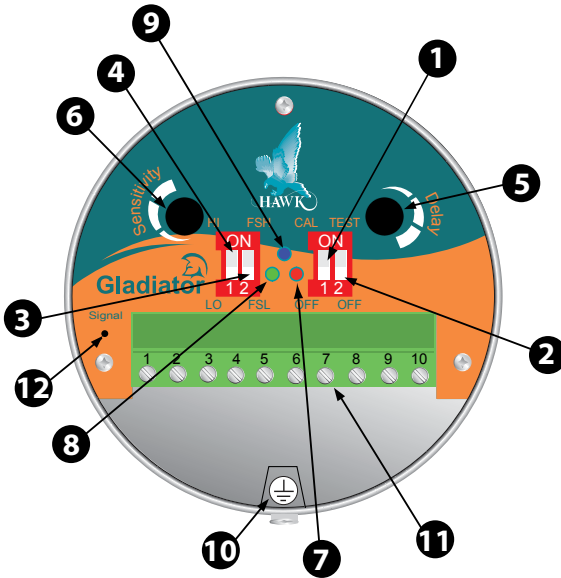

Functionality Description (bold is default)

- 1** Mounting Calibration switch **CAL/OFF**
- 2** Test input function select **TEST/OFF**
- 3** Relay action selection switch
FSH - FailSafe High
FSL - FailSafe Low
- 4** **HI / LO** sensitivity switch
- 5** Delay Potentiometer (0-20 sec)
(Default 0 sec. at minimum position)
- 6** Sensitivity Potentiometer
Default **50%** = **12 o'clock**
- 7** **RED LED**: Relay status
ON when relay coil is energised
- 8** **GREEN LED**: Power / Status
Blinks to indicate the functioning is correct and no media is detected.
Continuously ON when media is detected.
- 9** **BLUE LED**:
Blinking indicates calibration function is on.
Continuously ON indicates failed calibration.
- 10** **AC Ground** - must be used for AC powered installations
- 11** Removable terminal block - plug in type
- 12** Signal voltage test point
- Not used in Gladiator Admittance products



Integral Probe Version

1. Mount the unit in its actual position.

(See mounting procedure - pages 10-11)

- Make sure that external ground wire is connected between the outside ground screw on the Gladiator housing and the roof/wall/side of the silo/tank/vessel/chute (for non metallic tanks make sure that external ground wire is connected between the same outside ground screw on the housing and the general plant ground potential).

2. Check where the actual level is relative to the probe

- Make sure that product is not touching the probe - ideally it needs to be > 500mm away (if the silo/vessel/tank/chute is very small you must ensure that the material is as far away as possible - it must not be touching the probe).

3. Turn the power on

- The green LED will either stay on for 2 seconds then begin flashing or stay on permanently to indicate operation.

4. Select the required relay contact action

- The Relay can switch 'ON' or 'OFF' as the product approaches the probe and switch 'ON' or 'OFF' in response to an instrument failure *(for details see page 15)*.
- Set the relay action selection switch position (FSL or FSH) depending on your requirements.

5. Cancel influence of mounting and/or build up

- Do not proceed with this step unless the product is not touching the probe. Ideally the level needs to be > 500mm away.
- Switch the Mounting Calibration switch to 'CAL' (ON) position.
- The Blue LED will blink to indicate that mounting calibration is now in progress.
- Wait for at least 10 sec. then switch the mounting calibration switch to 'OFF' position.
- The Blue LED should turn off after a short time.
- The Blue LED will stay on if there was a calibration error.
- If this is the case please check that the probe is not touching the product or the mounting, then try the calibration again.
- If mounting calibration was successful the blue LED should be off and the Green LED should blink every 2 sec.
- Unit is now able to cancel influence of mounting and/or build-up and probe history has been cleared.
- The reverse is also true.



Integral Probe Version

6. Select the sensitivity

There are two adjustments controlling the sensitivity of the switch point:

6.1. The 'HI/LO' sensitivity switch is used to set your unit depending on the dielectric properties of the product to be measured. This switch sets the range of adjustment possible with the sensitivity potentiometer.

- If the material to be detected has a lower dielectric constant than 10 - set the switch to 'HI' (ON)-default.
- If material to be detected has a higher dielectric constant than 10 - set switch to 'LO'.
- If you are not aware of your material dielectric constant – set the switch to 'HI' (ON) - default.

6.2 The sensitivity potentiometer

- Set the potentiometer according to your requirements.
- A 12 o'clock setting (50%) - default, will cover the majority of instances - for the remaining instances, turning the potentiometer anti clockwise will decrease sensitivity.
- Switch point will then occur with the material nearer to the probe or more in contact with the probe than before.

7. Select the time delay

- Set the required delay using the Delay potentiometer (Default is 0 sec. at minimum position).
- Turn the potentiometer clockwise if any delay is required.
- Maximum rotation is $\frac{3}{4}$ of a revolution.
- Max delay is 20 sec.
- The selected delay will be used for both an ON delay and an OFF delay.*

8. Test function

(used to check for malfunction of unit from remote position, PLC, SCADA etc)

- Select the desired Test function by switching the 'Test' switch (Default = 'OFF').
- **TEST' (ON) Position:**
 - Test function is selected.
 - Test terminal (terminal number 4 of Integral probe) is used as an input to the unit.
 - The test function allows you to check the functionality of the unit.
 - Applying a ground wire to the Test terminal will change the state of the relay. It will hold this state until the ground is removed, then it will change back to the standard running mode.
 - If the unit was in a Fail mode then the relay will not change status.
- **'OFF' (Default) Position:**
 - Fail safe output function is selected.
 - Test terminal (terminal number 4 of Integral probe) will function as an open drain drive.
 - This can be used to drive a relay or an active low PLC input to detect a Fail condition.
 - In normal operation mode the Test terminal will output Zero Volts (Short to GND).
 - In Fail or unpowered mode the Test terminal will be open circuit.

**Setting of different time ranges for the delay potentiometer for ON delay and OFF delay is possible using a PC connected via GosHawk II software. By default, both will have the same time adjustment range (20 sec max) and adjustment will result in equal ON delay and OFF delay.*

Setup Procedure

Gladiator Admittance Smart Switch Series



Remote Functionality Layout

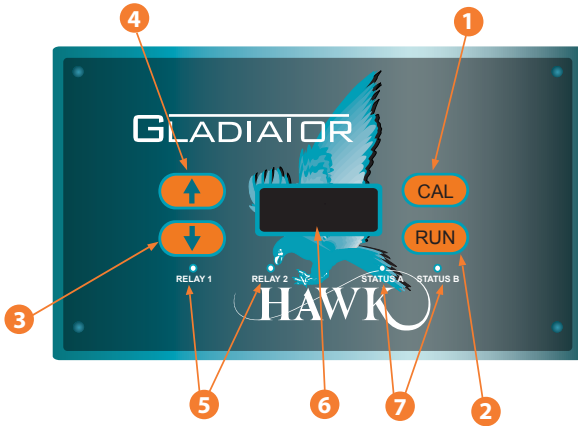

- 1** Calibrate button
- 2** Run button
- 3** Down button
- 4** Up button
- 5** Relay status LEDs 1 and 2
- 6** Display (LCD with backlight)
- 7** Status LEDs A and B
 - Status A flashes with probe to amplifier communications
 - Status B has no function in this product

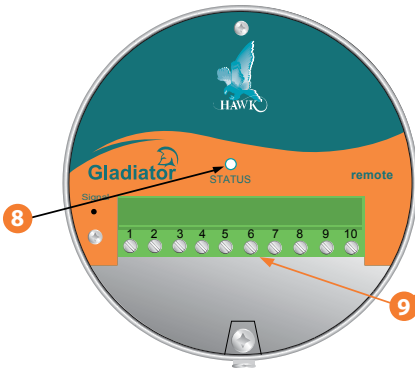

REMOVABLE REMOTE PROBE TERMINAL BLOCK

1.	2.	3.	4.	5.	6.	7.	8.	9.	10.

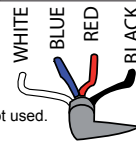

Terminals 1, 2, 3, 4, 9, 10 not used.

- 8** GREEN LED: Power / Status
 Blinks every 1/2 second to indicate that functioning is correct and no medium is detected.
 LED on continuously indicates correct functioning and media is detected.
- 9** Removable terminal block - plug in type



Remote Version

1. Mount the unit in its actual position.

(See mounting procedure - page 10-11)

- Make sure that external ground wire is connected between the outside ground screw on the Gladiator housing and the roof/wall/side of the silo/tank/ vessel/chute (for non metallic tanks make sure that external ground wire is connected between the same outside ground screw on the housing and the general plant ground potential.).

2. Check where the actual level is relative to the probe.

- Make sure that product is not touching the probe - ideally it needs to be > 500mm away (if the silo/ vessel/tank/chute is very small you must ensure that the material is as far away as possible - it must not be touching the probe).

4. Simple “1-minute” Setup - Follow the flow chart

<p>Sensor Value 0.0%</p> <p>Press ESC OK</p> <p>Unlock 0</p> <p>Press ESC OK</p> <p>QuickSet</p> <p>Press ESC OK</p> <p>Dielectric 0-10</p> <p>Press ESC OK</p> <p>Press UP DOWN</p> <p>Cal Mounting Yes / No</p> <p>Press ESC OK</p> <p>Press UP DOWN Yes</p> <p>Press ESC OK</p> <p>Switch Point 50%</p> <p>Press ESC OK</p> <p>Press UP DOWN 50%</p> <p>Press ESC OK</p> <p>On Delay Adj Off Delay Adj</p> <p>Press ESC OK</p> <p>Press UP DOWN 0.1S</p> <p>Press ESC OK</p> <p>Relay Action FailSafe Hi</p> <p>Press ESC OK</p> <p>Press UP DOWN FailSafe Hi</p> <p>Press UP DOWN FailSafe Low</p> <p>Press ESC OK</p>	<p>Select Dielectric Constant Under 'App Type' select Dielectric closest to the measured material</p> <hr/> <p>Cancel Influence of Mounting and/or Buildup Do not proceed with this if material is covering the probe. Ideally it should be > 500mm away. Select 'Yes' to start the mounting calibration. 'Wait' will be displayed during the calibration for up to 30 seconds. Unit is now able to cancel the influence of the mounting and/or build-up. The % reading has been zeroed with the existing process conditions and probe history log has been cleared.</p> <hr/> <p>Select the Switch point The output relay will switch at the entered % value. The default value of 50% will be suitable for detecting most media. For detection of products having low dielectric constant, select a lower % value and vice versa. A higher % value will require the product to come nearer to the probe or cover more of the probe before switching will occur. When the level falls the relay will switch back at half of the entered switch point % value.</p> <hr/> <p>Select the Relay on / off time Delay Set the time to be used for each of the switch on and switch off delays.</p> <hr/> <p>Select the required relay action The Relay can switch 'ON' or 'OFF' as the product approaches the probe and switch 'ON' or 'OFF' in response to an instrument failure. For details see <i>page 15</i>.</p>
--	--

3. Turn the power on

- The display will turn on and the failsafe relay will switch.
- The display will scroll through the following messages: Hawk, Amp SerialNo, Type, Amp SoftVer, Device ID, SensorSerial, SensorModel, Sens SoftVer, Sensor Addr, Gladiator System Amp.
- The unit will then go into operational mode displaying 'Switch' with a % value. This % value represents the changing admittance reading.

Main Menu & Interface

Gladiator Admittance Smart Switch Series



Remote Main Menus & Interface - Remote System

Note: Parameters may vary depending on older software revisions

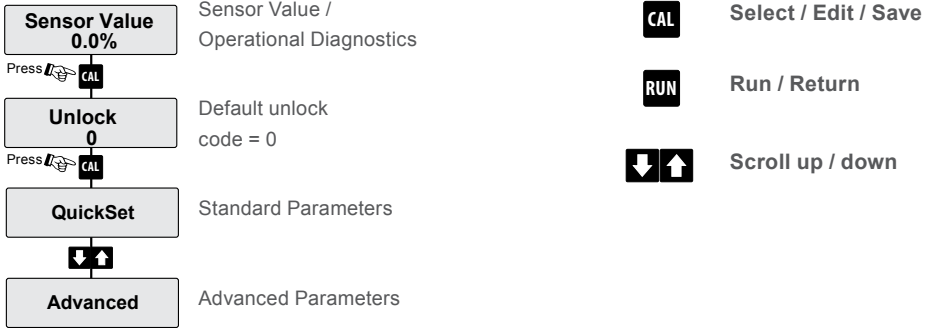



Operational Diagnostics (Remote Type Only)

The diagnostic displays appear on the top line of the LCD, after pressing the Up or Down push button when the Gladiator is in its normal running mode.

The diagnostics provide the user with valuable performance feedback on how the instrument is performing whilst in operation.

The measured reading Sensor Value (%) continues to be displayed on the second line of the LCD during diagnostic viewing on the top line. Output relays will continue to operate during diagnostic viewing.

Diagnostic	Description	Notes
Sensor Value	Sensor value indicates detected material. 0% indicates nothing is touching the probe. The peak amount of % depends on the Display Span setting.	This % is also used by the Switch Point parameter for relay control.
<ul style="list-style-type: none">• Normal• Failed	<ul style="list-style-type: none">• Unit in normal operation• Unit is in failsafe condition	
Temp	Measured temperature inside probe housing.	
Delay	Dynamic switch delay time indication	
Min	The minimum recorded Sensor Value % since last log reset	
Max	The maximum recorded Sensor Value % since last log reset	
SW Off	For the level relay to switch to state '1', the Sensor value must drop below this SW Off % for the duration of the off delay time.	Switch mode 'Auto' will automatically set the SW Off % to 1/2 of SW On %
SW On	For the level relay to switch to state '2', the Sensor value must exceed this SW On % for the duration of the on delay time.	

Software Parameters

Gladiator Admittance Smart Switch Series



Quickset Menu - Parameters

Parameter	Description	Options
App Type	Select pre-configured settings based on Dielectric Constant of the measured material	<ul style="list-style-type: none">• Dielectric 0-10• Dielectric 0-5• Dielectric 10-50• Dielectric >50
Cal Mounting	Performs a Cal Mount in which the unit automatically configures itself based on the selected App Type and the mounting environment. Vessel must be empty.	<ul style="list-style-type: none">• Yes / No
Switch Point	This is the switch on / off sensor value % for relay actions. In 'Auto' mode (set in Advanced menu) switch off will be default to 1/2 of this value.	<ul style="list-style-type: none">• Adjustable
On Delay Adj	Set on delay time for relay 1.	<ul style="list-style-type: none">• Adjustable in seconds
Off Delay Adj	Set off delay time for relay 1.	
Relay1Action	Adjust the Relay action to be energised or de-energised during normal operation	<ul style="list-style-type: none">• FailSafe Hi• FailSafe Low
Lock Code	Set a lock code to prevent unauthorised access	<ul style="list-style-type: none">• Default 0





Advanced Menu - Parameters

Parameter	Description	Sub Menu
Switch Mode	<ul style="list-style-type: none"> • Auto - Switch On% set in Quickset, Switch Off% automatically configured • Manual - Manually adjust Switch On and Switch Off % 	<ul style="list-style-type: none"> • Switch On% • Switch Off%
Relay2Action	<p>Set Relay2Action as one of the below:</p> <ul style="list-style-type: none"> • Failsafe - Relay2 triggers on failsafe conditions • Relay2 - Mirrors Relay1 action to act as a second / backup relay for the system 	<ul style="list-style-type: none"> • Failsafe • Relay2
View Log	View logged data since last re-set or cal mount	<ul style="list-style-type: none"> • Min Sensor% • Max Sensor% • Min Temp • Max Temp
Reset Log	Reset logged data	<ul style="list-style-type: none"> • Yes • No
Comms Type	Adjust & select additional communications, baud rate and device ID. All GSA units by default include Modbus.	<ul style="list-style-type: none"> • DeviceNet (not functional) • Profibus (not functional) • HART (not functional) • Modbus / Device ID / Baud Rate
Back Light	Turn on / off LCD backlight	
Display Span	Changes the displayed Sensor% multiplier. This will not adjust any performance based function of the unit, only the digits used to display the Sensor%.	<ul style="list-style-type: none"> • Span 0 - 40000 • Span 1 - 30000 • Span 2 - 20000 • Span 3 - 10000 • Span 4 - 5000 • Span 5 - 1000
Probe Avg	Probe Avg is a output damping parameter. Increase to smooth out unwanted fluctuations or instability of Sensor%.	<ul style="list-style-type: none"> • Adjustable (default 4)
LoadDefaults	Reset system to defaults (amplifier and/or sensor)	<ul style="list-style-type: none"> • Yes • No
InputVolChk	Used for power related failsafe. When active the unit will switch to failsafe mode if input voltage drops below required power. When not active unit will display 'Input Voltage too low' on the display if input voltage drops below required power.	<ul style="list-style-type: none"> • Yes • No



Diagnostics

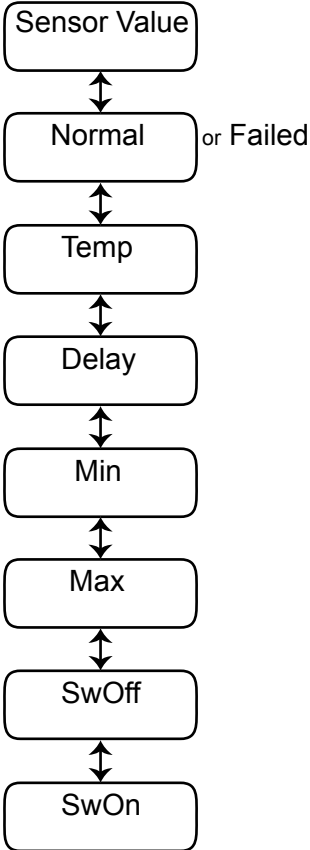

QuickSet

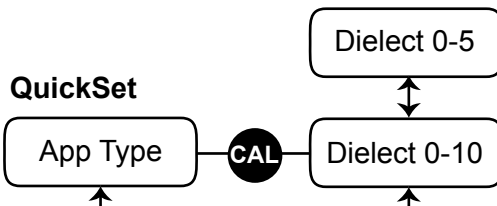

Software Flow Chart

Gladiator Admittance Smart Switch Series

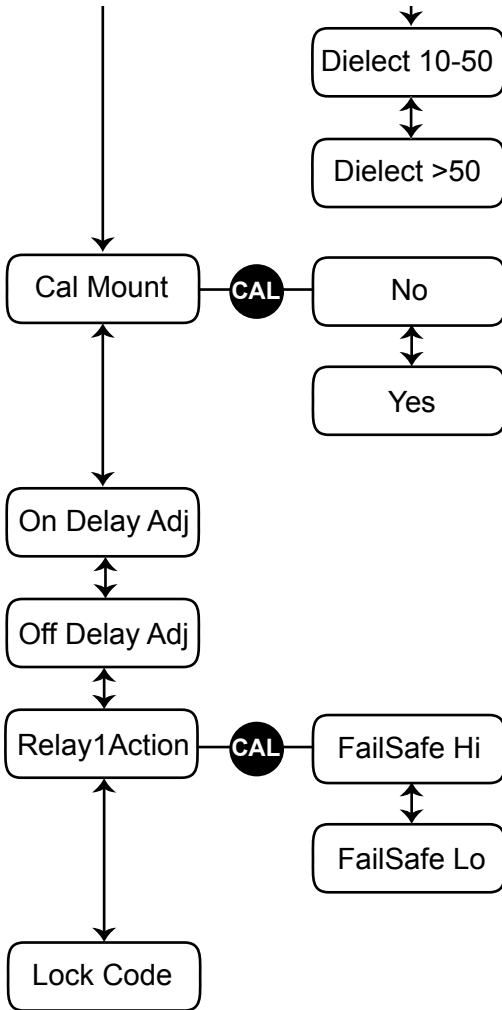

Software Flow Chart

Gladiator Admittance Smart Switch Series

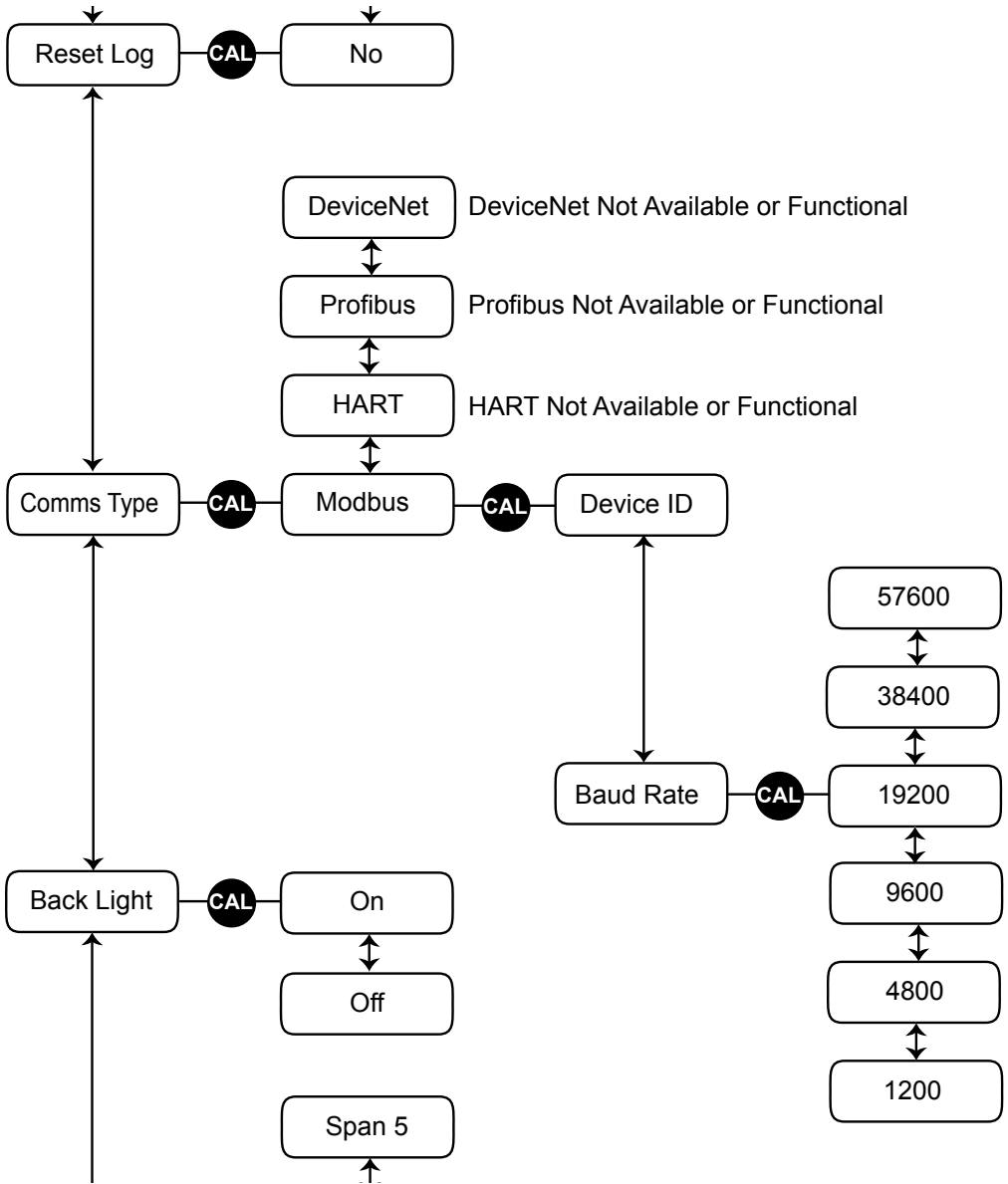

Software Flow Chart

Gladiator Admittance Smart Switch Series

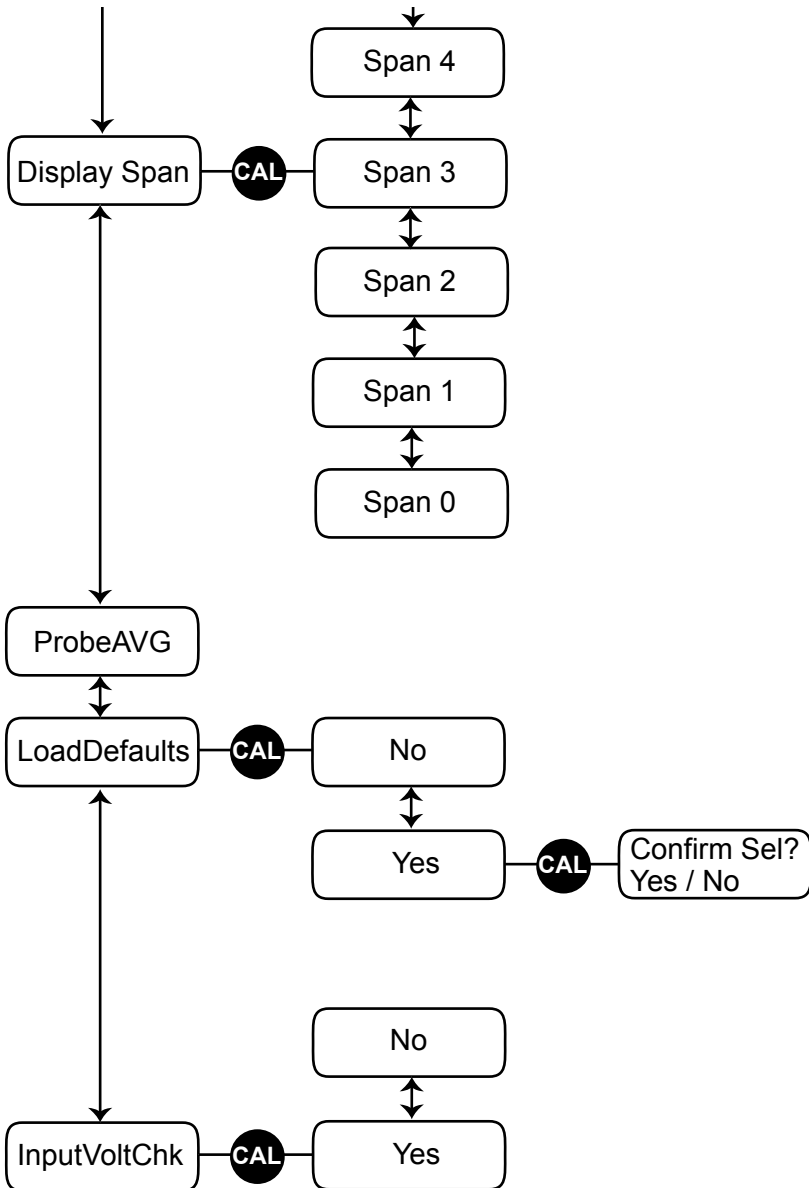



Remote Version

Operation Setup Check

After final adjustment it is advisable to check the performance of the probe relative to your entered settings.

Ensure there is no mounting influence.

- When calibrating the mounting of the unit, there should be no product within at least 500mm of the probe. After calibrating the unit the Sensor Value (%) should read approximately 0.0% with no product near or touching the probe.
- Allow infeed to occur and note the Sensor Value (%) change (if there is any) - as the level gets closer to the probe the Sensor Value (%) number will increase and continue to increase as the product gets closer to, touches and covers the probe.
- The Gladiator is capable of switching repeatably and reliably without product contacting the probe for a wide variety of materials. Some very low dielectric materials may need to touch the probe to be detected.
- The Sensor Value (%) will reach its maximum after the probe is covered - but the Switch Point can be set at any value less than the maximum. It is recommended to select the set point more than 10% below the maximum value seen with material touching the probe.

- For instance the following readings may occur during filling:

Sensor Value (%)	
Before filling	0.0%
Filling starts	0.7%
Filling continue	4.9%
Filling continue	27.5%
Material approaching probe	48.5%
Material contacts probe	96.5%
Material covers probe	285.7%

A. You may choose to leave the Switch Point at the default 50%. The Gladiator will switch reliably without contact of the material to the probe.

B. You may choose to adjust the Switch Point to 100% to switch when the product contacts the probe.

- By default the Switch Off % is set at 1/2 of the Switch Point. You may wish to adjust this to a higher or lower number. This is adjustable in the Advanced Menu by selecting Switch Mode - Manual. You can then manually select your Switch On and Switch Off values.
- In general, you should not choose the Max Sensor % (Max) value nor the Min Sensor % (Min) value as the Switch Point.
- If possible, always have the Switch On % at a value of at least 10% less than the Max Sensor % (Max) value and Switch Off at least 10% more than the Min Sensor % (Min).
- If the % change on the display is too small then the Display Span parameter in the Advanced menu can expand the display resolution (select a larger number - smaller raw range) and vice versa. Changing the Display Span will change Switch Point value.



Integral Probe Version

AS2100 Gladiator Admittance Switch - Integral Probe

Power Supply

- B 12-30 VDC
- U 12-30VDC and 90-260VAC

Output Options

- S 1 x SPDT Relay
- D 1 x DPDT Relay

Housing

- S Powder Coated Aluminium
- C 316L Stainless Steel

Guard Length (excludes 100mm ground length)

- 1 150 mm (5.9")

Temperature

- 1 Max. 80°C (176°F)
- 2 Max. 150°C (302°F)
- 3 Max. 250°C (482°F)
- 4 Max. 450°C (842°F) (1.5" mounting thread only)

Probe Type

- 1 316L rod
- 2 Teflon Insulated 316L rod
- 3 Cable

Mounting

- TN07 3/4" NPT Thread
- TB07 3/4" BSP Thread
- TN10 1" NPT Thread
- TB10 1" BSP Thread
- TN15 1.5" NPT Thread
- TB15 1.5" BSP Thread
- FA2 2" ANSI SS Flange (Class 150)
- FD2 DIN50 SS Flange (PN 40)

Approvals (intrinsically safe barriers may be required, consult safety instructions)

- X Not Required
- A20A (Open Vessel) ATEX Grp II Cat 1/2 D Ex iaD A20 IP65 T100°C for Tamb -20°C to 80°C
- A20 (Closed Vessel - Internal) ATEX Grp II Cat 1/2 D Ex iaD A20 IP65 T100°C
- (Closed Vessel - External) ATEX Grp II Cat 1/2 D Ex iaD A20 IP65 T100°C for Tamb -20°C to 80°C
- i20A (Open Vessel) IECEx Zone 20 (Ex iaD tD A20 IP65 T100°C Ta -20°C to 80°C)
- i20 (Closed Vessel - Internal) IECEx Zone 20 (Ex iaD 20 IP65 T100°C Ta -20°C to 80°C)
- (Closed Vessel - External) IECEx Zone 21 (Ex iaD A21 IP65 T100°C Ta -20°C to 80°C)
- A22 ATEX Grp II Cat 3 GD T75°C IP67 Tamb -40°C to 65°C

(P)Probe² (C)Cable Length

- P10 100mm (4")
- P30 300mm (11.8")
- P50 500mm (19.6")
- P100 1000mm (39.3")
- C100 1000mm (39.3")
- C200 2000mm (78.7")
- C300 3000mm (118.1")
- C500 5000mm (196.9")

AS2100 B S S 1 1 1 TB15 X P30

²Custom lengths available. Consult Factory

Part Numbering

Gladiator Admittance Smart Switch Series



Remote Probe Version

Remote Amplifier

GSA Remote Gladiator System Amplifier

Housing

S Polycarbonate

Power Supply

B 12-30VDC

C 36-60VDC

U 12-30VDC and 90-260VAC

Output Options (inc. Modbus)

S Switch only, 1 level relay, 1 failsafe relay

Approvals

X Not Required

A22 ATEX Grp II Cat 3 GD T75°C IP67

Tamb -40°C to 65°C

GSA S U S

² Approvals Table
A20A (Open Vessel)
ATEX Grp II Cat 1/2 D Ex iaD A20 IP65 T100°C for Tamb -20°C to 80°C
A20 (Closed Vessel)
(Internal of Vessel) ATEX Grp II Cat 1/2 D Ex iaD A20 IP65 T100°C
(External of Vessel) ATEX Grp II Cat 1/2 D Ex iaD A20 IP65 T100°C for Tamb -20°C to 80°C
i20A (Open Vessel)
IECEX Zone 20 (Ex iaD tD A20 IP65 T100°C Ta -20°C to 80°C)
i20 (Closed Vessel)
(Internal of Vessel) IECEX Zone 20 (Ex iaD 20 IP65 T100°C Ta -20°C to 80°C)
(External of Vessel)
IECEX Zone 21 (Ex iaD A21 IP65 T100°C Ta -20°C to 80°C
A22
ATEX Grp II Cat 3 GD T75°C IP67 Tamb -40°C to 65°C

Some Approvals may require Intrinsically Safe Barriers.
Consult Safety Instructions for further information

Remote Probe

AS2200 Remote Gladiator Admittance Probe

Housing

S Powder Coated Aluminium

C 316L Stainless Steel

Guard Length (excludes 100mm ground length)

1 150 mm (5.9")

Temperature

1 Max. 80°C (176°F)

2 Max. 150°C (302°F)

3 Max. 250°C (482°F)

4 Max. 450°C (842°F) (1.5" mounting thread only)

Probe Type

1 316L rod

2 Teflon Insulated 316L rod

3 Cable

Mounting

TN07 3/4" NPT Thread

TB07 3/4" BSP Thread

TN10 1" NPT Thread

TB10 1" BSP Thread

TN15 1.5" NPT Thread

TB15 1.5" BSP Thread

FA2 2" ANSI SS Flange (Class 150)

FD2 DIN50 SS Flange (PN 40)

Approvals (see Approvals Table)²

X Not Required

A20

A20A

i20

i20A

A22

(P)Probe³ (C)Cable Length

P10 100mm (4")

P30 300mm (11.8")

P50 500mm (19.6")

P100 1000mm (39.3")

C100 1000mm (39.3")

C200 2000mm (78.7")

C300 3000mm (118.1")

C500 5000mm (196.9")

AS2200 S 1 1 1 TB15 X P30

³Custom lengths available. Consult Factory





Pump Protection Version

AS2100 Gladiator Admittance Switch - Integral Probe

Power Supply

- B 12-30 VDC
- U 12-30VDC and 90-260VAC

Output Options

- S 1 x SPDT Relay
- D 1 x DPDT Relay

Housing

- S Powder Coated Aluminium
- C 316L Stainless Steel

Guard Length

- 2 Short Guard

Temperature

- 1 Max. 80°C (176°F)
- 2 Max. 150°C (302°F)
- 3 Max. 250°C (482°F)

Probe Type

- 1 316L rod

Mounting

- TN05 1/2" NPT Thread
- TB05 1/2" BSP Thread

Approvals (see Approvals Table)²

- X Not Required
- A20A
- A20
- i20A
- i20
- A22

(P)Probe

- P05 50mm

²Approvals Table

A20A (Open Vessel)
ATEX Grp II Cat 1/2 D Ex iaD A20 IP65 T100°C for Tamb -20°C to 80°C
A20 (Closed Vessel)
(Internal of Vessel) ATEX Grp II Cat 1/2 D Ex iaD A20 IP65 T100°C
(External of Vessel) ATEX Grp II Cat 1/2 D Ex iaD A20 IP65 T100°C for Tamb -20°C to 80°C
i20A (Open Vessel)
IECEX Zone 20 (Ex iaD iD A20 IP65 T100°C Ta -20°C to 80°C)
i20 (Closed Vessel)
(Internal of Vessel) IECEX Zone 20 (Ex iaD 20 IP65 T100°C Ta -20°C to 80°C)
(External of Vessel)
IECEX Zone 21 (Ex iaD A21 IP65 T100°C Ta -20°C to 80°C)
A22
ATEX Grp II Cat 3 GD T75°C IP67 Tamb -40°C to 65°C

Some Approvals may require Intrinsically Safe Barriers.
Consult Safety Instructions for further information

AS2100 B S S 1 1 1 TB05 X P05

Specifications

Gladiator Admittance Smart Switch Series



Operating Voltage

- 12 - 30VDC (residual ripple no greater than 100mV)
- 80 - 260VAC 50/60Hz.
- 36-60VDC

Power Consumption

- <0.8W @ 24VDC
- <6W @ 48VDC
- <5VA @ 240VAC
- <3VA @ 115VAC

Communications

- GosHawk, Modbus.

Relay Output: (1) Integral (2) Remote

- Remote: 2 x Form 'C' (SPDT) contacts, rated 5A at 240Vac resistive
- Integral: 1 x DPDT or 1 x SPDT rated 5A at 240Vac resistive
- Remote failsafe test facility for one relay (SPDT only).

Measurement Range

- 0.2pF - 100nF.

Resolution

- 0.01 pF .

Electronic Accuracy

- 0.05 pF.

Stability

- 0.01% / °C.

Operating Temperature

- Remote electronics -40°C (-40°F) to 80°C (176°F)
- Integral Probe -40°C (-40°F) to 450°C (842°F)*
- Remote Probe -40°C (-40°F) to 450°C (842°F)*.

Probe/Amplifier Separation

- Up to 500m (1640ft) using specified extension cable.

Cable Type Between Amplifier and Probe

- 4 conductor shielded twisted pair instrument cable
- Conductor size dependent on cable length
- BELDEN 3084A, DEKORON or equivalent
- Max: BELDEN 3084A = 500m (1640 ft)
- Max: DEKORON IED183AA002 = 350m (1150ft).

Maximum Operating Pressure

- 10 BAR at 120°C.

Display (Remote version only)

- 2 line x 12 character alphanumeric LCD
- Backlight standard.

Memory - Remote

- Non-Volatile (No backup battery required)
- >10 years data retention.

Enclosure Sealing

- Integral Probe IP67
- Remote Electronics IP65 (NEMA 4x)
- Remote Probe IP67.

Cable Entries

BSP process mounting

- 2 x M20 glands

NPT process mounting

- 2 x 3/4" NPTF threaded adaptors

Remote

- 3 x 20mm (0.8"), 1 x 16mm (0.6") knock outs.

Mounting

- 1/2" NPT or BSP Thread
- 3/4" NPT or BSP Thread
- 1" NPT or BSP Thread
- 1.5" NPT or BSP Thread
- 50mm (2") Flange (ANSI, DIN or JIS patterns available).

Remote Test Input

- Press to test (used to check for malfunction of unit from remote position, PLC, SCADA etc).

Dielectric Constants Table

Gladiator Admittance Smart Switch Series



Material	Dielectric Constant	Material	Dielectric Constant	Material	Dielectric Constant	Material	Dielectric Constant
Acetal	3.6	Castor Oil	2.6	Glycerine	47.0	Palmitic Acid	2.3
Acetic Acid	6.1	Camphene	2.3	Glycerol	43.0	Pentane	1.8
Acetone	17.7	Cement	2.1	Glycol	35.6	Phenol	9.9
Acetyl Acetone	23.1	Chloracetic acid	12.3	Heptane	1.9	Phenol Acetate	6.9
Acetyl Bromide	16.5	Chlorine	2.0	Heptanoic Acid	2.5	Phosgene	4.7
Allyl Alcohol	21.0	Chloroform	5.5	Hexane	1.9	Phosphorus	4.1
Allyl Bromide	7.0	Creosol	10.6	Hydrogen Bromide	3.8	Polyethylene chips	1.3
Allyl Chloride	8.2	Cyclohexane	2.0	Hydrogen Chloride	4.6	Polyethylene powder	1.4
Allyl Iodide	6.1	Deuterium	1.3	Hydrogen Cyanide	95.4	Propyl Acetate	6.3
Ammonia	15.5	Deuterium Oxide	78.3	Hydrogen Fluoride	84.0	Propyl Alcohol	21.8
Amyl Alcohol	11.2	Dichloracetone	14.0	Hydrogen Iodide	2.9	Propyl Benzene	2.4
Amyl Bromide	6.3	Dichlorobenzene	2.8	Hydrogen Peroxide	84.2	Pyridine	12.5
Amyl Chloride	6.6	Dichloroethane	16.7	Hydrogen Sulfide	5.8	Reburned Lime	2.2
Amyl Ether	3.1	Diethyl Sulfide	7.2	Hydrazine	52.9	Sand (Dry)	4.8
Amyl Iodide	6.9	Dimethyl Ethyl	11.7	Iodine	118.0	Sodium Chloride	6.1
Amyl Nitrate	9.1	Dimethyl Sulfide	6.3	Isobutyl Alcohol	18.7	Sodium Oleate	2.7
Arsenic Tribromide	9.0	Dimethyl Sulfate	55.0	Kerosene	1.8	Succinic Acid	2.4
Arsenic Trichloride	12.4	Dowtherm	3.3	Lead Oleate	3.2	Sodium Chloride	6.1
Arsenic Triiodide	7.0	Ethanol	24.3	Lonone	10.0	Sulphur	3.4
Asphalt	2.65	Ethyl Acetate	6.4	Menthol	3.95	Sulphur Dioxide	17.6
Benzene	2.3	Ethyl Amyl Ether	4.0	Mesityl Oxide	15.4	Sulfuryl Chloride	10.0
Benzil	13.0	Ethyl Benzene	2.5	Methanol	33.6	Sulphur Trioxide	3.6
Benzoyl Chloride	22.1	Ethyl Benzoate	6.0	Methyl Alcohol	33.0	Teflon Powder	1.3
Benzyl Alcohol	13.0	Ethyl Cyclobutane	1.9	Methyl Ether	5.0	Teterabromethane	7.1
Benzyl Chloride	6.4	Ethylene Chloride	10.5	Methyl Ether Ketone	18.4	Thionyl Bromide	9.1
Boron Bromide	2.6	Ethylene Cyanide	58.3	Mineral Oil	2.1	Thionyl Chloride	9.3
Bromine	3.1	Ethylene Glycol	37.0	Naphthyl Ethyl Ether	3.2	Titanium Tetrachloride	2.8
Butane	1.4	Ethylene Oxide	13.9	Nitroethane	19.7	Toluene	2.4
Butyl Chloride	9.6	Ethyl Iodide	7.4	Nitromethane	39.4	Trichloro-xluene	6.9
N Butyl Iodide	6.1	Ethyl Nitrate	19.7	Octane	1.96	Trimethylbenzene	2.2
Iso Butyl Iodide	5.8	Ethyl Silicate	4.1	Octyl Alcohol	3.4	Trimethyl Borate	8.2
Cable Oil	2.2	Fly Ash	2.6	Octylene	4.1	Urethane	3.2
Camphene	2.7	Formic Acid	58.5	Oleic Acid	2.46	Valeric Acid	2.6
Carbon Dioxide	1.6	Freon 12	2.4	Oil, Olive	3.1	Vinyl Ether	3.9
Carbon Disulphide	2.6	Freon 11	3.1	Oil, Peanut	2.2	Water	80.0
Carbon Tetrachloride	2.2	Freon 113	2.6	Oil, Transformer	2.2	Xylene	2.4

All company or product names are registered trademarks or trademarks of their respective owners.

Hawk Measurement Systems (Head Office)

15 - 17 Maurice Court
Nunawading VIC 3131, AUSTRALIA
Phone: +61 3 9873 4750
Fax: +61 3 9873 4538
info@hawk.com.au

Hawk Measurement

96 Glenn Street
Lawrence, MA 01843, USA
Phone: +1 888 HAWKLEVEL (1-888-429-5538)
Phone: +1 978 304 3000
Fax: +1 978 304 1462
info@hawkmeasure.com

For more information and global representatives: www.hawkmeasure.com

