

A Higher Level of Performance



Manual

G1

Microwave Switch Series

Beam Blockage Detection

Circular Polarisation



For more information, please visit >

www.hawkmeasure.com

Table of Contents

G1 Microwave Switch Series



Contents

Overview	3	Cross-Talk Prevention	13
Principle of Operation	3	Cross-Talk Prevention - Integral Systems	13
Typical Uses	3	Wiring	13
Function	3	System Calibration	13
Features	3	Mounting / Installation	14
Primary Areas of Application	3	Weldment / Couplings and Windows	14
System Components / Dimensions	4	Waveguides	15
G1 Integral System	4	Mounting Example	15
Dimensions	4	General Requirements	16
Dimensions	5	Setup Procedure	17
Mounting Accessories	5	Typical Setup	19
MD Series Weldments and Windows	6	Modbus / Troubleshooting	20
Waveguides and Waveguide Accessories	7	Modbus Registers	20
Waveguides and Waveguide Accessories	8	Troubleshooting	20
Wiring & Indication	9	Part Numbers	21
System Connection	9	G1 Series	21
Functionality Layout	10	MA Series Mounting Accessories	21
Relay Functions	11	Waveguides & Waveguide Accessories	21
Test Switch Functions	12	Microwave Sequencer	21
G1R Receiver Test Switch Functions	12	MD Series Mounting Accessories - Kit	22
		MD Series Mounting Accessories - Parts	22
		Specifications	23

PROPRIETARY NOTICE

The information contained in this publication is derived in part from proprietary and patent data. This information has been prepared for the express purpose of assisting operating and maintenance personnel in the efficient use of the instrument described herein. Publication of this information does not convey any rights to use or reproduce it, or to use for any purpose other than in connection with the installation, operation and maintenance of the equipment described herein

WARNING

This instrument contains electronic components that are susceptible to damage by static electricity. Proper handling procedures must be observed during the removal, installation, or handling of internal circuit boards or devices:

Handling Procedure:

1. Power to unit must be removed prior to commencement of any work.
2. Personnel must be grounded, via wrist strap or other safe, suitable means, before any printed circuit board or other internal devices are installed, removed or adjusted.
3. Printed circuit boards must be transported in a conductive bag or other conductive container. Boards must not be removed from protective container until the immediate time of installation. Removed boards must be placed immediately in a protective container for transport, storage, or return to factory.

Overview

G1 Microwave Switch Series



Principle of Operation

A high power circular polarized Microwave pulse is emitted from the Sending unit to the Receiving unit in a transmission chain of approximately 100 pulses per second.

If the path between the Sender and Receiver is blocked by any object or material which absorbs or reflects microwave energy the Receiving unit will no longer detect the complete transmission chain and indicate via Relay for automatic indication and process control requirements.

Typical Uses

- Blocked chute detection
- Nucleonic switch replacement
- High level alarm / Low level alarm
- Truck / machine detection.

Primary Areas of Application

- Asphalt
- Brewing
- Cement
- Chemical
- Dairy
- Edible oil
- Fertilizer
- Food & Beverage
- Glass
- Mining & Metals
- Oil & Gas
- Packaging
- Paint
- Paper
- Pharmaceutical
- Plastics
- Power Generation
- Refining
- Semiconductor
- Sugar
- Textile
- Water & Wastewater.

Function

The Gladiator Microwave Switch can be used for blockage detection, barrier detection, machine detection, collision detection or protection and point level measurement, and detection of objects or material between two points.

Features

- State of the art circular polarisation
- Simple sensitivity adjustment and calibration
- IECEx ta tb IIIC T* Da Db
- Theoretical ranges up to 300m (984 ft)
- Simple '1-minute' setup application pre-sets
- Relay outputs: Integral (1 + failsafe)
- Remote test function
- Adjustable ON and OFF delays (0-20 sec)
- Remote 3G Hawklink connection option
- Bright visual status indication on sensors
- Independent housing alignment after mounting sensor.

***Consult Safety Instructions**



System Components / Dimensions

G1 Microwave Switch Series



G1 Integral System

The G1 Integral System consists of 2 units. One Sender (G1S) and one Receiver (G1R)

G1S



G1R



Dimensions

G1S / G1R

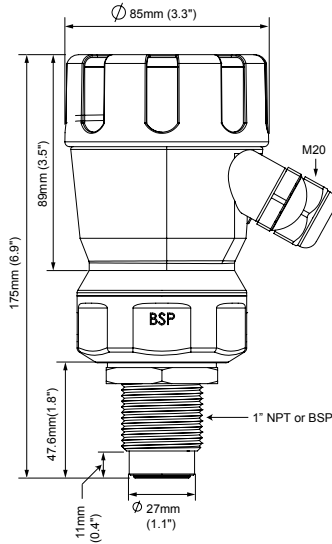

Dimensions

G1 Microwave Switch Series



Mounting Accessories

MA1

(Consists of MA1-WC and MA1-UW)

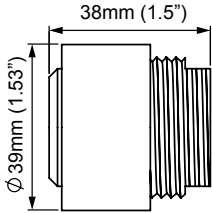

MA1-WC

Weldment / Coupling

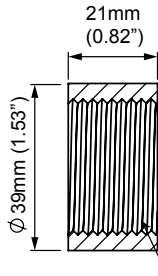

1" BSP
internal thread

MA1-UW

UHMW Window

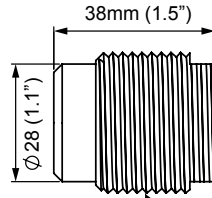

1" BSP
external thread

MA2

(Consists of MA2-WC and MA2-UW)

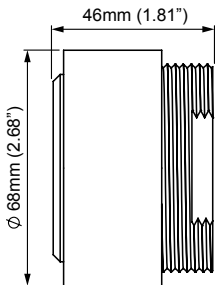

MA2-WC

Weldment / Coupling

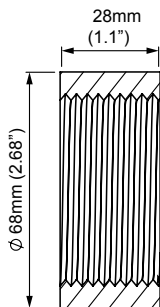

2" BSP
internal thread

MA2-UW

UHMW Window

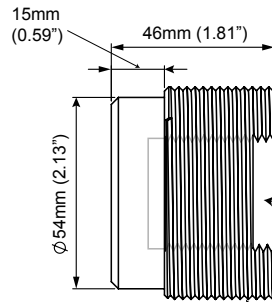

1" BSP/NPT
internal thread

2" BSP
external thread

Dimensions

G1 Microwave Switch Series



MD Series Weldments and Windows

Weldment with UHMW or PTFE Windows

The Weldment is welded to the vessel. The Window locks into the weldment using a locking ring.

For Approval Option 2D Installations. Consult Safety Instructions for critical details.

UHMW / PTFE Window

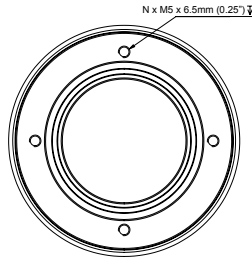
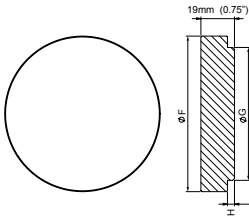

Weldment

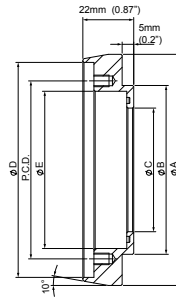

Assembled Piece



Part No ¹ .	Window Material	A		B		C		D		E		P.C.D		No. Holes
		mm	in	mm	in	mm	in	mm	in	mm	in	mm	in	
MD1-X	UHMW	75	3.0	48	1.9	29	1.1	68	2.7	43	1.7	52	2.0	4
MD2-X	UHMW	100	3.9	73	2.9	54	2.1	93	3.7	68	2.7	77	3.0	4
MD3-X	UHMW	122	4.8	93	3.7	77	3.0	115	4.5	90	3.5	99	3.9	4
MD6-X	PTFE	122	4.8	93	3.7	77	3.0	115	4.5	90	3.5	99	3.9	4

¹X = Weldment Material Selection

Part No ¹ .	Window Material	F		G		H		P.C.D		No. Holes
		mm	in	mm	in	mm	in	mm	in	
MD1-X	UHMW	43	1.7	28	1.1	4	1.6	52	2.0	4
MD2-X	UHMW	68	2.7	53	2.1	4	1.6	77	3.0	4
MD3-X	UHMW	89	3.5	76	3.0	4	1.6	99	3.9	4
MD6-X	PTFE	89	3.5	76	3.0	4	1.6	99	3.9	4

¹X = Weldment Material Selection

Dimensions

G1 Microwave Switch Series



Waveguides and Waveguide Accessories

MA-WG-04

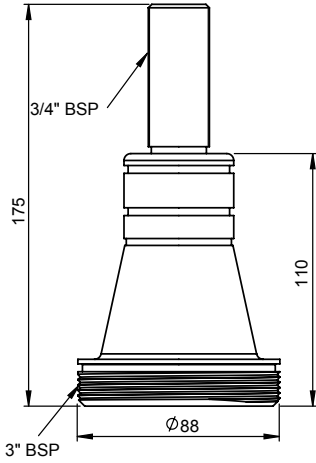

MA-WG-04 with MA-WG14

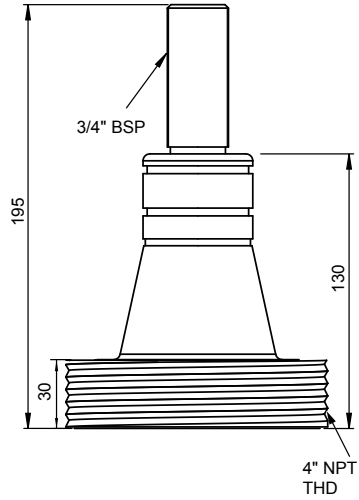

MA-WG-03

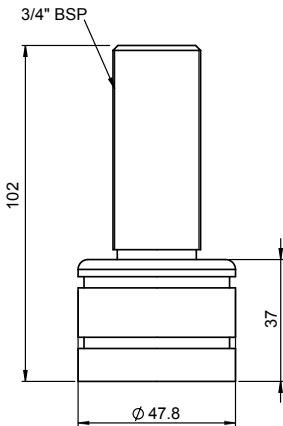

MA-WG-01

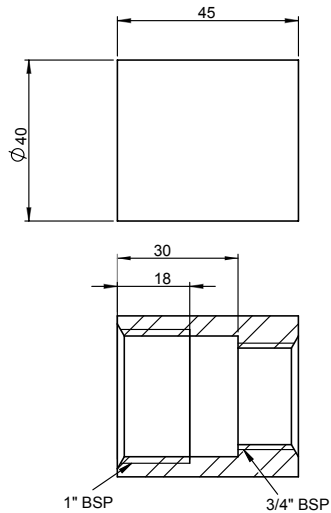

Dimensions

G1 Microwave Switch Series



Waveguides and Waveguide Accessories

MA-WG12-L=xxx

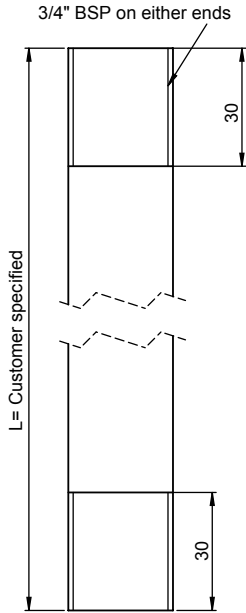

MA-WG-02

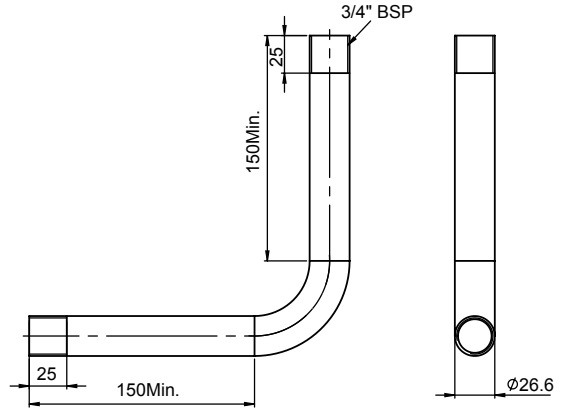

MA-WG-13

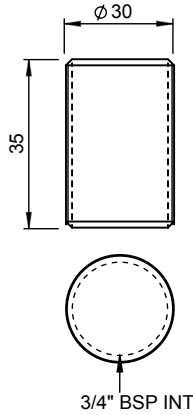

MA-WG12

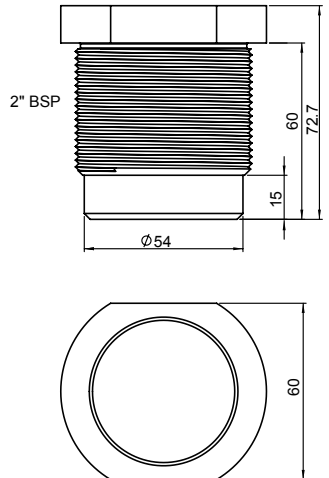

MA-WG11

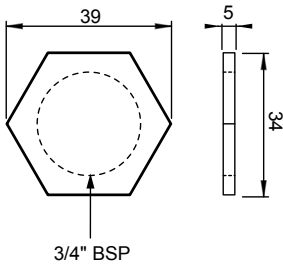

Wiring & Indication

G1 Microwave Switch Series



System Connection

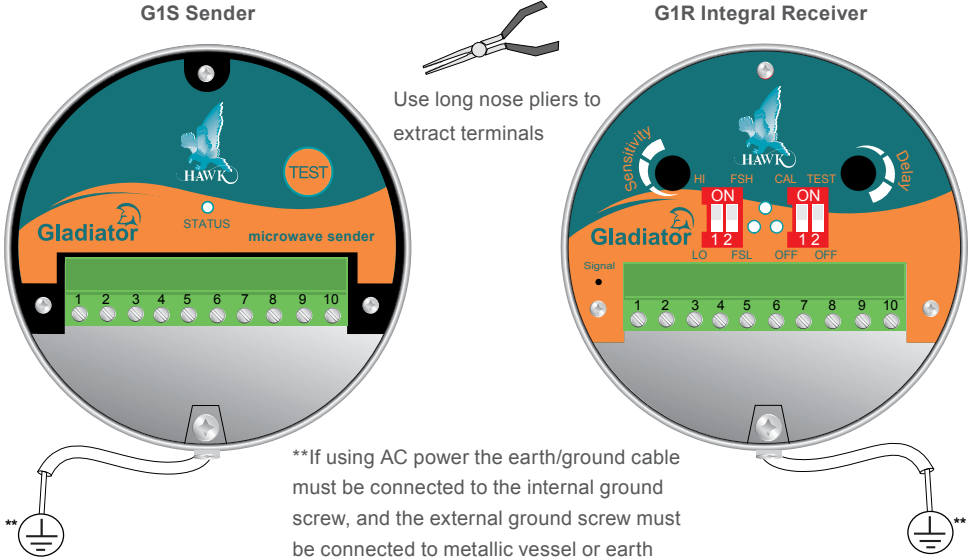

SENDER TERMINAL LAYOUT

						DC-IN		AC-IN	
1.	2.	3.	4.	5.	6.	7.	8.	9.	10.
						+	-	N	L1
						12-30VDC		80-260VAC	

Terminals 1, 2, 3, 4, 5, 6 not used

RECEIVER TERMINAL LAYOUT

RELAY				COMMS		DC-IN		AC-IN	
1.	2.	3.	4.	5.	6.	7.	8.	9.	10.
NC	COM	NO	Test	A	B	+	-	N	L1
				RS 485		12-30VDC		80-260VAC	
				Modbus					
				D0 D1					

Sender

Status LED

- Green when powered
- Blinks while working correctly
- Solid while not transmitting

TEST button

Press and hold to test level relay action

Receiver

Status LED

- Green when powered
- High illumination = strong signal
- Low illumination = weak signal

Signal Contact

Signal can be read with voltmeter across Signal contact point and earth screw (or other ground reference)
2.4-2.5V is full signal. 0V is no signal





Functionality Layout

G1S Sender

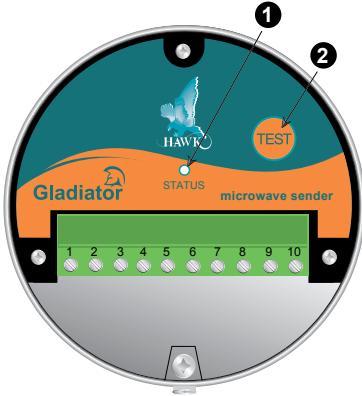

G1R Receiver

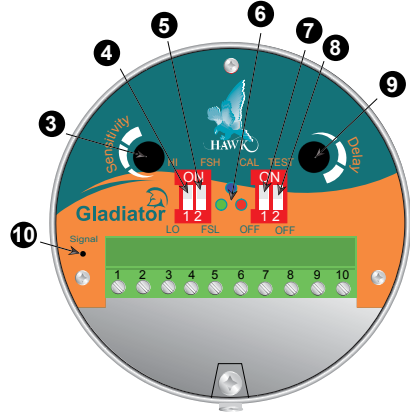

(1) Sender status LED

- Blinks while working correctly.
- Solid while not transmitting.

(2) TEST button

- Press and hold to test level relay action.

(3) Sensitivity dial

- Turn clockwise for switching in clean environments and object detection.
- Turn counter-clockwise for difficult applications, dusty/wet environments.

(4) Hi / Lo switch

- Hi mode for clean environments and object detection.
- Lo mode for difficult applications, dusty/wet environments.

(5) FSH / FSL switch

- FSH relay normally closed.
- FSL relay normally open.

(6) Receiver status LEDs

- Green - High illumination for good signal, Low illumination for weak signal.
- Red - Relay indication. Illuminated when closed.
- Blue - Cal mount indication - flashes during Cal mount, will stay illuminated if Cal mount fails.

(7) Cal Mount switch

- Cal mount conducts the automatic setup routine for the system. Perform Cal mount for all new installations, and after adjusting either Sensitivity pot or Hi/Lo switch.
- Switch up to initiate Cal mount, wait several seconds, then switch back down. Unit will automatically complete Cal mount routine.

(8) Test switch

- Can be used for a failsafe / test relay.

(9) Delay pot

- Rotate clockwise to increase Relay on/off delay time.

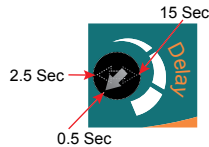

(10) Signal contact











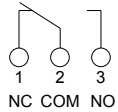

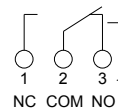
- Signal can be read with voltmeter across Signal contact point and earth screw (or other ground reference). 2.4-2.5V is full signal. 0V is no signal.

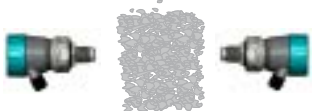
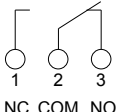
Relay Functions

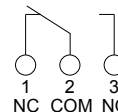
G1 Microwave Switch Series

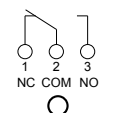

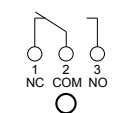
Relay Functions

	Relay Action		
	FailSafe Low FSL	FailSafe High FSH	
<p>State 1 Clear path</p> 	 <p>1 2 3 NC COM NO</p> 	 <p>1 2 3 NC COM NO</p> 	<p>Relay Status</p> <p>G1R terminal numbers</p> <p>Red LED Status</p>
<p>State 2 Blocked path</p> 	 <p>1 2 3 NC COM NO</p> 	 <p>1 2 3 NC COM NO</p> 	
<p>Power Failure</p>	 <p>1 2 3 NC COM NO</p> 	 <p>1 2 3 NC COM NO</p> 	



G1R Receiver Test Switch Functions

The test terminal has two potential modes of operation.

Test Input Mode

Test Switch: ON

Test terminal acts as an input for remote testing of the instrument's switching function. Used to check for malfunction of unit from a remote position, PLC, SCADA etc.

Test Input from PLC/SCADA/DCS Digital Output

Receiver Terminal Block

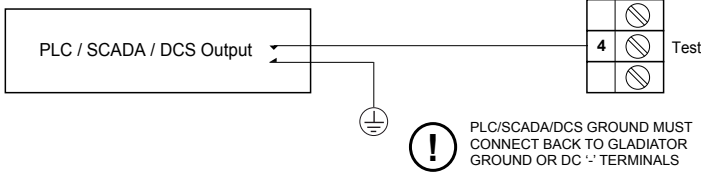

Operator Controlled Press To Test

Receiver Terminal Block

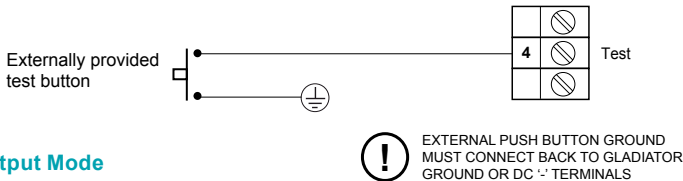

Failsafe Output Mode

Test Switch: OFF

Test terminal will provide an output which is able to switch an external failsafe relay or PLC/SCADA/DCS input. During normal system operation this terminal will internally switch a solid state (transistor) output to ground (or DC '-'). If power fails or an internal system failure occurs, the terminal will act as an open circuit.

To switch an external relay

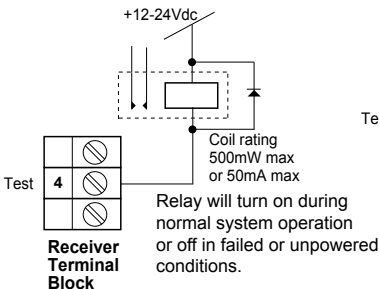

To a PLC input

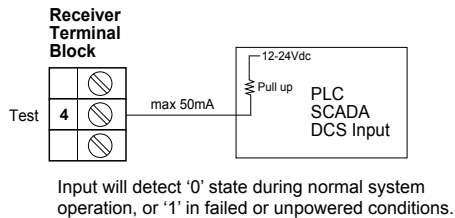

Cross-Talk Prevention

G1 Microwave Switch Series



Cross-Talk Prevention - Integral Systems

The GMSEQ Microwave sequencer will operate as the pulse control (Master) for up to 4 Integral systems. Each connected Microwave system will operate as a Slave. The Sequencer will pulse control from CH1 to CH2 to CH3 to CH4 then return to CH1.

More than one system can be connected to each channel, note that each system connected to the same channel will be part of the same slave 'sequence' in the pulsing.

First, the Sequencer On and Off time (in Quickset menu of Sequencer) must be set to the following values.

- On time – 2000µs
- Off time – 2000µs

Wiring

Please note units still require external power source.

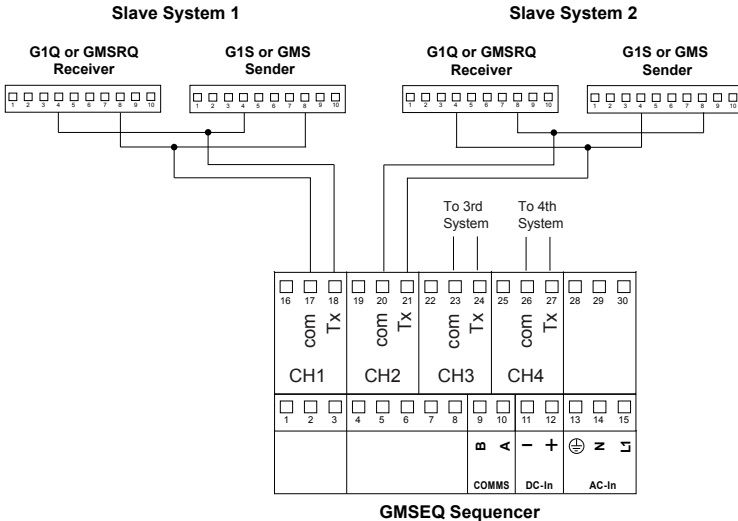

System Calibration

To set up the Microwave systems, perform as per below.

1. Complete wiring of all units to be used in the Sequenced network and apply power.
2. Run setup / calibration as per normal installation instructions.





Weldment / Couplings and Windows

The weldment / couplings are designed to be welded into an appropriately sized hole in the vessel or application wall. A matching UHMW high wear window is then threaded into the weldment / coupling to act as a seal for the application. For Approval Option 2D Installations the Window is secured using a Locking Ring. See MD Series Windows and Weldments for further information.

This typical installation isolates the Microwave hardware from coming into contact with any damaging materials and allows simple maintenance or replacement of units without having to unseal the process / application.

The Microwave transmission will pass directly through plastics to measure the material in the process.

MA2 - 2" Weldment / coupling with UHMW windows

Isolated from process with Weldment / Coupling and window

Mount maximum 100mm (4") back from Window

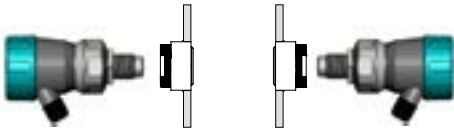

MA1 - 1" Weldment / coupling with UHMW window

Isolated from process with Weldment / Coupling and window

Mount maximum 100mm (4") back from Window

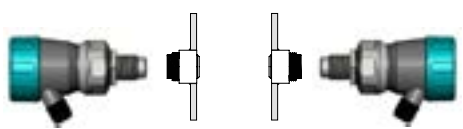

Isolated from process with Weldment / Coupling and window

Mounted to MA2-UW threaded window

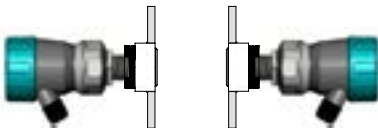

Sensing element within process

Mounted to MA1-WC threaded weldment / coupling

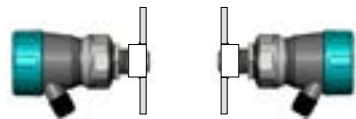



Waveguides

System with Waveguide extensions for remote mounting / signal transmission.

Waveguides can be used for difficult to access areas or to isolate the electronics from high temperature or non-compatible processes.

For further information on Waveguides see G1 Waveguide parts and assembly guide document available at <http://www.hawkmeasure.com>

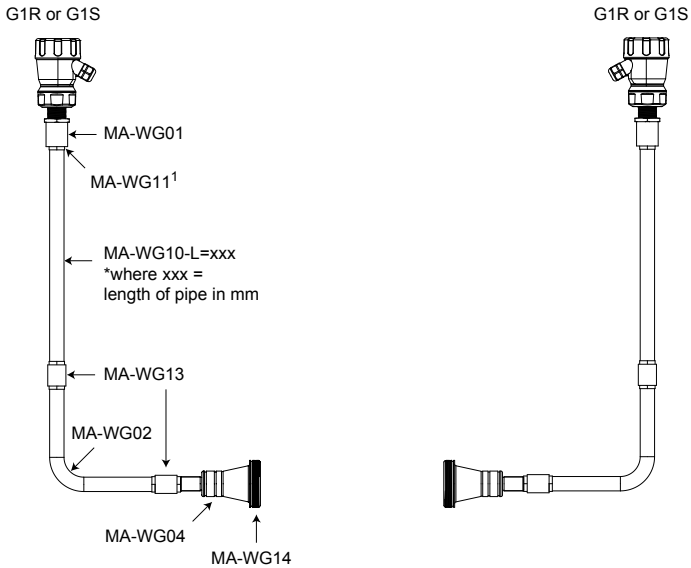

¹Displayed drawing includes qty 5 of MA-WG11 locking nut per side

Mounting Example

System with Waveguide extensions with MA2-WC-SS window and weldment/coupling application seal.

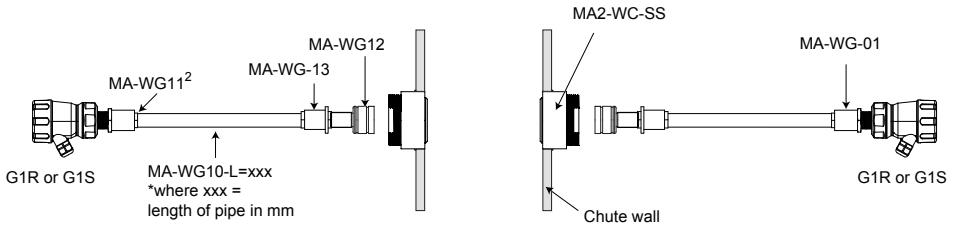

²Displayed drawing includes qty 3 of MA-WG11 locking nut per side



General Requirements

1. When looking for a mounting location it is important to locate and mount the interior of the window/sensor face for each unit flush with the vessel wall and where minimal build-up will occur.

For chute type applications the maximum recommended distance between the Sensor and the chute / window is 100mm (4"). Use Waveguides if electronics cannot be mounted to this requirement.

A cavity or tubed mount in the vessel where the sensor is mounted may fill with process material and will result in a 'plug' forming in front of the beam path resulting in unwanted false trips or unit performance issues.

2. Microwave energy cannot penetrate through steel linings or other conductive linings. You must cut a viewing hole and use an appropriate windowed weldment.

3. For high vibration applications, it is necessary to isolate the electronics to keep them from long term damage. This is most often accomplished using 2" UHMW or Teflon windowed weldments in the vessel walls, and mounting the Microwave Sender and Receiver to a separate stable structure (I-beam, handrail) to isolate them from vibration.

4. For high temperature applications which exceed specified maximum temperature it is necessary to ensure that the sensors always remain below 65°C/150°F. Use waveguide assemblies to the high temperature area with the electronics in an appropriately rated area.

When mounting to monitor the level of a flowing product such as coal, ore or wood chips, position the microwave path out of the direct product flow stream. If at all possible, go behind the flow stream or well in front of it. This will minimise any possibility of unwanted trips due to abnormal product flow blocking the beam.

When using the system as a proximity switch such as truck detection the mounting arrangement is application dependent and must ensure proper operation even under worst case conditions.



Do not mount with cavity

Maximum distance between Sensor Face and chute: 100mm (4")

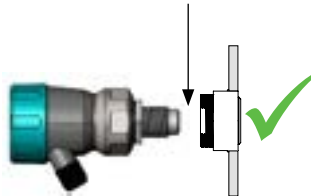

Mount behind flush Weldment / Coupling with Window

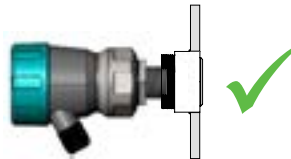

Mount behind flush Weldment / Coupling with Window

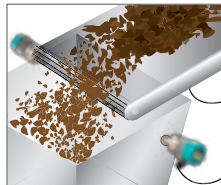

Mount away from main product flow

Setup Procedure

G1 Microwave Switch Series



Setup Procedure

1. Mount the units according to Mounting Requirements

1.1 If units are AC powered ensure proper grounding is connected to ground screw.

2. Powering the unit

The green status LED on the G1S Sender will blink while working correctly or be solid if not working correctly or not transmitting.

The green LED on the G1R Receiver will stay on permanently to indicate that power is on. The intensity of illumination of the light indicates signal strength (high intensity indicates good received signal).

3. Select the required relay action

The Relay can switch 'ON' (FSL) or 'OFF' (FSH) as the microwave beam is blocked. Set the relay action selection switch position depending on your requirements. FSH is recommended (ordinarily on/energized, switches off/ DEN during blocked conditions).

4. Select the Sensitivity

There are two adjustments controlling the sensitivity of the switch point:

4.1 The 'HI/LO' sensitivity switch is used as the primary sensitivity setting. Select LO sensitivity for Blocked Chute detection and if build-up is expected over sensors. Select HI sensitivity for clean environments, object detection and lighter/less absorptive material or targets. LO recommended for most applications.

4.2 The Sensitivity Dial

Turning the pot fully counter-clockwise factory recommended for blocked chute applications. If operating in HI mode set the pot to 12 o'clock. In this mode you can turning the pot clockwise to reduce the amount of beam blockage required for switching and vice versa.

G1S Sender



G1R Receiver

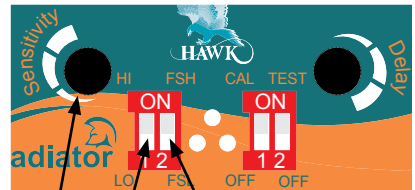

Sensitivity Dial
Sensitivity Switch
Relay Action Switch

Setup Procedure

G1 Microwave Switch Series



Setup Procedure

5. Select the relay time delay

Full anti clockwise is minimum (0.1 seconds). Full clockwise is maximum (20 seconds). Adjust as required allowing time to avoid possible nuisance trips. The selected delay will be used for both an ON delay and an OFF delay.

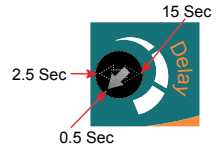

6. Perform a CAL mount

Do not proceed with this step unless there is clear path between the Sender and Receiver.

Switch CAL switch on the Receiver unit to ON position. The Blue LED will blink to indicate that mounting calibration is now in progress. Wait 5 seconds, then switch the mounting calibration switch to 'OFF' position.

The blue LED will switch off after successful calibration. If it stays on this indicates there was a calibration error. If this is the case please check that the path between sender and receiver is clear and alignment is correct. You may need to lower the Sensitivity setting. Try the calibration again. If mounting calibration was successful the blue LED should be off and the Green LED should be ON.

G1R Receiver

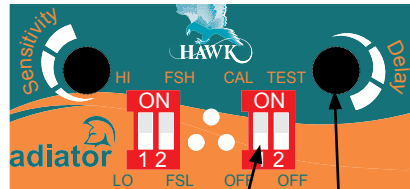

Cal Mount Switch Delay Pot

7. Relay test

If required block the Sender with a sample of the application material (note the units are capable of penetrating significant amounts build up). The green LED will dim when the Microwave beam begins to be blocked.

You can also press the 'TEST' button on the Sender to simulate the switch condition and trigger the relay action.

G1S Sender

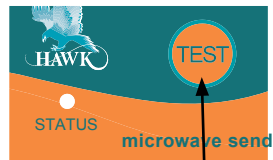

Relay Test Button

Typical Setup

G1 Microwave Switch Series

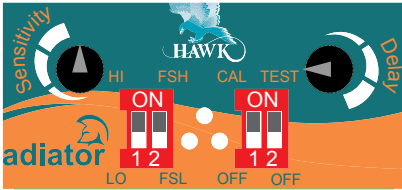
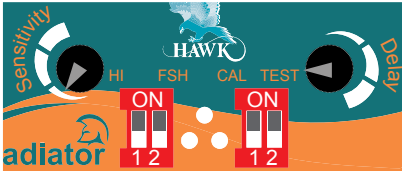
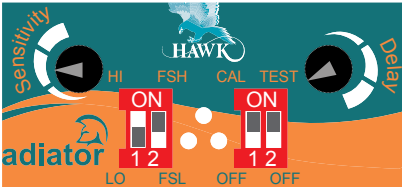
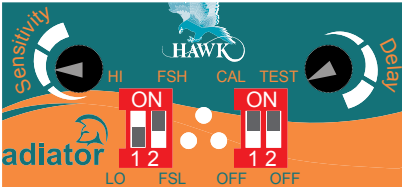
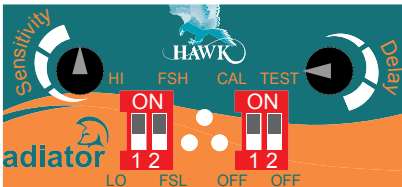

Typical Setups

Application	Setup
Chute Switch	 <p>Sensitivity Pot: 12 o'clock Sensitivity Switch: Lo Delay Pot: 9 o'clock</p>
Chute Switch (dirty conditions)	 <p>Sensitivity Pot: Fully counter-clockwise Sensitivity Switch: Lo Delay Pot: 9 o'clock</p>
Vehicle / Machine detection	 <p>Sensitivity Pot: 9 o'clock Sensitivity Switch: Hi Delay Pot: 8 o'clock</p>
Presence / Absence switch (clean environment)	 <p>Sensitivity Pot: 9 o'clock Sensitivity Switch: Hi Delay Pot: 8 o'clock</p>
Presence / Absence switch (dirty environment)	 <p>Sensitivity Pot: 12 o'clock Sensitivity Switch: Lo Delay Pot: 9 o'clock</p>



Modbus Registers

Comms A / B on the G1R unit (see Wiring page) can be used for Modbus networking

A = Modbus D0 (+) B = Modbus D1 (-)

Title	Address	Operation	Notes
Switch Value	122	Data Range 0-1000 0 = No blockage 1000 = Full blockage	Unit should read 0 after performing a Cal Mount. Increasing values can indicate application difficulties and provide warning for build up or maintenance checks.
Device ID	4	Data Range 1-255	Can be written or read. Value = ID
Restart Unit	100	Write Data 32768 to re-start unit	

Troubleshooting

Problem	Check
Unit Relay incorrectly tripping	Ensure no material build up is between the sensors. Ensure mounting is correct to mounting guidelines. Adjust unit settings to 'Lo' Sensitivity modes.
Unit Calibration fails (Blue LED stays illuminated)	Ensure no material build up is between the sensors. Ensure mounting is correct to mounting guidelines. Rotate Sensitivity pot anti clockwise. Adjust unit settings to 'Lo' Sensitivity modes. Bench test system with different Sender and Receiver. Replace faulted unit.
Relay flickers on/off (relay chatter)	Increase 'Delay' time. Reduce Sensitivity / Switch to Lo Sensitivity mode. Check for material build up in between the sensors. Ensure mounting is correct to mounting guidelines.
Switch / Relay testing	The units are designed to penetrate through generous amounts of material build up, small or thin objects may not be appropriate for Switch testing. Use the 'Test' button on the Sender unit to confirm unit Relay function is correct. The green LED on the Receiver (G1R) will dim when the signal is partially blocked. In some applications the unit beam spread may bounce around the target. Increase Sensitivity or use Waveguides to control the transmitted beam closer to the target or chute.
Relay does not switch when pressing 'Test' button during Switch testing	Bench test system with different Sender and Receiver. Replace faulted unit if required. Place a DC voltage Multimeter across Signal (+) contact and the (-) to an earth source on the G1R Receiver. This will read a DC voltage up to 2.5V while full signal is present on a healthy unit. When 'Test' button is pushed a low/no value (<0.010VDC) will be indicated. If while 'Test' button is pushed a signal is still present replace G1R Receiver.
Sender (G1S) green LED is permanently solid	This indicates the Sender is not transmitting. Ensure wiring is correct. Confirm incoming voltage is to correct specification. Replace with new Sender unit.
No LEDs illuminated on either unit	Ensure wiring is correct. Confirm power is present at the correct terminals and incoming voltage is to correct specification. Bench test system and replace any failed hardware.

Part Numbers

G1 Microwave Switch Series



G1 Series

Model	
G1S	Gladiator 1" Microwave Integral Sender
G1R	Gladiator 1" Microwave Integral Receiver, 1 Relay with Failsafe
G1Q	Gladiator 1" Microwave Integral Sequenced Receiver, 1 Relay with Failsafe (Requires GMSEQ Sequencer)
Electronics Housing (Sensor element is 316L with Teflon face)	
S	Powder Coated Aluminum
C	316L Stainless Steel

Power Supply

B	12-30VDC
U	12-30VDC and 80-260VAC

Mounting Thread

TB	1" BSP
TN	1" NPT

Approvals

X	Not Required
A22	ATEX Grp II Cat 3 GD T85°C IP67 Tamb -40°C to 70°C
2D	IECEX ta tb IIIC T* Da Db Tamb = -30 to +80C

G1S C B TB X

Microwave Sequencer

GMSEQ	Gladiator Microwave Sequencer
Power Supply	
B	12-30VDC
C	30-48VDC and 48-90VAC
U	12-30VDC and 90-260VAC

GMSEQ U

MA Series Mounting Accessories

MA

1	1" UHMW Window & mild steel weldment/coupling each
1-SS	1" UHMW Window & 316L stainless steel weldment/coupling each
1-UW	1" UHMW Window each
1-WC	1" mild steel weldment/coupling each
1-WC-SS	1" 316L stainless steel weldment/coupling each
2	2" UHMW Window & mild steel weldment/coupling each
2-SS	2" UHMW Window & 316L stainless steel weldment/coupling each
2-UW	2" UHMW Window each
2-WC	2" mild steel weldment/coupling each
2-WC-SS	2" 316L stainless steel weldment/coupling each

MA 2

*Additional mounting accessory variants and materials including high temperature ceramics are available.
See Gladiator Gen 3 Microwave datasheet available at www.hawkmeasure.com*

Waveguides & Waveguide Accessories

MA-WG

01	316L Threaded connector for Sender / Receiver
02	316L 90deg bend pipe (150mm + 150mm). Includes qty 2 of MA-WG11
03	316L 1-1/2" Wave guide horn. Includes Qty 1 MA-WG13
04	316L 3" Wave guide horn. Includes Qty 1 MA-WG13
10-L=1	316L Straight pipe extension 1L= length in mm. Includes qty 2 of MA-WG11
11	316L Locking nut
12	2" BSP Teflon plug with socket to match MA-WG03 horn
13	316L Pipe to pipe connector coupling
14	4" Teflon window to match MA-WG04 Horn. Fits into MA18 weldment

MA-WG 01

Part Numbers

G1 Microwave Switch Series



MD Series Mounting Accessories - Kit

For Approval Option 2D Installations. Consult Safety Instructions for critical details.

MD Mounting Accessories Kit

Window Facing Material

- 1 1" UHMW Window (-30°C to +75°C)
- 2 2" UHMW Window (-30°C to +75°C)
- 3 3" UHMW Window (-30°C to +75°C)
- 6 3" PTFE Window (-30°C to +200°C)

Weldment Material

- A SS304
- S SS316
- M Mild Steel

MD 3 - A

MD Series Mounting Accessories - Parts

For Approval Option 2D Installations. Consult Safety Instructions for critical details.

BASE Weldment Only

Weldment Size

- MD1 Matches MD1
- MD2 Matches MD2
- MD3 Matches MD3 & MD6

Material

- A SS304
- S SS316
- M Mild Steel

BASE - MD2 - A

WIN Window only

Window Facing Material

- MD1 UHMW for MD1 (-30°C to +75°C)
- MD2 UHMW for MD2 (-30°C to +75°C)
- MD3 UHMW for MD3 (-30°C to +75°C)
- MD6 PTFE for MD6 (-30°C to +200°C)

WIN - MD2

LRING Locking Ring Only

Ring Size

- MD1 Matches MD1
- MD2 Matches MD2
- MD3 Matches MD3 & MD6

Material

- A SS304
- S SS316
- M Mild Steel

LRING - MD2 - A

MD Series Part Combinatinos				
Full Kit ¹	Size	Window	Weldment ¹	Locking Ring ¹
MD1-X	1"	WIN-MD1	BASE-MD1-X	LRING-MD1-X
MD2-X	2"	WIN-MD2	BASE-MD2-X	LRING-MD2-X
MD3-X	3"	WIN-MD3	BASE-MD3-X	LRING-MD3-X
MD6-X	3"	WIN-MD6	BASE-MD3-X	LRING-MD3-X

¹X = Material Selection

Specifications

G1 Microwave Switch Series



Operating Voltage

- 12-30VDC (residual ripple no greater than 100mV)
- 80-260VAC.

Power Consumption

- <0.8W @ 24VDC
- <5VA @ 240VAC
- <3VA @ 115VAC.

Communications

- GosHawk, Modbus
- Multidrop mode can address 1-250 units over 4 wires.

Relay Output

- Form 'C' (SPDT) contacts, rated 5A at 240Vac resistive
- Remote fail-safe test facility for one relay.

Operating Temperature

- Integral Units -30°C (-20°F) to 65°C (150°F)*.
- *For higher temperature applications, remote waveguide mounting with appropriate windows is necessary.

Power Density

- Rated from emitter to receiver at approximately 20μW/cm²
- Complies with FCC Title Rules Part 15 (Beam Blockage)
- Caution sign posting not required.

Transmitted Signal

- Circular polarisation polarity
- Frequency: 10.525GHz
- Power: +14dBm / 25mW
- Sensitivity -88dBm
- Beam width 50°

Fail-Safe

- Selectable - presence or absence of material
- High level fail-safe: relay is activated when material is present.
- Low level fail-safe: relay is activated when no material is present.

Range

- Theoretical maximum range: 300m (984 ft)
- Recommended range (chutes) 15m
- Recommended range (object detection) 50m
- Minimum range under ideal conditions: 10cm (4 inches).

Note: Minimum ranges are dependent on application conductivity.

Maximum Operating Pressure

- 2 BAR.

Enclosure Sealing

- IP66/67.

Wetted Materials

- Sensing element housing: 316L stainless steel
- Sensing element face: Teflon.

Cable Entries

- Integral Units: 2 x M20 Glands / 3/4" NPTF threaded adapters.

Mounting

- 1" NTP
- 1" BSP.

Remote Test Input

- Press to test (used to check for malfunction of unit from remote position, PLC, SCADA etc).

Weight

- G1R 1kg
- G1S 1kg.

Approval

- IECEx Zone 20/21, Zone 21
- Ex ta tb IIIC T* Da Db Tamb = -30 to +80C
- IP66

**Consult Safety Instructions*

Specifications model dependent

A Higher Level of Performance

G1 Microwave Switch Series

HAWK, Since 1988

Hawk Measurement Systems Pty Ltd (HAWK) was established in 1988. It's founding members saw the universal requirement of various industries requiring improved process control and efficiency in their operations.

We Can Help

HAWK understands the difficulties customers face when seeking accurate level measurement. Every application is different, involving a multitude of environmental factors. This is where HAWK excels. Our aim is to ensure that customers not only feel comfortable with our technology, but also to ensure a consistent and reliable solution is in place for the long term. We believe that a combination of application and product expertise, as well as forward thinking and proactive support policies are the foundation of successful customer-supplier relationships.

Progressive Technical Support

HAWK believes that the future of the Level Measurement Industry revolves around the quality of pre and post sales - support. Our aim is for all sales & support staff to be product experts, and more importantly application experts making our customers applications as efficient and consistent as possible.

All company or product names are registered trademarks or trademarks of their respective owners.

Hawk Measurement Systems (Head Office)

15 - 17 Maurice Court
Nunawading VIC 3131, AUSTRALIA
Phone: +61 3 9873 4750
Fax: +61 3 9873 4538
info@hawk.com.au

For more information and global representatives: www.hawkmeasure.com

Remote Innovation

HAWK understands the need for immediate technical assistance.

The HAWKLink 3G communication device allows any computer with internet access and our free GosHawk diagnostic & calibration software; to dial in, calibrate, test, and check the performance of HAWK products. This innovative system allows our Global Support Team to assist with commissioning and after sales service of HAWK equipment worldwide. Measurement problems are addressed as they happen; not days or weeks later.

Knowledge Sharing

HAWK believes that knowledge sharing is key to creating long term relationships. Empowering our customers and our worldwide distribution network, whilst being available at all times to lend a helping hand, is the perfect recipe for long term solutions and relationships. HAWK openly extends an invitation to share our 25 plus years of level measurement experience, and ensure that your day to day processes are efficient, understood, and always working.

Hawk Measurement

96 Glenn Street
Lawrence, MA 01843, USA
Phone: +1 888 HAWKLEVEL (1-888-429-5538)
Phone: +1 978 304 3000
Fax: +1 978 304 1462
info@hawkmeasure.com