

A Higher Level of Performance



Data Sheet

Centurion Guided Radar

CGR Series



For more information, please visit >
www.hawkmeasure.com

Overview / Dimensions

Centurion Guided Radar



Principle of Operation

Guided-wave technology sends the radar pulse down a probe to measure either liquids or solids.

The pulse hits the surface and is reflected back up the probe to the sensor, where the transit time is translated into a distance using time of flight and time expansion.

The amplitude of the reflection depends on the dielectric constant of the product.



Function

The HAWK range of Guided Radar products are ideal for level measurement of liquids, solids, bulk materials, sludge, powders and granules to a distance of 18.5m (60ft).

This technology is not affected by pressure, temperature, viscosity, vacuum, foam, dust, changes in dielectric constant or coating of the probe.

Features

- IECEx Ex ia/d [ia Ga] IIC T6 Ga/Gb Tamb 60°C
- IECEx Ex ia tb [ia Da] IIIC T85C Da Db Tamb 60°C
- Up to 18.5m (60ft 8in) range
- Very short minimum range (150mm, 6")
- Simple setup
- Auto-Calibration to any dielectric ≥ 1.5
- Adjustable Sensitivity

Primary Areas of Application

- Chemicals
- Petrochemicals
- Cement
- Building Aggregates
- Mining / Minerals
- Food & Beverages
- Oil & Gas
- Pharmaceutical
- Pulp & Paper
- Wastewater

- Precise & continuous measurement
- 2 wire loop
- 4-20mA, HART
- Protection class IP66, Nema 4x
- Measures extremely low dielectric (1.5)
- Programmable fail safe mode

Wiring Terminal Compartment

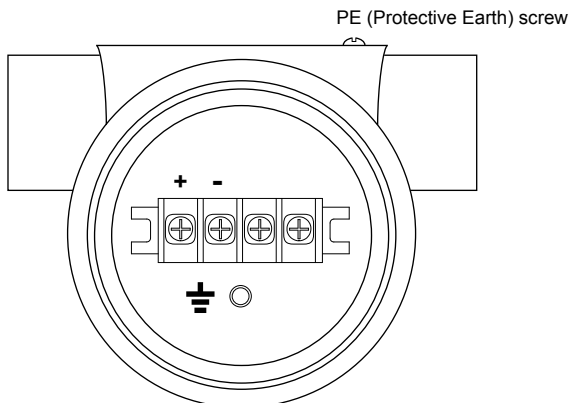

Dimensions - Reference

1	Housing
2	Barrier Gland / High Temp extension with Barrier Gland / End position with Barrier Gland
3	Threaded Connection / Flange
4	Probe Length

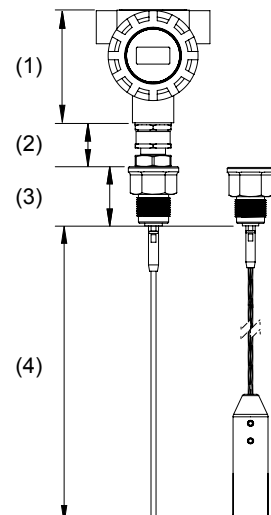



Dimensions Housing + Barrier Gland

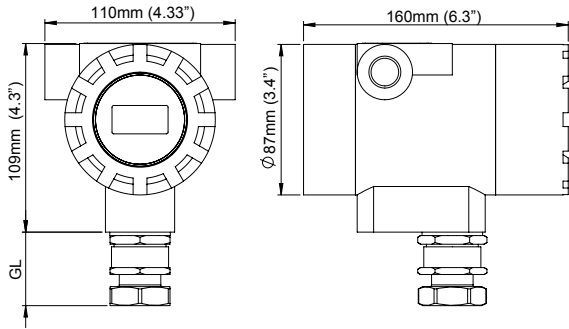

Barrier Gland Length (GL)			
Process Temp. Option*	Approval Option*	Length	
		mm	in
1	XX, 1D, 2D, 2A	55	2.2
2	XX, 1D, 2D, 2A	105	4.1

*Consult Part Numbering / Specifications for technical information

Housing with Process Temperature option '2'. Visual Reference only

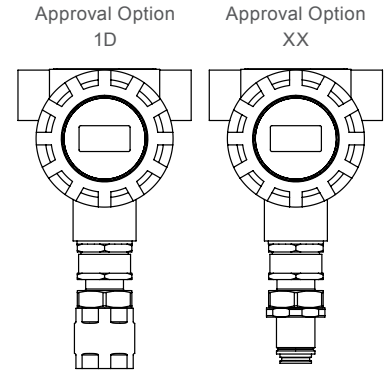

Dimensions - Probe Variants

A04 / A06 / A08 / J04 / J06 / J08

Threaded

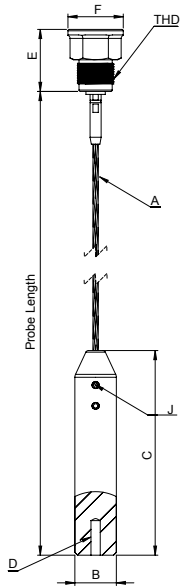

Welded Flange

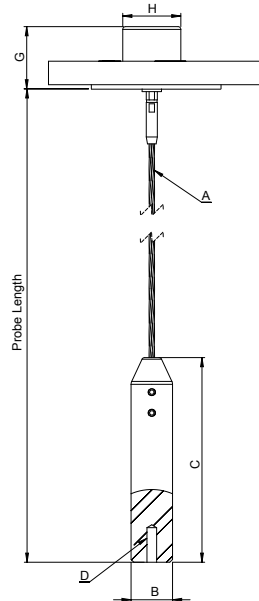

B04 / B06 / B08 / K04 / K06 / K08

Threaded

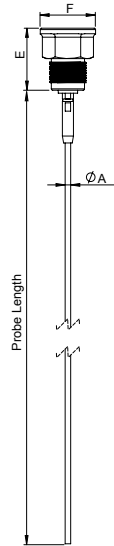

Welded Flange

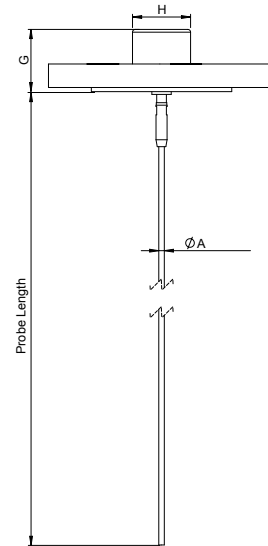

Probe / Cable Dimensions

Probe Type	THD BSP or NPT	A		B		C		E		F		D Internal Threads (A04, A06, A08 only)	J (Tightening Torque = 20Nm)	
		in.	mm	in.	mm	in.	mm	in.	mm	in.	mm		in.	Set Screw
A04, B04, J04, K04	3/4	4	0.16	22	0.9	120	4.7	45	1.8	40	1.6	M10x1.25, 24mm deep	3x M8x1.25x12	4mm
A06, B06, J04, K04	1	6	0.24	28	1.1	150	5.9	45	1.8	40	1.6	M10x1.25, 24mm deep	3x M8x1.25x12	4mm
A08, B08, J04, K04	1-1/2	8	0.31	36	1.4	200	7.8	72	2.8	64	2.5	M10x1.25, 24mm deep	3x M10x1.5x18	5mm
	Welded Flange	G		H										
		mm	in.	mm	in.									
A04, B04, J04, K04		45	1.8	42	1.6									
A08, B08, J04, K04		72	2.8	70	2.7									



Centurion Guided Radar System

Model

CGR2 2 wire Centurion Guided Radar

Communication

H 4-20mA with HART

Housing

- 1 Aluminium, Epoxy Painted
- 2 316L Stainless Steel

Gland Entry

- 1 1/2" NPT Cable gland entry
- 2 3/4" NPT Cable gland entry
- 3 M20 x 1.5 Cable gland entry
- 4 M25 x 1.5 Cable gland entry

Probe Type³

- A04 4mm flexible cable
- A06 6mm flexible cable
- A08 8mm flexible cable
- B04 4mm rigid probe
- B06 6mm rigid probe
- B08 8mm rigid probe
- J04 Detached 4mm flexible cable
- J06 Detached 6mm flexible cable
- J08 Detached 8mm flexible cable
- K04 Detached 4mm rigid probe
- K06 Detached 6mm rigid probe
- K08 Detached 8mm rigid probe

Probe variant / materials³

S 316L

Mounting³

- TN07 3/4" NPT Thread (316L) or threaded flange mount²
- TB07 3/4" BSP Thread (316L)
- TN10 1" NPT Thread (316L)
- TB10 1" BSP Thread (316L)
- TN15 1.5" NPT Thread (316L) or threaded flange mount²
- TB15 1.5" BSP Thread (316L)
- FXXX¹ Pre-Welded Flange (replace XXX with 3 character Welded Flange Code)

Process O-ring seal⁴

- V FKM (Viton) (-20°C to +204°C)
- B NBR (-35°C to +110°C)⁵
- S Silicone (-60°C to +230°C)

Process Temperature

- 1 -40°C to +80°C (-40 to +176°F)
- 2 -40°C to +150°C (-40 to +302°F)

Process Pressure

- 1 5 bar
- 3 20 bar
- 4 40 bar
- 5 100 bar⁶

Approval Standard

- XX Not Required
- 1D IECEx Ex ia/d [ia Ga] IIC T6 Ga/Gb Tamb 60°C
- 2D IECEx Ex ia tb [ia Da] IIIC T85C Da Db Tamb 60°C
- A2 ATEX Grp II Cat 3 GD IP66 Tamb -40°C to 60°C

Probe Length³

Specify in cm to the nearest 10cm

¹See Weld Code selection in Flange Table.

²Order flange as separate line item. See Probe / Mounting combination table matching size and variants options. See Flange Table Accessory Code for ordering.

³See Probe Table for valid Probe, Variant / Materials, Mounting and Length combinations prior to selection.

⁴Select O-Ring based on application requirements.

⁵Not available with Process Temperature option 2

⁶Not available with Mounting Options TN15, TB15

CGR2 H 1 3 B04 S TN07 S 1 1 1D 200

Probe / Mounting Combination Table (subject to change)

Probe Code	Variant / Materials	Mounting	Flange Sizes		Max. Length
			Min. Size	Max size	
A04 / J04	S	TN07, TB07, FXXX	1", DN25, 25mm	1-1/2", DN40, 40mm	1850cm
A06 / J06	S	TN10, TB10	N/A	N/A	1850cm
A08 / J08	S	TN15, TB15, FXXX	2", DN50, 50mm	4", DN100, 100mm	1850cm
B04 / K04	S	TN07, TB07, FXXX	1", DN25, 25mm	1-1/2", DN40, 40mm	400cm
B06 / K06	S	TN10, TB10	N/A	N/A	400cm
B08 / K08	S	TN15, TB15, FXXX	2", DN50, 50mm	4", DN100, 100mm	400cm



Flange Table (subject to change)

Accessory Code	Welded Code	Type (all options Blind Flanges)	Material	Bore Hole (threaded type only)	Matching Mounting Thread (threaded type only)
FLA-1A1-SS-TN07	F1A1	1" ANSI B16.5 150LB	316L	3/4" NPT	TN07
FLA-1A3-SS-TN07	F1A3	1" ANSI B16.5 300LB	316L	3/4" NPT	TN07
FLA-1A6-SS-TN07	F1A6	1" ANSI B16.5 600LB	316L	3/4" NPT	TN07
FLA-1A9-SS-TN07	F1A9	1" ANSI B16.5 900LB	316L	3/4" NPT	TN07
FLA-1AA-SS-TN07	F1AA	1" ANSI B16.5 1500LB	316L	3/4" NPT	TN07
FLA-1AB-SS-TN07	F1AB	1" ANSI B16.5 2500LB	316L	3/4" NPT	TN07
FLA-HA1-SS-TN07	FHA1	1-1/2" ANSI B16.5 300LB	316L	3/4" NPT	TN07
FLA-HA3-SS-TN07	FHA3	1-1/2" ANSI B16.5 600LB	316L	3/4" NPT	TN07
FLA-HA6-SS-TN07	FHA6	1-1/2" ANSI B16.5 900LB	316L	3/4" NPT	TN07
FLA-HA9-SS-TN07	FHA9	1-1/2" ANSI B16.5 900LB	316L	3/4" NPT	TN07
FLA-HAA-SS-TN07	FHAA	1-1/2" ANSI B16.5 1500LB	316L	3/4" NPT	TN07
FLA-HAB-SS-TN07	FHAB	1-1/2" ANSI B16.5 2500LB	316L	3/4" NPT	TN07
FLA-2A1-SS-TN15	F2A1	2" ANSI B16.5 150LB	316L	1.5" NPT	TN15
FLA-2A3-SS-TN15	F2A3	2" ANSI B16.5 300LB	316L	1.5" NPT	TN15
FLA-2A6-SS-TN15	F2A6	2" ANSI B16.5 600LB	316L	1.5" NPT	TN15
FLA-2A9-SS-TN15	F2A9	2" ANSI B16.5 900LB	316L	1.5" NPT	TN15
FLA-2AA-SS-TN15	F2AA	2" ANSI B16.5 1500LB	316L	1.5" NPT	TN15
FLA-2AB-SS-TN15	F2AB	2" ANSI B16.5 2500LB	316L	1.5" NPT	TN15
FLA-3A1-SS-TN15	F3A1	3" ANSI B16.5 150LB	316L	1.5" NPT	TN15
FLA-3A3-SS-TN15	F3A3	3" ANSI B16.5 300LB	316L	1.5" NPT	TN15
FLA-3A6-SS-TN15	F3A6	3" ANSI B16.5 600LB	316L	1.5" NPT	TN15
FLA-3A9-SS-TN15	F3A9	3" ANSI B16.5 900LB	316L	1.5" NPT	TN15
FLA-3AA-SS-TN15	F3AA	3" ANSI B16.5 1500LB	316L	1.5" NPT	TN15
FLA-3AB-SS-TN15	F3AB	3" ANSI B16.5 2500LB	316L	1.5" NPT	TN15
FLA-4A1-SS-TN15	F4A1	4" ANSI B16.5 150LB	316L	1.5" NPT	TN15
FLA-4A3-SS-TN15	F4A3	4" ANSI B16.5 300LB	316L	1.5" NPT	TN15
FLA-4A6-SS-TN15	F4A6	4" ANSI B16.5 600LB	316L	1.5" NPT	TN15
FLA-4A9-SS-TN15	F4A9	4" ANSI B16.5 900LB	316L	1.5" NPT	TN15
FLA-4AA-SS-TN15	F4AA	4" ANSI B16.5 1500LB	316L	1.5" NPT	TN15
FLA-4AB-SS-TN15	F4AB	4" ANSI B16.5 2500LB	316L	1.5" NPT	TN15
FLA-1D1-SS-TN07	F1D1	DN25 DIN2527 PN16	316L	3/4" NPT	TN07
FLA-1D4-SS-TN07	F1D4	DN25 DIN2527 PN40	316L	3/4" NPT	TN07
FLA-HD1-SS-TN07	FHA1	DN40 DIN2527 PN16	316L	3/4" NPT	TN07
FLA-HD4-SS-TN07	FHD4	DN40 DIN2527 PN40	316L	3/4" NPT	TN07
FLA-2D1-SS-TN15	F2D1	DN50 PN16	316L	1.5" NPT	TN15
FLA-2D4-SS-TN15	F2D4	DN50 PN40	316L	1.5" NPT	TN15
FLA-3D1-SS-TN15	F3A1	DN80 PN16	316L	1.5" NPT	TN15
FLA-3D4-SS-TN15	F3D4	DN80 PN40	316L	1.5" NPT	TN15
FLA-4D1-SS-TN15	F4A1	DN100 PN16	316L	1.5" NPT	TN15
FLA-4D4-SS-TN15	F4D4	DN100 PN40	316L	1.5" NPT	TN15
FLA-1J1-SS-TN07	F1J1	JIS 25mm 16k	316L	3/4" NPT	TN07
FLA-1J4-SS-TN07	F1J4	JIS 25mm 40k	316L	3/4" NPT	TN07
FLA-HJ1-SS-TN07	FHJ1	JIS 40mm 16k	316L	3/4" NPT	TN07
FLA-HJ4-SS-TN07	FHJ4	JIS 40mm 40k	316L	3/4" NPT	TN07
FLA-2J1-SS-TN15	F2J1	JIS 50mm 16k	316L	1.5" NPT	TN15
FLA-2J4-SS-TN15	F2J4	JIS 50mm 40k	316L	1.5" NPT	TN15
FLA-3J1-SS-TN15	F3J1	JIS 80mm 16k	316L	1.5" NPT	TN15
FLA-3J4-SS-TN15	F3J4	JIS 80mm 40k	316L	1.5" NPT	TN15
FLA-4J1-SS-TN15	F4J1	JIS 100mm 16k	316L	1.5" NPT	TN15
FLA-4J4-SS-TN15	F4J4	JIS 100mm 40k	316L	1.5" NPT	TN15

Specifications

Centurion Guided Radar



Electronics

Power

- 2 wire loop powered
- 24VDC (14 to 28VDC)

Power Consumption

- <500mW @ 24VDC

Analog Output

- 14V @ 0 Ohm
- 19V @ 250 Ohms
- 24V @ 500 Ohms
- Current park at 4mA, 8mA, 12mA

Communications

- HART (Revision 7)
- GoshawkII via HART. Full parameter list

Maximum Range

- Flexible cable probe: 18.5m (60ft 8in)
- Rigid probe: 4m (13ft 1in)

Minimum Range (Blanking)

- 150mm

Dielectric Range

- ≥ 1.5

Frequency

- 2.2 GHz

Resolution

- Analog: 1uA
- Display: 1.0mm

Accuracy¹

- +/- 3mm

Measurements per second

- 3

Response Time

- <1 second (application dependant)

Sum of non linearity, non repeatability, hysteresis

- Analog +/- 0.02%

Repeatability

- +/- 3mm

Memory

- Non-Volatile (No backup battery required)
>10 years data retention

Operating Temperature (Electronics)

- -40°C to +80°C (-40 to +176°F)

Display

- 4 line graphic display (128 x 64 pixels)

Language

- English

Configuration

- 4 button (up down, Cal, Run), GoshawkII via HART

Approvals*

- | | |
|--|--|
| • IECEx Zone 0/1, Zone 1
IECEx TSA 14.0037X
Ex ia/d [ia Ga] IIC T6 Ga/Gb
Tamb = -40°C to +60°C
IP 66, NEMA 4X
(T6 ... T1) | • IECEx Zone 20/21
IECEx TSA 14.0037X
Ex ia tb [ia Da] IIIC T85°C Da Db
Tamb = -40°C to +60°C
IP 66, NEMA 4X |
|--|--|
- ATEX Grp II Cat 3 GD IP66 Tamb -40°C to 60°C

Electromagnetic Compatibility



CAN ICES-3(A)/NMB-3(A)

This device complies with Part 15, Subpart B Class A of the FCC Rules. Operation is subject to the following two conditions: (1) This device may not cause harmful interference, and (2) this device must accept any interference received, including interference that may cause undesired operation.

Note: This equipment has been tested and found to comply with the limits for a Class A digital device, pursuant to part 15 of the FCC rules. These limits are designed to provide reasonable protection against harmful interference when the equipment is operated in a commercial environment. This equipment generates, uses and can radiate radio frequency energy and, if not installed and used in accordance with the instruction manual, may cause harmful interference to radio communications. Operation of this equipment in a residential area is likely to cause harmful interference in which case the user will be required to correct the interference at his own expense.

*Specifications model dependent. Consult part number listing.

¹Accuracy dielectric & material dependent

Specifications

Centurion Guided Radar



Enclosure

Type

- Dual Compartment with Glass window

Material

- Die-cast Copper-Free Aluminium, Epoxy Painted
- 316L Stainless

Cable Entries

- 1/2" NPT
- 3/4" NPT
- M20 x 1.5
- M25 x 1.5

IP Rating

- NEMA 4X
- IP66

Probe

Probe Size / Wetted Materials

- 4mm SS316L rod
- 4mm DIN3055 (7x7 strand) SS316L flexible cable
- 6mm SS316L rod
- 6mm DIN3055 (7x7 strand) SS316L flexible cable
- 8mm SS316L rod
- 8mm DIN3055 (7x7 strand) SS316L flexible cable

Probe Entry Wetted Materials²

- TN07 / TB07 / TN10 / TB10 / Welded Flange¹ SS316L, PEEK
- TN15 / TB15 / Welded Flange¹ - SS 316L, PTFE, GF25

¹ See Probe / Mounting Combination Table for flange types

Probe O-Ring Seals³

- Silicone / VMQ (-60°C to +230°C)
- Nitrile / NBR (-35°C to +110°C)
- Viton (-20°C to +204°C)

Process Connections

- 3/4" NPT or BSP
- 3/4" NPT with Flange
- 1" NPT or BSP
- 1.5" NPT or BSP
- 1.5" NPT with Flange
- Welded Flange

Process Pressure*

- -1 to 100 BAR

Process Temperature³

- -40°C to +80°C (-40 to +176°F)
- -40°C to +150°C (-40 to +302°F)

Tensile Load (flexible cable probes)

- Probe Type: A04 / J04 0.5 ton
- Probe Type: A06 / J06 1.0 ton
- Probe Type: A08 / J08 4.0 ton

Lateral Load (rigid probes)

- Probe Type: B04 / K04 1 Nm
- Probe Type: B06 / K06 3 Nm
- Probe Type: B08 / K08 8 Nm

Maximum Probe Length

- Probe Type: A04 / J04 1850cm
- Probe Type: A06 / J06 1850cm
- Probe Type: A08 / J08 1850cm
- Probe Type: B04 / K04 400cm
- Probe Type: B06 / K06 400cm
- Probe Type: B08 / K08 400cm

Minimum Probe Length

- Probe Type: A04 / J04 100cm
- Probe Type: A06 / J06 100cm
- Probe Type: A08 / J08 100cm
- Probe Type: B04 / K04 20cm
- Probe Type: B06 / K06 20cm
- Probe Type: B08 / K08 20cm

*Specifications model dependent. Consult part number listing.

³ Observe min / max temperatures for O-ring seal.

² Probe Entry

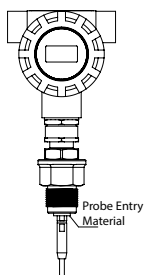

Ordering & Contact Information

Centurion Guided Radar



Ordering Instructions

Threaded unit type

Assemble part number taking note of the valid combinations and exclusions for the full system. The unit is ordered as a single line item. For example:

CGR2H13B08STB15B11XX200

Flanged type - Threaded flange

Assemble part number taking note of the valid combinations and exclusions for the full system (noting smaller flanges require TN07 threaded unit and larger flanges require TN15 threaded unit). The unit and the threaded flange are ordered as separate line items. For example:

CGR2H13B08S**TN15**B11XX200

FLA-FA4-SS-**TN15**

or

CGR2H13B08S**TN07**B11XX200

FLA-FA1-SS-**TN07**

Flanged type - Welded flange

Assemble part number taking note of the valid combinations and exclusions for the full system. In the Mounting part code enter 4 character Welded flange code from the table. All Welded flanges have F as the first character. For example.

CGR2H13B08S**F4A1**B11XX200

Hawk Measurement Systems (Head Office)

15 - 17 Maurice Court
Nunawading VIC 3131, AUSTRALIA

Phone: +61 3 9873 4750

Fax: +61 3 9873 4538

info@hawk.com.au

For more information and global representatives: www.hawkmeasure.com

Technical data subject to change without notice.

Hawk Measurement

96 Glenn Street

Lawrence, MA 01843, USA

Phone: +1 888 HAWKLEVEL (1-888-429-5538)

Phone: +1 978 304 3000

Fax: +1 978 304 1462

info@hawkmeasure.com

Represented by:

