

Trimod[®] Besta

Table of contents

Worldwide in use	Trimod Besta Level Switches	4
Worldwide approved	Approvals	5
Quality for your safety	Certificates and test reports	6
Modular flexibility	Switch-, flange- and float modules	7
Mounting combinations	Numerous examples	8
Various Trimod Besta applications	Application examples	9
Typical switch combinations to handle most applications	Standard Range electric	10
	Standard Range pneumatic	14
	Industrial Range	17
	Plastic Range	19
Specifying your own particular Trimod Besta level switch ...	Switch modules electric	21
	Switch modules explosion-proof	24
	Switch modules pneumatic	26
	Flange modules standard	27
	Flange modules industrial	28
	Flange modules plastic	31
	Float modules	32
	Rod extensions	36
	... or how we can do it for you	Specification sheet
Accessories which save time, labour and expense	Counterflanges	38
	Test actuators	39
	Float chambers	40
Trimod Besta in hazardous areas	Explosion-proof level switches	43
Electrical data to assist type selection	Micro- and proximity switches	44

Trimod Besta Level Switches are used worldwide in many industries



Oil & Gas

Bachofen Ltd. has extensive experience in the Offshore Industry. Some important features of the Trimod Besta product range for oil- & gas applications include stainless steel explosion-proof housings, custom-made float chamber design and NACE compliance.



Shipbuilding

Trimod Besta level switches are specified by the worlds major ship-yards and owners. Much of Bachofen's product development and design has evolved from experience within the Marine Industry such as fully submersible housings and captive terminal components. Trimod Besta level switches are registered worldwide and include LRS, DNV GL, ABS, BV, RINA and RMRS shipping approvals.



Power Generation

Extreme reliability is vital in some of the applications in Power Plants. Shock and vibration resistant Trimod Besta level switches are used for critical turbine trip duties on HP/LP Heater Plants. The Quality Management System ISO 9001 and production on CNC machines assure the highest product standard.



Chemical- & Petrochemical Industry

In the Chemical- and Petrochemical Industry Trimod Besta's modular design can solve many special application problems which may require high pressure, high temperature and corrosion resistant components. For measurement and control of highly aggressive or high purity media we offer a complete program of plastic switches.

Worldwide approved

Trimod Besta level switches have been examined and approved by the most important and internationally recognized organisations. Numerous approvals together with periodic audits warrant continuous quality control throughout the production process. The list of approvals for Trimod Besta level switches and accessories is growing continuously. Contact us for up to date information.



American Bureau of Shipping	ABS
Bureau Veritas, Hamburg	BV
Det Norske Veritas, Oslo Germanischer Lloyd, Hamburg	DNV-GL
Lloyds Register of Shipping	LRS
Registro Italiano Navale, Roma	R.I.N.A
Russian Maritime Register of Shipping	RMRS
exida Certification S.A. Safety Integrity Level	SIL IEC 61508/615

* For current certificates see www.trimodbesta.com



Bureau Veritas, Germany (BV CPS)	EPS 12 ATEX 1430 X	Ex ed IIC T5...T6 Ga/Gb (Z...8) Ex ia IIC T6 Ga/Gb (B...8) Ex ia IIC T6...T2 Ga/Gb (I...8)
	EPS 09 ATEX 1238 X	Ex de IIC T6 Ga/Gb (XA...8) Ex ia d IIC T6...T2 Ga/Gb (XI...8) Ex ia d IIC T6 Ga/Gb (XB...8)
International Electrotechnical Commission (IECEX)	IECEX EPS 15.0038 X	Ex ed IIC T5...T6 Ga/Gb (Z...5) Ex ia IIC T6 Ga/Gb (B...5) Ex ia IIC T6...T2 Ga/Gb (I...5)
	IECEX EPS 15.0037 X	Ex de IIC T6 Ga/Gb (XA...5) Ex ia d IIC T6...T2 Ga/Gb (XI...5) Ex ia d IIC T6 Ga/Gb (XB...5)
EAC Ex (formaly Gost R Ex)	TC RU C-CH.ГБ05.B.00783	Ga/Gb Ex ed IIC T6...T5 X (Z...1) Ga/Gb Ex de IIC T6 X (XA...1) Ga/Gb Ex ia d IIC T6...T2 X (XI...1) Ga/Gb Ex ia d IIC T6 X (XB...1)
Gost R	POCC CH.AB51.H04576	
Swiss TS Technical Services AG	PED-Z-COS.EP.5515489	Cat. IV acc. to PED

Quality for your safety

Quality control is a cornerstone of our management philosophy and therefore, we have integrated the quality system according to ISO 9001 certified by Swiss TS. Thus, quality control to us is not only a strong sales argument, but also an obligation.



Werkzeugnis Test Report Relève de contrôle			EN 10204-2.2	T-100
Unsere Auftragsnummer Our order number Notre no. de commande	x	Ihre Bestellnummer Your order number Votre no. de commande	x	
Kunde Customer Client	x			
Wir bestätigen, dass die unten aufgeführten Teile aus folgenden Materialien hergestellt wurden: We confirm that the following parts are manufactured of materials as follows: Nous confirmons, que les pièces suivantes sont fabriquées soit:				
Bezeichnung Description Désignation	zu Schaltertyp for switch type pour type de contrôleur	Material Material Matériau		
Rückverfolgbarkeit Traceability				
Bei Rückfragen ist die Angabe unserer Auftragsnummer zwingend. With queries, the indication of our order number is mandatory. Ci-joint vous trouvez les Certificats de réception selon EN 10204-3.1 pour les modules de boîtes des Contrôleurs de niveau Trimod Besta.				
Ort, Datum Place, date Lieu, date	Uster,	Unterschrift Signature Signature		
Bachofen AG, Ackerstrasse 42, CH-8610 Uster, Switzerland Phone +41 44 944 11 11, Fax +41 44 944 12 33 info@trimod.ch, www.trimod.ch				

Bescheinigung über Materialprüfungen Certificate of Material Tests Certificat d'essai des matières			T-101
nach/acc. to/ selon EN 10204-3.1			
Unsere Auftragsnummer Our order number Notre no. de commande	x	Ihre Bestellnummer Your order number Votre no. de commande	x
Rückverfolgbarkeit Traceability		Bei Rückfragen ist die Angabe unserer Auftragsnummer zwingend. With queries, the indication of our order number is mandatory.	
Kunde Customer Client	x		
In der Beilage finden Sie die Abnahmeprüfzeugnisse nach EN 10204-3.1 für die Flanschmodule der Trimod Besta Füllstandsicherer. Please find attached the Inspection Certificates according to EN 10204-3.1 for the Flange modules of the Trimod Besta Level Switches. Ci-joint vous trouvez les Certificats de réception selon EN 10204-3.1 pour les modules de boîtes des Contrôleurs de niveau Trimod Besta.			
Ort, Datum Place, date Lieu, date	Uster,	Unterschrift Signature Signature	
Beilagen Annexe x Zeichnung / Drawing			
Bachofen AG, Ackerstrasse 42, CH-8610 Uster, Switzerland Phone +41 44 944 11 11, Fax +41 44 944 12 33 info@trimod.ch, www.trimod.ch			

Trimod'Besta										Prüfprotokoll Test Certificate Certificat d'essai		T-110
Unsere Auftragsnummer Our order number Notre no. de commande	x	Ihre Bestellnummer Your order number Votre no. de commande	x	Kunde Customer Client	x							
Schaltertyp Switch type Type de contrôleur	PN / Class PN / Classe	Prüfdruck kalt / Prüfdruck Test press cold / Test press Press. d'essai froide / Press. d'essai	hydr. / bar bar	Funktionaltest elektr. Schalter Functional test electrical switch Test de fonct. du contrôl. électr.	Isol. / Test Heat. test Test de fonct. du contrôl. pneumatique							
Dichtbarkeit Sealing unit Étanchéité	Schwellenwert Float Unités	Einfachschalter Single switch Contr. simple	Dualschalter Dual switch Contr. double	2 / V	3-Weg-Funktion 3-way function Fonction 3 voies	Q max 1.6 m³/h	Leck max. Fuite max. 100%/min (Class)	Bereich Range Gamma	0,2-1,0 bar			
Ausgenommen Trimod Besta Standardschalter * Trimod Besta standard switches exempt Rückverfolgbarkeit: Bei Rückfragen ist die Angabe unserer Auftragsnummer zwingend. Traceability: With queries, the indication of our order number is mandatory.										Ort, Datum Place, date Lieu, date	Uster,	Unterschrift Signature Signature
Bachofen AG, Ackerstrasse 42, CH-8610 Uster, Switzerland Phone +41 44 944 11 11, Fax +41 44 944 12 33 info@trimod.ch, www.trimod.ch												

The following official Bachofen certificates and test reports are available on request:

T-100 Test report, acc. to EN 10204-2.2

For flange and float materials of the level switches, counterflanges and test actuators.

T-110 Test certificate

For Trimod Besta level switches (electr. function test, pneumatic function test etc.)

T-101 Inspection certificate, acc. to EN 10204-3.1

For flange materials of the level switches, counterflanges and the intermediate part of the test actuators.

The unique modular level switch system



What you need ...

Trimod Besta's modular design is a unique deviation from conventional level switch construction. This modular system allows individual and numerous combinations of float, flange and switch modules to suit your specific requirements. Switch modules are available with electric, electronic or pneumatic output signals. Switch housings are standard to IP65 enclosure, but depending on environmental conditions IP66, IP67 or IP68 must be chosen. For hazardous areas, hermetically sealed microswitches, flameproof housings or pneumatic switch modules can be used.



... is quickly installed ...

Trimod Besta flange modules are available in various standards. The Industrial and Plastic Flange ranges are manufactured according to international standards such as EN/DIN, ANSI, BS or JIS. The benefit of the hinged cover, the captive screws and the selflifting terminal clamps is an easy installation. For convenience of wiring, the connection diagram is shown on the inside of the hinged lid. The interchangeability of the single modules allows high flexibility regarding maintenance or changing application requirements.



... and lasts forever.

So far, hundreds of thousands of Trimod Besta level switches are on duty world-wide. The float movement caused by the rise and fall of the liquid level is transmitted by two repelling, permanent AlNiCo magnets. The sturdy design and the double snap effect as a result of the magnetic repulsion and the snap action of the microswitch guarantee a virtually unlimited lifetime. The float modules, like all wetted parts, are made of stainless steel, Hastelloy C or high quality plastics. A wide range of floats is available to suit various viscosity-, temperature- and pressure ranges for almost any process condition.



With modular compatibility all options are open

Side mount combinations

- 01 with microswitch or proximity switch, also available in explosion proof version
- 02 pneumatic switch module with ON/OFF or proportional output
- 03 with enclosure IP68 for underwater installation
- 04 for explosion proof applications in a pressure-capsulated housing with microswitch or proximity switch
- 05 with heat exchanger for very high or very low operating temperatures
- 06 square standard flanges made of CrNiMo, 92 mm pitch circle diameter
- 07 industrial flange acc. to EN/DIN, ANSI, BS and JIS made of PP and PTFE
- 08 industrial flange acc. to EN/DIN, ANSI, BS and JIS made of CrNiMo and Hastelloy
- 09 with fixed operating differential
- 10 with rod extension for longer operating differentials
- 11 rod extension for switch point correction
- 12 with protective bellows for media with solids content
- 13 with adjustable operating differential for pump control
- 14 plastic versions for aggressive media
- 15 for separation layer monitoring of two media with different densities
- 16 for vertical mounting
- 17 for vertical mounting in plastics
- 18 for vertical mounting with rod extension

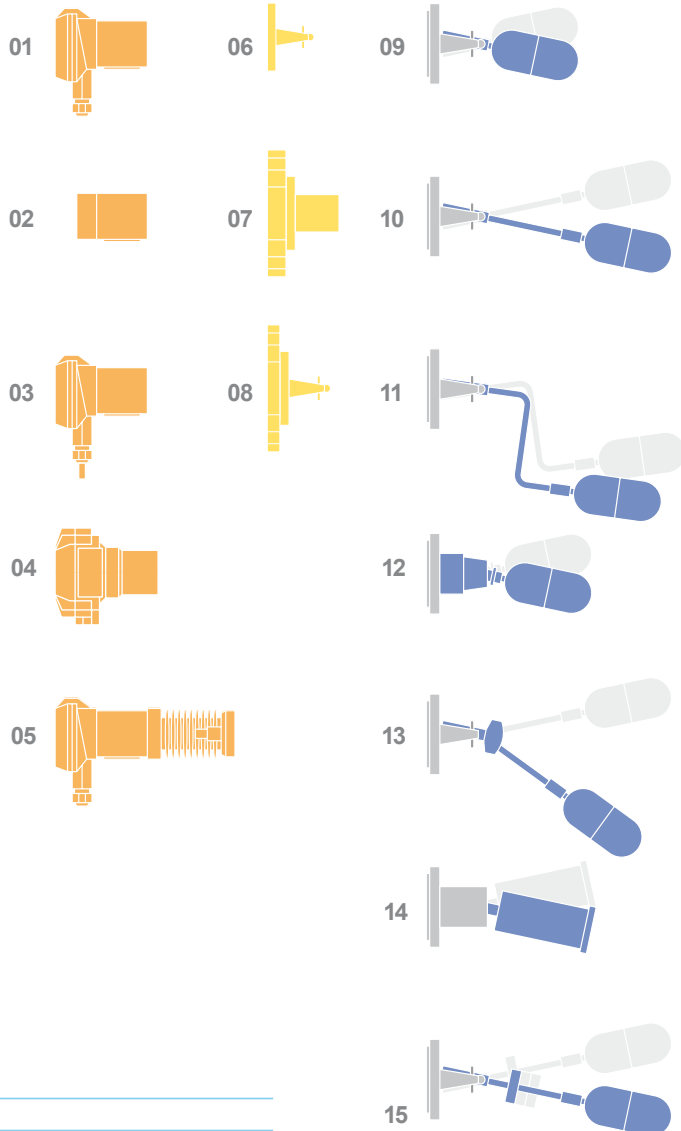

Top mount combinations

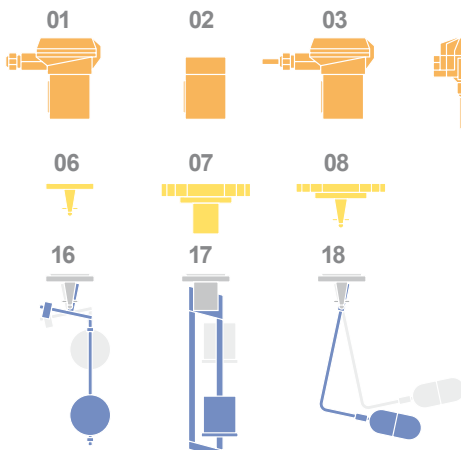

Application examples

Alarm, limit and control functions with Trimod Besta

max/min limits

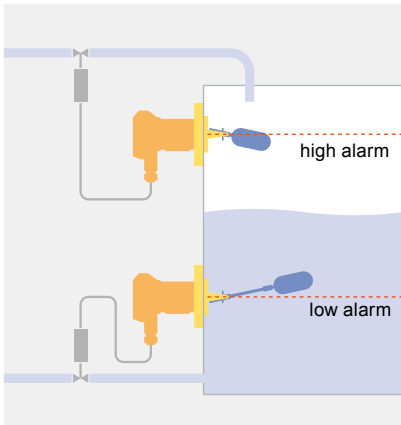

pneumatic control

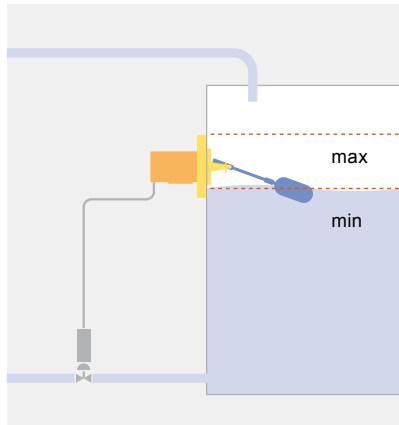

pump and valve control

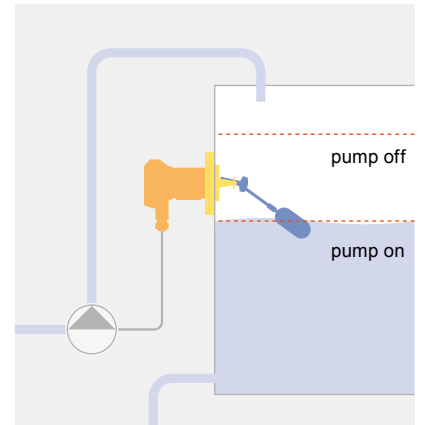

pump and valve control

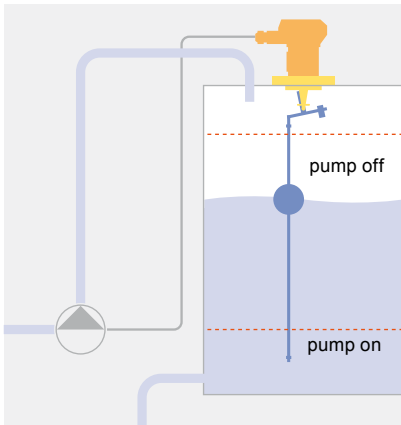

separation layer control

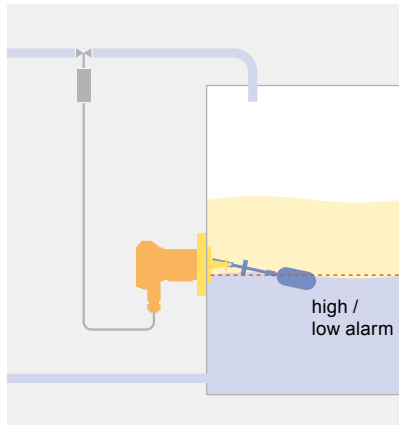

external level control

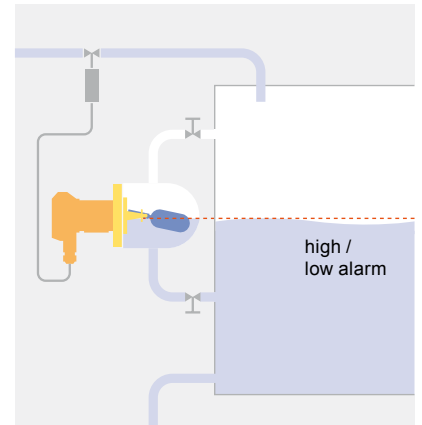

Typical Standard Range switches to handle the majority of applications

The characteristic of a Trimod Besta level switch of the Standard Range is the square flange in stainless steel with bolt holes on a 92 mm PCD and a nominal pressure rating of PN 25.

The following pages show the level switches which are most commonly used. However, countless more combinations of types are possible. Detailed information can be found on all the modules available with the possible combinations on pages 21 to 36. For accessories, such as test actuators, counterflanges and float chambers see pages 38 to 42.

Type A 01 04 - For general purpose

Nominal pressure	PN 25 max. 25 bar up to 300°C
Operating temperature	0 to 300°C
Ambient temperature	0 to 70°C
Density of liquid	min. 0.7 kg/dm ³
Operating differential	fixed 12 mm
Rod extensions	see page 36
Wetside material	Stainless steel (CrNiMo)
Flange material	Stainless steel (CrNiMo)
Housing material	Sea water resistant die cast aluminium
Flange dimensions	square 92 x 92 mm, PCD 92 mm
Counterflange	see page 38
Switch element	Microswitch SPDT with silver contacts
Switch rating	250 VAC, 5 A 30 VDC, 5 A
Enclosure	IP65
Weight	approx. 1.8 kg
Safety Integrity Level (SIL)	SIL 1 (Type AA 01 04: SIL 2)

Type A 01 041 - Low cost solution

This type is the same as the A 01 04 but there is no possibility for mounting a rod extension.

Type A 01 01 - For installation in limited space

The overall length of this type is 194 instead of 225 mm. Minimum liquid density: 0.8 kg/dm³. All other data as type A 01 04.

Type 5A 01 04 - For corrosive environments

As type A 01 04 except that the complete switch housing (excluding the cable gland), is manufactured in stainless steel (CrNiMo) and is therefore highly corrosion resistant.

Weight approx. 2.7 kg.

Type A 01 07 - For low density fluids

This level switch can be used for liquids with densities as low as 0.5 kg/dm³. All other technical data as type A 01 04. Weight approx. 2 kg.

Typical applications: ship-building, refrigeration, chemical engineering, food industry, pulp and paper, drinking water supply, sewage treatment etc.

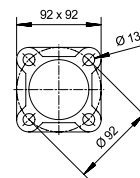
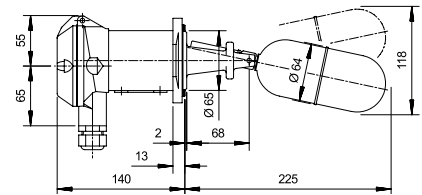

Type A 01 051 to A 01 054 - For contaminated or crystallizing media.

Bellows to prevent jamming of the float mechanism.

Bellow materials	A 01 051	Perbunan/Buna
	A 01 052	Silicon
	A 01 053	FPM
	A 01 054	PTFE
Operating temperatures	A 01 051	0 to 120°C
	A 01 052	0 to 200°C
	A 01 053	10 to 200°C
	A 01 054	0 to 250°C
Mounting length	253 mm	
Weight	approx. 2 kg	
Density of liquid	min. 0.75 kg/dm ³	
Safety Integrity Level (SIL)	SIL 1 (Types AA 01 051 to AA 01 054: SIL 2) All other technical data as type A 01 04	

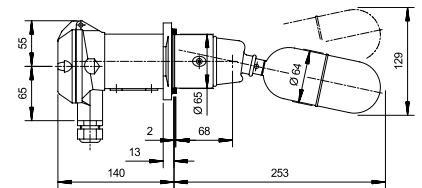
**Type U3A 01 04 to U11A 01 04 - For submersible applications**

	-30 to 80°C	
Operating temperature	-30 to 80°C	
Ambient temperature	Sea water resistant die cast aluminium	
Housing material	IP68	
Enclosure	switch housing is pressure tight up to 100 meters WC (Water column)	
Length of encapsulated cable	U3A 01 04	3 m
	U5A 01 04	5 m
	U11A 01 04	11 m
Weight	U3A 01 04	approx. 2.5 kg
	U5A 01 04	approx. 2.8 kg
	U11A 01 04	approx. 4 kg
Safety Integrity Level (SIL)	SIL 1 (Types U3AA 01 04 to U11AA 01 04: SIL 2) All other technical data as type A 01 04	

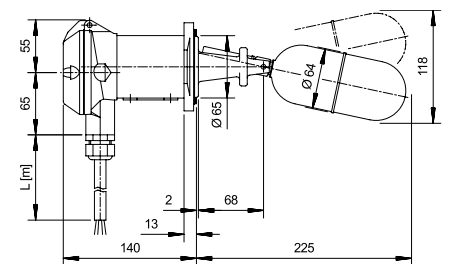
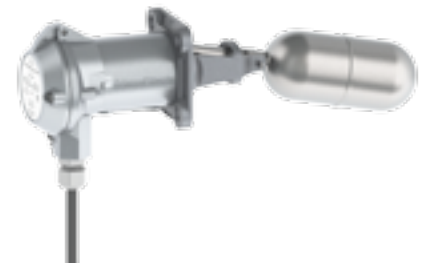
**Type A 01 08T1 - For interface application**

Density of heavier liquids	min. 0.8 kg/dm ³	
Difference in density	min. 0.22 kg/dm ³	
Operating differential	approx. 20 mm	
Rod length	100 mm	
Weight	approx. 2.4 kg	
Safety Integrity Level (SIL)	SIL 1 (Type AA 01 08T1: SIL 2) All other technical data as type A 01 04	

The position of the weight on the rod extension is calculated in reference to the densities of the media and is factory preset.

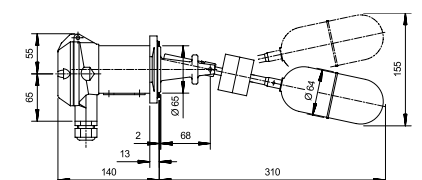

Type A 01 140 to A 01 141 - For vertical mounting

Nominal pressure	PN 16, max. 16 bar up to 300°C
Operating temperature	0 to 300°C
Ambient temperature	0 to 70°C
Density of liquid	
pump control	0.45 kg/dm ³
alarm	0.30 kg/dm ³
Operating differential S	A 01 140: 12 to 1340 mm A 01 141: 12 to 2840 mm
Wetside material	Stainless steel (CrNiMo)
Flange material	Stainless steel (CrNiMo)
Housing material	Sea water resistant die cast aluminium
Flange dimensions	square 92 x 92 mm, PCD 92 mm
Counterflange	see page 38
Switch element	Microswitch SPDT with silver contacts
Switch rating	250 VAC, 5A 30 VDC, 5A
Enclosure	IP65
Weight	A 01 140: 2.5 kg, A 01 141: 2.7 kg
Safety Integrity Level (SIL)	SIL 1 (Types AA 01 140 to AA 01 141: SIL 2)

Setting the switching differential**1. For pump control (two switch points):**

The required differential is set by fixing the two stop collars in the appropriate positions on the rod. The counterweight is adjusted to compensate for the rod weight (without float), until the cross arm is balanced. The float slides up and down the rod with the liquid level and actuates the switch at the set position of the stop collars.

The switch remains latched between the two positions, which are for applications such as pump control where the contactor coil would need to remain energised throughout the pumping cycle.

2. For alarm duty (one switch point):

Only the lower collar is fixed on the rod (below the float). Within the limit of the rod length, the height of the alarm point can be chosen as required. The counterweight has to be set to outweigh the rod (without float). The alarm switching differential is 12 mm, fixed.

Installation

Over open tanks or sumps on a bracket. On closed tanks on the manhole cover with float mounted from the inside. In the absence of a manhole, i.e. the float cannot be mounted from the inside, an intermediate flange of at least DN 125/5" should be used. If turbulence occurs, the rod should be guided loosely at the lower end. For counterweight setting, refer to data sheet LTDS02EN.

Type U3A 01 140 to 141 - For vertical submersible mounting

Operating temperature	-30 to 80°C
Ambient temperature	-30 to 80°C
Enclosure	IP68 switch housing is pressure proof up to 100 meters WC (Water column)
Length of cast-in cable	3 m
Weight	U3A 01 140: 3.2 kg, U3A 01 141: 3.4 kg
Safety Integrity Level (SIL)	SIL 1 (Types U3AA 01 140 to U3AA 01 141: SIL 2)
	All other technical data as described above

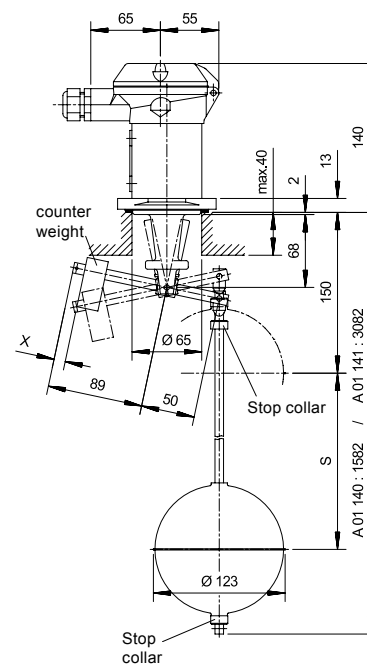

Type P 01 04 - For pneumatic control applications

Equipped with a directly controlled 3/2 way valve (ON/OFF) for control air of 0 to 10 bar. Operation with other non-corrosive gases or fluids is possible.

Nominal pressure	PN 25, max. 25 bar up to 250°C
Operating temperature	1 to 250°C
Ambient temperature	1 to 80°C
Density of liquid	min. 0.7 kg/dm ³
Operating differential	fixed 12 mm
Rod extension	see page 36
Control connections	G 1/8" (BSPP) inside thread
Max. control pressure	10 bar
Internal orifice	1.5 mm
Kv Factor	1
Internal leakage rate at 10 bar	max. 1 cm ³ /min
Air flow	90 NI/min at 6 bar
Pressure drop	1 bar
Wetside material	Stainless steel (CrNiMo)
Flange material	Stainless steel (CrNiMo)
Housing material	Sea water resistant die cast aluminium
Counterflange	see page 38
Flange dimensions	square 92 x 92 mm, PCD 92 mm
Weight	approx. 1.7 kg class 4, ISO 8571
Air quality	(max. particle size 15 µm, max. particle density 8 mg/m ³)

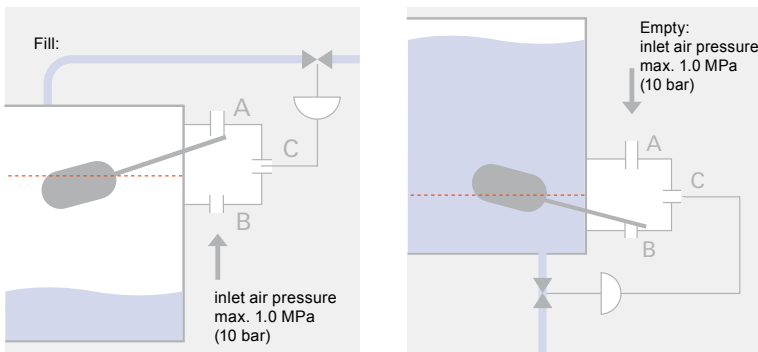
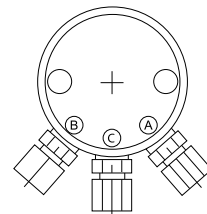
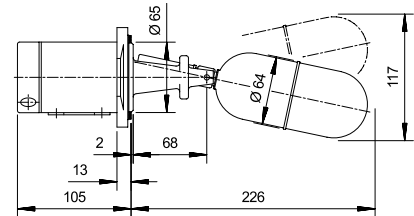

The air supply to the 3/2 way valve may be connected to either A or B, according to whether filling or emptying operation is desired or whether the actuator is normally closed or open when pressurized. E.g. pressure can be applied through A to C and exhausted from C through B, alternatively pressure can be applied through B to C and exhausted from C through A.

Type 5P 01 04 - For critical environments or high temperatures. All parts stainless steel. As P 01 04, but switch housing also in stainless steel (CrNiMo) and therefore, highly corrosion resistant and suitable for temperatures up to 300°C. Weight approximately 2.2 kg.

Type PV 01 04 - For moist control air. As P 01 04, but with drain valve for condensate removal.

Type FP 01 04 - For hazardous applications. As P 01 04, but functionally tested. With declaration of conformity for use in explosion proof areas.

Type FPV 01 04 - For moist control air in hazardous applications. As FP 01 04, but with drain valve for condensate removal. With declaration of conformity for use in explosion proof areas.



Type M 01 04 - For pneumatic proportional control applications

Equipped with a pneumatic control valve which converts the supply pressure of 1.4 bar to an output signal of 0.2 to 1 bar (Option: 7 to 15 psi), proportional to changes in the liquid level.

Nominal pressure	PN 25, max. 25 bar up to 250°C
Operating temperature	1 to 250°C
Ambient temperature	1 to 80°C
Density of liquid	min. 0.7 kg/dm ³
Control range	see table below
Control connections	G 1/8" (BSPP) inside thread
Control pressure	1.4 bar
Output signal	0.2 to 1 bar
Linearity	±5% (of full scale output)
Air flow	3.5 to 6.0 NI/min. (can be increased by using external booster valve)
Air consumption	max. 0.4 Nm ³ /h
Wetside material	Stainless steel (CrNiMo)
Flange material	Stainless steel (CrNiMo)
Housing material	Sea water resistant die cast aluminium
Flange dimensions	square 92 x 92 mm, PCD 92 mm
Counterflange	see page 38
Weight	approx. 1.7 kg
Air quality	class 3, ISO 8571 (max. particle size 5 µm, max. particle density 5 mg/m ³)

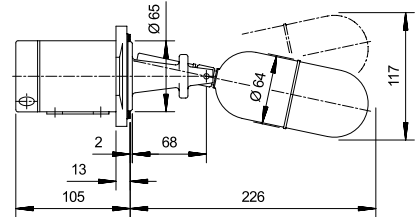

For operation at higher control pressure up to max. 10 bar

Control pressure in bar	Output signal in bar		Control range P max / P min
	min.	max.	
2	0.25	1.5	6
4	0.6	3.1	5.17
6	1.1	4.8	4.36
8	1.8	6.5	3.61
10	2.5	8.3	3.32

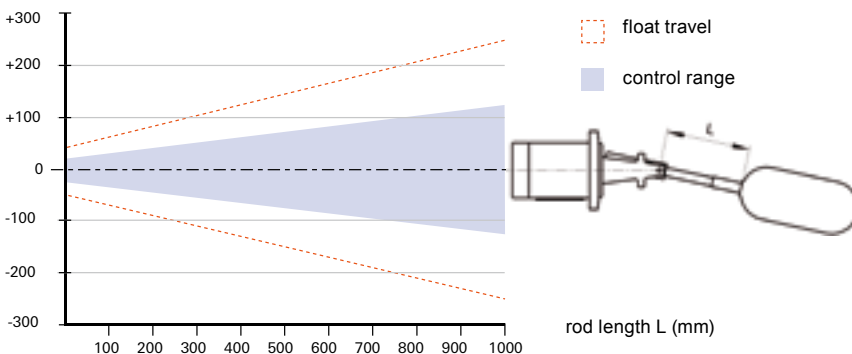

Control range

The normal control range is 30 mm, i.e. +15 mm/-15 mm from the centre line, measured in water at 20°C. With the float in the central position, the output is 0.6 bar. The control range can be increased by lengthening the float arm (see graph left).

Type 5M 01 04 - For critical environments or high temperatures.**All parts stainless steel.**

As M 01 04, but housing also in stainless steel (CrNiMo) and therefore, highly corrosion resistant and suitable for operating temperatures up to 300°C.
Weight approximately 2.2 kg.

Type MV 01 04 - For moist control air

As M 01 04, but with drain valve for condensate removal.

Type FM 01 04 - For hazardous applications

As M 01 04, but functionally tested. With declaration of conformity for use in explosion proof areas.

Type FMV 01 04 - For moist control air in hazardous applications

As FM 01 04, but with drain valve for condensate removal.

With declaration of conformity for use in explosion proof areas.

**Control function**

The standard air connection configuration is shown here (fig. A). When filling, the output signal is decreasing proportionally to the rising level.

The reverse function is obtained by turning the switch housing 180°C

(see fig. B). This can be accomplished without interrupting the process.

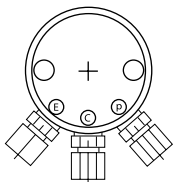

figure A

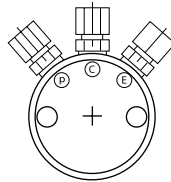
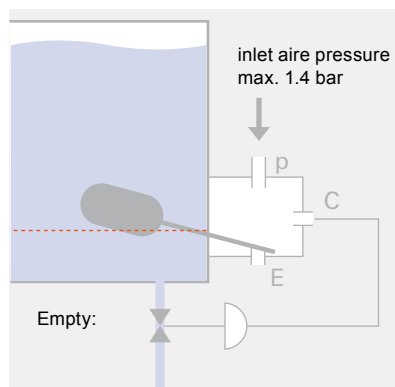
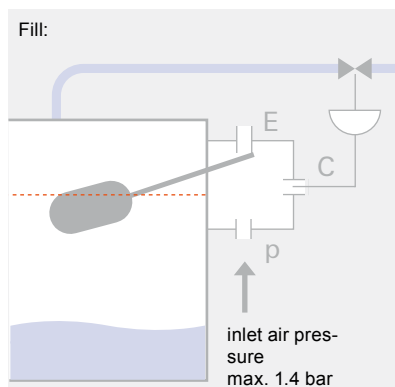

figure B



The Industrial Range offers numerous flange combinations

The main feature of the Industrial Range is the wide choice of flange modules, manufactured according to international standards such as EN/DIN, ANSI, BS or JIS. Available in various steel qualities, nominal sizes and pressure ratings (e.g. up to PN 320 acc. to EN/DIN or class 2500 acc. to ANSI). Shown here are only a few typical combinations, many more possibilities can be found in the module descriptions. All types in the Standard Range shown on the previous pages can of course also be combined with industrial flanges.

Type A 22C 04 - For general purpose

Nominal pressure	PN 40
Operating temperature	0 to 330°C
Ambient temperature	0 to 70°C
Density of liquid	min. 0.7 kg/dm ³
Operating differential	fixed 12 mm
Rod extension	see page 36
Wetside material	Stainless steel (CrNiMo)
Flange material	
Seal part	Stainless steel (CrNiMo)
Slip-on Flange	Carbon steel P265GH, zinc galvanised and passivated
Housing material	Sea water resistant die cast aluminium
Flange	DN 65, PN 40 acc. to EN 1092-1 (DIN 2501)
Flange facing	Raised face type B1 (type C - DIN 2526)
Switch element	Microswitch SPDT with silver contacts
Switch rating	250 VAC, 5 A 30 VDC, 5 A
Enclosure	IP65
Weight	approx. 5.4 kg
Safety Integrity Level (SIL)	SIL 1 (Type AA 22C 04: SIL 2)

Frequently used on off-shore rigs, in steam boilers and plants, power stations, chemical and petrochemical engineering, heating and refrigeration, i.e. airconditioning technology.

SIL
IEC 61508/1511 **SIL 3 Capable**

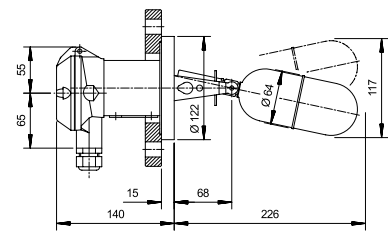
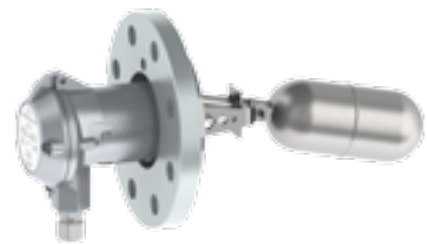

Type B 132R 07 - For low voltage circuits and low density liquids

For use in low-voltage controls or logic circuits. Especially when long down-times or sulfur-containing environments are to be expected. For hazardous area see also Ex-level switches page 43.

Nominal pressure	ANSI cl. 300 lbs
Operating temperature	0 to 330°C
Ambient temperature	0 to 70°C
Density of liquid	min. 0.5 kg/dm ³
Operating differential	fixed 12 mm
Wetside material	Stainless steel (CrNiMo)
Flange material	
Seal part	Stainless steel (CrNiMo)
Slip-on Flange	Carbon steel P265GH, zinc galvanised and passivated
Housing material	Sea water resistant die cast aluminium
Flange	DN 3", PN cl.300 ANSI B16.5
Flange facing	Raised face
Switch element	Microswitch SPDT with gold plated contacts
Enclosure	IP65
Weight	approx. 8.6 kg
Safety Integrity Level (SIL)	SIL 1 (Type BB 132R 07: SIL 2)

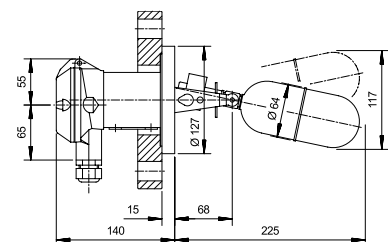
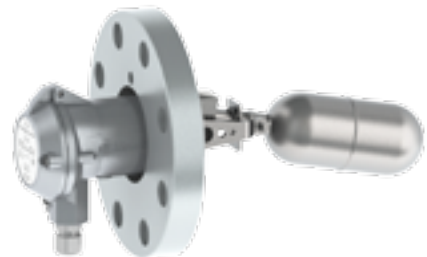

Type HA 24E 02 - For high temperature

Nominal pressure	PN 100
Operating temperature	0 to 400°C
Ambient temperature	0 to 135°C
Density of liquid	min. 0.7 kg/dm ³
Operating differential	fixed 12 mm
Rod extension	see page 36
Wetside material	Stainless steel (CrNiMo)
Flange material	
Seal part	Stainless steel (CrNiMo)
Slip-on Flange	Carbon steel P265GH, zinc galvanised and passivated
Housing material	seawater resistant, die cast aluminium
Flange	DN 65, PN 100 acc. to EN 1092-1 (DIN 2501)
Flange facing	Raised face type B2 (type E - DIN 2526)
Switch element	Microswitch SPDT with silver contacts
Switch rating	250 VAC, 5 A 30 VDC, 5 A
Enclosure	IP65
Weight	approx. 9.6 kg
Safety Integrity Level (SIL)	SIL 1 (Type HAA 24E 02: SIL 2)

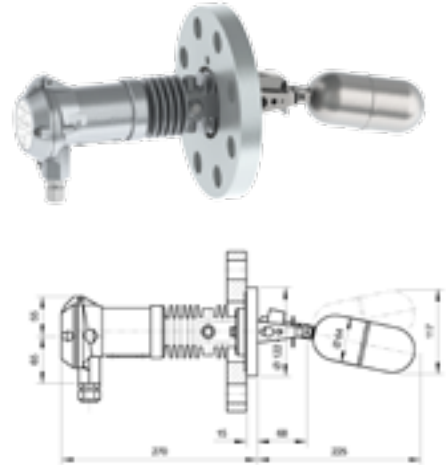
**Type 5TDI 22CF 041 - For low temperature and severe environmental conditions**

Completely in stainless steel with fixed flange. For hazardous area see also Ex-level switches page 43.

Nominal pressure	PN 40
Operating temperature	-196°C to 270°C
Ambient temperature	-10°C to 80°C
Density of liquid	min. 0.7 kg/dm ³
Operating differential	fixed 12 mm
Wetside material	Stainless steel (CrNiMo)
Flange material	Stainless steel (CrNiMo)
Housing material	Stainless steel (CrNiMo)
Flange	DN 65, PN 40 acc. to EN 1092-1 (DIN 2501)
Flange facing	Raised face type B1 (type C - DIN 2526)
Switch element	Inductive proximity switch acc. to NAMUR/EN 60947-5-6
Nominal voltage	8.2 VDC ±5%
Operating voltage	5 to 25 VDC
Current output	Proximity open: ≥2.2 mA float down Proximity closed: ≤1 mA float up
Function	as high alarm: at closed circuit as low alarm: at operating circuit
For inverse function	Type 5TDIN 22CF 041
Enclosure	IP66/IP67
Weight	approx. 7.7 kg
Safety Integrity Level (SIL)	SIL 1

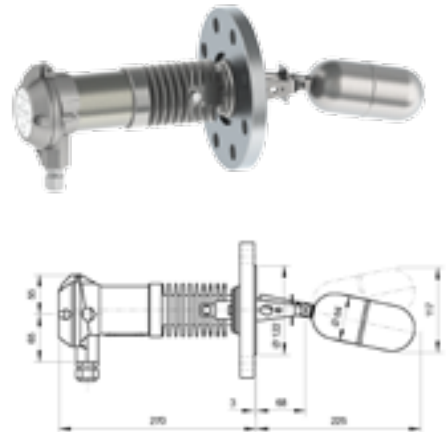

The Plastic Range for corrosive or high purity media

The main feature of the Plastic Range is that all wet-side materials are in corrosion resistant plastics such as PP or PTFE. Following are four typical examples, but these are by no means the limit of possible combinations which can be specified by reference to the module descriptions on pages 21 to 35.

Type A 301 99 - For general use in PP

Nominal pressure	PN 10	max. 10 bar up to 25°C max. 5 bar at 45°C max. 2.5 bar at 60°C
Operating temperature	0 to 60°C	
Ambient temperature	0 to 60°C	
Density of liquid	min. 0.65 kg/dm ³	
Operating differential	fixed 12 mm	
Rod extension	see page 36	
Wet-side material	PP	
Flange material	Seal part: PP Slip-on Flange: PVC	
Housing material	Sea water resistant die cast aluminium	
Flange	DN 80, PN 10 acc. to EN 1092-1 (DIN 2501)	
Flange facing	Raised face type B1 (type C - DIN 2526)	
Switch element	Microswitch SPDT with silver contacts	
Switch rating	250 VAC, 5 A 30 VDC, 5 A	
Enclosure	IP65	
Weight	approx. 1.9 kg	

Type A 304 98 - For high temperature and corrosive applications in PTFE

Nominal pressure	PN 6	max. 6 bar up to 65°C max. 4.5 bar at 100°C max. 3 bar at 200°C
Operating temperature	0 to 200°C	
Ambient temperature	0 to 70°C	
Density of liquid	min. 0.75 kg/dm ³	
Operating differential	fixed 12 mm	
Rod extension	see page 36	
Wet-side material	PTFE	
Flange material	Seal part: PTFE 25% GRP Slip-on Flange: Carbon steel P265GH, zinc galvanised and passivated	
Housing material	Sea water resistant die cast aluminium	
Flange	DN 80, PN 10 acc. to EN 1092-1 (DIN 2501)	
Flange facing	Raised face type B1 (type C - DIN 2526)	
Switch element	Microswitch SPDT with silver contacts	
Switch rating	250 VAC, 5 A 30 VDC, 5 A	
Enclosure	IP65	
Weight	approx. 5 kg	

Vacuum Applications:

For vacuum duty a modified sealing must be used, suffix to flange code is E20, e.g. A 301E20 99. This must be specified in the purchase order. The vacuum sealing unit is capable of operating to 0 bar absolute pressure.
Proven application areas: chemical engineering, electroplating, food industry, etc.

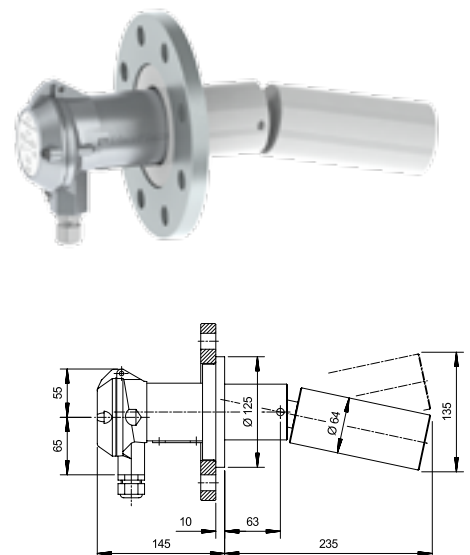
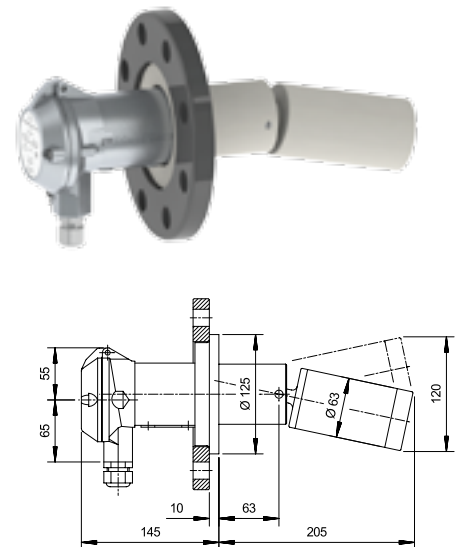

Type A 501 97 - For vertical mounting in PP for alarm or pump control

Nominal pressure	PN 10 max. 10 bar up to 25°C max. 5 bar at 45°C max. 2.5 bar at 60°C
Operating temperature	0 to 60°C
Ambient temperature	0 to 60°C
Density of liquid	min. 0.5 kg/dm ³
Operating differential S	12 to 1730 mm
Wetside material	PP
Flange material	Seal part: PP Slip-on Flange: PVC
Housing material	Sea water resistant die cast aluminium
Flange	DN 125, PN 10 acc. to EN 1092-1 (DIN 2501)
Flange facing	Raised face type B1 (type C - DIN 2526)
Switch element	Microswitch SPDT with silver contacts
Switch rating	250 VAC, 5 A 30 VDC, 5 A
Enclosure	IP65
Weight	approx. 3.1 kg



Switch modules

The switch module is selected according to the type of control required, switching capability, environmental conditions and the working temperature in the vessel. The key on page 22 shows how the designation code is structured. The details of the switch modules are listed in the following tables 1 to 13. In accordance with the relevant EU-directives and where applicable, Trimod Besta level switches are marked **CE**.

Table 1

Electrical/Electronic Basic Modules, IP65

With 1 or 2 switches, galvanically isolated and with earthed encapsulation. Enclosure type IP65. Housing in sea water resistant die cast aluminium, with cable gland M20x1.5.

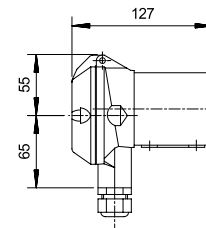

Table 1

Type	Function	SIL	Rating	Temperature in °C Operating	Temperature in °C Ambient	Connection diagram
A	SPDT Microswitch with silver contacts	SIL 1	250 VAC, 5 A 30 VDC, 5 A	0 to +330	0 to +70	
AA	Dual SPDT Microswitches with silver contacts, galvanically isolated	SIL 2	250 VAC, 5 A 30 VDC, 5 A	0 to +330	0 to +70	
B	SPDT Microswitch with gold plated contacts	SIL 1	0.3 A / 30 VDC	0 to +330	0 to +70	
BB	Dual SPDT Microswitches with gold plated contacts, galvanically isolated	SIL 2	0.3 A / 30 VDC	0 to +330	0 to +70	
I	Proximity switches acc. to NAMUR/EN 60947-5-6. As high alarm in the quiescent current mode or as a low alarm in the working current mode. Float up: Proximity switch damped: I ≤ 1 mA Float down: Proximity switch undamped: I ≥ 2.2 mA	SIL 1	$U_N 8.2 \text{ VDC} \pm 5\%$ ($U_B 5$ to 25 VDC)	0 to +150	0 to +70	
IN	Proximity switches acc. to NAMUR/EN 60947-5-6. As low alarm in the quiescent current mode or as a high alarm in the working current mode. Float up: Proximity switch undamped: I ≥ 2.2 mA Float down: Proximity switch damped: I ≤ 1 mA	SIL 1	$U_N 8.2 \text{ VDC} \pm 5\%$ ($U_B 5$ to 25 VDC)	0 to +150	0 to +70	
II	Dual proximity switches acc. to NAMUR/EN 60947-5-6. High/low level, galvanically isolated. Combination of I and IN.	SIL 1	$U_N 8.2 \text{ VDC} \pm 5\%$ ($U_B 5$ to 25 VDC)	0 to +150	0 to +70	
IE9	Self-checking proximity switch acc. to NAMUR/EN 60947-5-6, TÜV approved. As high alarm in the quiescent current mode. Float up: proximity switch damped: I ≤ 1 mA For self-checking operate in quiescent current mode.	SIL 1	$U_N 8.2 \text{ VDC} \pm 5\%$ ($U_B 5$ to 25 VDC)	0 to +150	0 to +70	
INE9	Self-checking proximity switch acc. to NAMUR/EN 60947-5-6, TÜV approved. As low alarm in the quiescent current mode. Float down: proximity switch damped: I ≤ 1 mA For self-checking operate in quiescent current mode	SIL 1	$U_N 8.2 \text{ VDC} \pm 5\%$ ($U_B 5$ to 25 VDC)	0 to +150	0 to +70	
IIE9	Dual self-checking proximity switches acc. to NAMUR/EN 60947-5-6, TÜV approved. High/low level, galvanically isolated. Combination of IE9 and INE9.	SIL 1	$U_N 8.2 \text{ VDC} \pm 5\%$ ($U_B 5$ to 25 VDC)	0 to +150	0 to +70	

Key to type numbers

Switch module

Prefix

Basic
module

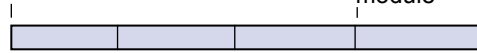

Flange module

Page 27

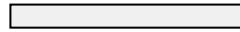

Float module

Page 32

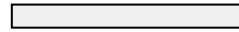

Switch module (electric / electronic / pneumatic)

Increased protection (IP66 / IP67 / IP68)
High or low temperature version

Switch module housing material option (chromated/complete in stainless steel CrNiMo)

Cable gland other than M20x1.5

Thread for cable gland

The types in Tables 1, 2, 4 and 5 are available on request with a cable gland thread other than M20x1.5.

Prefix	Cable gland
10	Marine execution (DIN 89280), Type W
30	Marine execution (DIN 89280), Type Z
40	Internal thread 3/4" NPT (without cable gland)

Housing material coatings for enhanced requirements

Chromated housing (ROHS conform)

The types in Tables 1, 2, 7 and 11 are also available with chromated housing. The designation prefix is 2. The types in Tables 3, 4, 5, 9, and 10 are chromated as standard.

Example: 2DA or X2B8

Stainless steel housing (CrNiMo/316SS)

All switch modules in Tables 1 to 11 are also available in stainless steel. The designation prefix is 5.

Example: 5DA or X5A8

Epoxy coated housing

Most switches are available with Epoxy coating.

Designation suffix: E46 Epoxy coating grey
E146 Epoxy coating white

Example: DAE46

Table 2

Increased protection enclosure IP66/IP67

All basic modules in Table 1 are also available in IP66/IP67. The designation prefix is D. All data in Table 1, except for the temperature rating remain unchanged. For high temperatures (operating -40°C to +200°C, ambient -40°C to +120°C), add E28, e.g. DAE28



Type	Temperature in °C	
	Operating	Ambient
DA / DAA*	-30 to +120	-30 to +120
DB / DBB*	-30 to +120	-30 to +120
DI / DIN / DII	-30 to +120	-20 to +90
DIE9 / DINE9 / DIIIE9	-30 to +120	-30 to +90

Safety Integrity Level (SIL): all types SIL 1
Types DAA / DBB: *SIL 2

Table 3

Submersible version IP68

All basic modules in Table 1 are also available for submerged applications (IP68) to 100 m depth with chromated housing. The designation prefix is U3, U5 or U11. The designation 3, 5 and 11 specifies standard lengths of encapsulated cable in meters (longer cables are available). All data in Table 1, except for temperature rating, remain unchanged. Housing: chromated.



Type	Temperature in °C	
	Operating	Ambient
U3A / U3AA*	-30 to +80	-30 to +80
U3B / U3BB*	-30 to +80	-30 to +80
U3I / U3IN / U3II	-25 to +80	-25 to +80
U3IE9 / U3INE9 / U3IIE9	-30 to +80	-30 to +80

Safety Integrity Level (SIL): all types SIL 1
Types U3AA / U3BB: *SIL 2

Table 4

High operating temperature

All basic modules in Table 1 are also available in a high temperature version with chromated housing IP65. The designation prefix is H. All data in Table 1, except for temperature rating and connection diagram, remain unchanged.



Type	Temperature in °C	
	Operating	Ambient
HA / HAA*	0 to +400	0 to +135
HB / HBB*	0 to +400	0 to +135
HI / HIN / HII	0 to +300	0 to +75
HIE9 / HINE9 / HIIIE9	0 to +300	0 to +75

Safety Integrity Level (SIL): all types SIL 1
Types HAA / HBB: *SIL 2

Table 5

Low operating temperature

All basic modules in Table 1 are also available in a low temperature version with chromated housing IP66/IP67. The designation prefix is TD. All data in Table 1, except for temperature rating and connection diagram, remain unchanged.



Type	Temperature in °C	
	Operating	Ambient
TDA / TDAA*	-196 to +270	-10 to +80
TDB / TDBB*	-196 to +270	-10 to +80
TDI / TDIN / TDII	-196 to +270	-10 to +80
TDIE9 / TDINE9 / TDIIIE9	-196 to +270	-10 to +80

Safety Integrity Level (SIL): all types SIL 1
Types TDAA / TDBB: *SIL 2

Table 6

Ex-Switches for intrinsically safe circuits (Ex-i)

The level switches with switch modules of types I, IE9 and B are designed also for use in hazardous areas. Technical details, see page 43.

Example: IE98

Approved types	Designation	Type acc. to	Approval authority	Classification	Certificate
I... / IE9...	8	2014/34/EU	BV CPS	Ex ia IIC T6...T2 Ga/Gb	EPS 12 ATEX 1430 X
I... / IE9...	5	IECEX scheme	BV CPS	Ex ia IIC T6...T2 Ga/Gb	IECEX EPS 15.0038 X
B...	8	2014/34/EU	BV CPS	Ex ia IIC T6 Ga/Gb	EPS 12 ATEX 1430 X
B...	5	IECEX scheme	BV CPS	Ex ia IIC T6 Ga/Gb	IECEX EPS 15.0038 X

Table 7**Hermetically sealed Ex-Switches for use in Zone 1, float: Zone 0**

The type «e» (increased safety) housing is equipped with 1 or 2 Ex-d (flame-proof) microswitches, galvanically isolated with earthed encapsulation.

Enclosure type: IP66/IP67

Housing in sea water resistant die cast aluminium or optional stainless steel; prefix «5».

Cable gland thread: M20x1.5 (without cable gland)

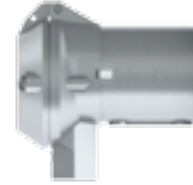

Type	Function	SIL	Temperature in °C		Connection diagram
			Operating	Ambient	
ZK.	SPDT Microswitch with silver contacts	SIL 1	-30 to +145	-45 to +80	
ZKK.	Dual SPDT Microswitches, galvanically isolated, with silver contacts	SIL 2	-30 to +145	-45 to +80	

Switching rating: 250 VAC, 5A 30 VDC, 5A
 50 VDC, 3 A
 75 VDC, 1 A
 125 VDC, 0.5A
 250 VDC, 0.25 A

Table 7.1**Submersible version IP68**

All modules in Table 7 are also available for submerged applications (IP68) to 100 m depth. The designation prefix is U3, U5, U11 etc. The designation 3, 5, 11 etc. specifies standard lengths of encapsulated cable in meters (longer cables are available).

All data in Table 7, except for temperature rating, remain unchanged. Housing: chromated.

Only permitted for certification designation 5 and 8!



Type	SIL	Temperature in °C	
		Operating	Ambient
ZU..K.	SIL 1	-30 to +80	-30 to +80
ZU..KK.	SIL 2	-30 to +80	-30 to +80

Table 8**Designation code and approval for hermetically sealed Ex-Switches, Type Z**

The designation number refers to the Certificate of Conformity and follows the module type. **Example: ZK8**



Designation	Type acc. to	Approval authority	Classification	Certificate
8	2014/34/EU	BV CPS	Ex ed IIC T5...T6 Ga/Gb	EPS 12 ATEX 1430 X
5	IECEX scheme	BV CPS	Ex ed IIC T5...T6 Ga/Gb	IECEX EPS 15.0038 X
1	EAC Ex	NANIO CCVE	Ga/Gb Ex ed IIC T6...T5 X	TC RU C-CH.ГБ05.B.00783

Table 9

High operating temperature

All basic modules in Table 7 are also available in a high temperature version with chromatised housing to IP66/IP67. The designation prefix is ZH or optional stainless steel; prefix is Z5H. Connection diagram see Table 7.



Type	Temperature in °C	
	Operating	Ambient
ZHK. / ZHKK.	0 to +380	0 to +80

Safety Integrity Level (SIL),
Type ZHK: SIL 1, Type ZHKK: SIL 2

Table 10

Low operating temperature

All basic modules in Table 7 are also available in a low temperature version with chromatised housing to IP66/IP67. The designation prefix is ZTD or optional stainless steel; prefix is Z5TD. Connection diagram see Table 7.



Type	Temperature in °C	
	Operating	Ambient
ZTDK. / ZTDKK.	-196 to +270	-45 to +80

Safety Integrity Level (SIL),
Type ZTDK: SIL 1, Type ZTDKK: SIL 2

Table 11

Flameproof switch modules

The following switch types are also available with a flameproof enclosure. The designation prefix is X. Enclosure Type IP66/IP67. Submersible version (XU) IP68. Housing material: sea water resistant die cast aluminium. Cable gland thread: M20x1.5. Switch rating: see page 44.



Type	Designation (see table 12)	Temperature in °C	
		Operating	Ambient
XA / XAA	8*, 5*, 1*	-40 to +330	-40 to +80
XU3A / XU3AA	8*, 5*, 1*	-30 to +80	-30 to +80
XB / XBB	8**, 5** 1**	-40 to +330	-40 to +80
XU3B / XU3BB	8**, 5** 1**	-30 to +80	-30 to +80
XI / XIN / XII	8**, 5** 1**	-30 to +220	-30 to +80
XIE9 / XINE9 / XIIE9	8**, 5** 1**	-50 to +220	-40 to +80

Notes: Flameproof Trimod Besta level switches are approved for use in Zone 1, float: Zone 0.

Safety Integrity Level (SIL): all types SIL 1
Types XAA, XU3AA, XBB, XU3BB: SIL 2

Table 11a

Connection diagram

Type

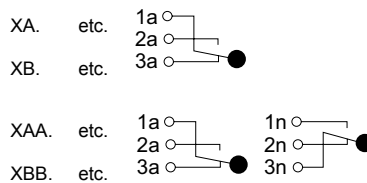

Type

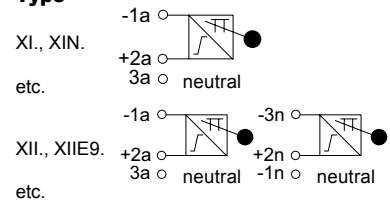

Table 12

Designation code and approval for flame proof switches

The designation number refers to the Certificate of Conformity and follows the module type.

Example: XA8.

Designation	Type acc. to	Approval authority	Classification	Certificate
8*	2014/34/EU	BV CPS	Ex de IIC T6 Ga/Gb	EPS 09 ATEX 1238 X
8**	2014/34/EU	BV CPS	Ex ia d IIC T6 Ga/Gb	EPS 09 ATEX 1238 X
5*	IECEX scheme	BV CPS	Ex de IIC T6 Ga/Gb	IECEX EPS 15.0037 X
5**	IECEX scheme	BV CPS	Ex ia d IIC T6 Ga/Gb	IECEX EPS 15.0037 X
1*	EAC Ex	NANIO CCVE	Ga/Gb Ex de IIC T6 X	TC RU C-CH.ГБ05.B.00783
1**	EAC Ex	NANIO CCVE	Ga/Gb Ex ia d IIC T6 X	TC RU C-CH.ГБ05.B.00783

Notes: Flameproof Trimod Besta level switches are approved for use in Zone 1, float: Zone 0.

Table 13**Pneumatic modules**

The pneumatic modules are described in detail on pages 14 to 16.
The housings are in sea water resistant aluminium. Pressure connections:
G 1/8" (BSPP) inside thread.



Type	Function	Connection diagram	Temperature in °C	
			Operating	Ambient
P	Pneumatic switch with ON/OFF 3/2 way valve. Input air pressure 0 to 10 bar		+1 to +250	+1 to +80
PV	Pneumatic switch with ON/OFF 3/2 way valve and drain valve for condensate removal. Input air pressure 0 to 10 bar		+1 to +250	+1 to +80
FP	Pneumatic switch with ON/OFF 3/2 way valve, 0 to 10 bar function checked, may be used in hazardous areas.		+1 to +250	+1 to +80
FPV	Pneumatic switch with ON/OFF 3/2 way valve, 0 to 10 bar function checked, may be used in hazardous areas with drain valve for condensate removal.		+1 to +250	+1 to +80
M	Pneumatic proportional control valve, input air pressure 1.4 bar (max. 10 bar). Output signal 0.2 to 1 bar (3-15 psi).		+1 to +250	+1 to +80
MV	Pneumatic proportional control valve and drain valve for condensate removal. Input air pressure 1.4 bar (max. 10 bar). Output signal 0.2 to 1 bar (3-15 psi).		+1 to +250	+1 to +80
FM	Pneumatic proportional control valve, input air pressure 1.4 bar (max. 10 bar). Output signal 0.2 to 1 bar (3-15 psi) function checked may be used in hazardous areas.		+1 to +250	+1 to +80
FMV	Pneumatic proportional control valve and drain valve for condensate removal. Input air pressure 1.4 bar (max. 10 bar). Output signal 0.2 to 1 bar (3-15 psi) function checked, may be used in hazardous areas.		+1 to +250	+1 to +80

Chromated housing

The types in Table 13 are also available with chroma-tized housing. Designation prefix is 2.

Example: 2P or F2M

Stainless steel housing

All switch modules in Table 13 are also available in stainless steel. The operating temperature range is increased to 400°C. Designation prefix is 5.

Example: 5MV or F5MV

Flange modules

The flange module is selected according to the required flange standard, nominal pressure rating (PN), nominal size (DN), type of gasket, properties of the medium and flange material. A basic distinction is made between flange modules for the Standard Range, the Industrial Range and the Plastic Range. The flange modules may be installed either horizontally or vertically.

Pressure equipment directive (PED) 97/23/EC:
For switches according to directive 97/23/EC add the letter «P» after flange name, e.g. A 01P 041

Table 14
Flange modules for the Standard Range

Type Standard flange

01 Square flange incl. gasket

Material	1.4408
Nominal pressure	PN 25, max. 25 bar up to 300°C
Flange facing	Raised face
Temperature range	-196 to 300°C
Counterflange	see page 38

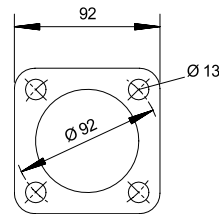

011 Round flange incl. gasket

Material	1.4571
Nominal pressure	PN 25, max. 25 bar up to 300°C max. 23 bar at 400°C
Flange facing	Raised face
Temperature range	-196 to 400°C
Counterflange	see page 38

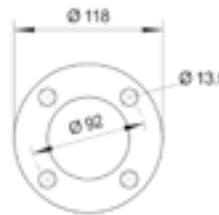

Type Special flanges

03 Round flange incl. gasket

Material	1.4571
Nominal pressure	PN 25, max. 25 bar up to 300°C max. 23 bar at 400°C
Flange facing	Raised face
Temperature range	-196 to 400°C

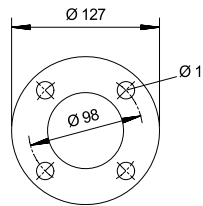

04 Round flange incl. gasket

Material	1.4571
Nominal pressure	PN 25, max. 25 bar up to 300°C max. 23 bar at 400°C
Flange facing	Raised face
Temperature range	-196 to 400°C

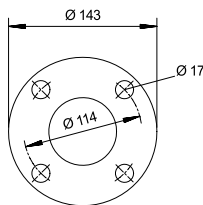

06 Round flange incl. gasket

Material	1.4571
Nominal pressure	PN 25, max. 25 bar up to 300°C max. 23 bar at 400°C
Flange facing	Raised face
Temperature range	-196 to 400°C

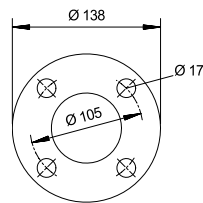

Key to type numbers

Switch module

Page 21

Flange module

Table 14 - 16

Float module

Page 32

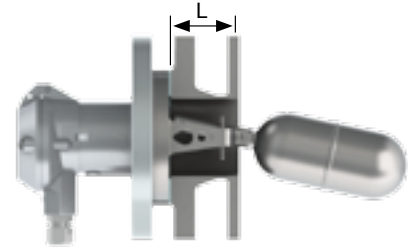
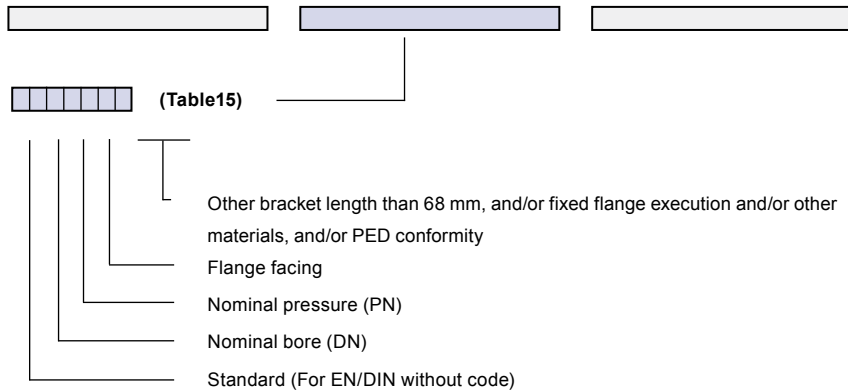

Important note:

Ensure that nozzle length L and diameter provide sufficient clearance for float movement. (See table 26, page 35.)

Flange modules for the Industrial Range acc. to EN/DIN, ANSI, BS, JIS

For economic reasons, the flange modules of the Industrial Range are manufactured in two different executions. The fixed flange for the most demanding requirements in respect of temperature range and corrosion resistance and the composite flange for best economy.

Fixed flange

Temperature range	-196 to +400°C
Material	1.4571
Options	1.4435 (316L), Hastelloy C
	If a fixed flange is required please consult us to select the correct type number.
	Type designation see table 15.

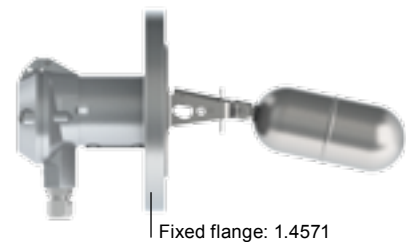

Composite flange

Temperature range	-10 to +400°C (EN/DIN)
	-29 to +400°C (ANSI)
Materials	Sealing unit 1.4571 (316Ti)
	Slip-on Flange Carbon steel P265GH zinc galvanized and passivated
Options	Sealing unit 1.4435 (316L), Hastelloy C
	Type designation see table 15.
	Slip-on Flange 13 CrMo 4-5 (high temp. steel)
	A 350-LF2 (low temp. steel)

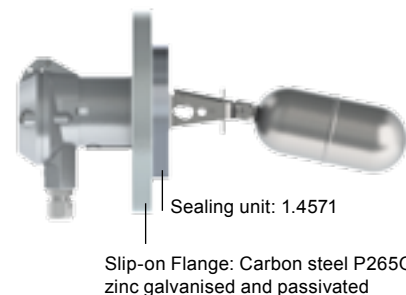

Table 15
Type of flange module according to EN 1092-1 (DIN 2501)

	PN 16	PN 40	PN 63	PN 100	PN 160	PN 250	PN 320
DN 65	21.	22.	23.	24.	25.	-	27.
DN 80	31.	32.	33.	34.	35.	36.	37.
DN 100	41.	42.	43.	44.	45.	46.	47.
DN 125	51.	52.	53.	54.	-	-	-
DN 150	61.	62.	63.	64.	-	-	-

Suffix for flange facings:

Raised face	type B1 (type C - DIN 2526)	C	PN 16 to 40
Raised face	type B2 (type E - DIN 2526)	E	PN 63 to 320
Male	type E (type V13 - DIN 2513)	V	PN 16 to 100
Groove	type D (type N - DIN 2512)	N	PN 16 to 160
Groove for metal joint	DIN 2696	L	PN 63 to 320

Example:

DIN-flange module, DN 65, PN 40, male: **22V**

Type of flange module according to ANSI B16.5

	cl. 150	cl. 300	cl. 400	cl. 600	cl. 900	cl. 1500	cl. 2500
DN 3"	131.	132.	-	134.	135.	136.	137.
DN 4"	141.	142.	143.	144.	145.	146.	147J
DN 5"	151.	152.	153.	154.	-	-	-
DN 6"	161.	162.	163.	164.	-	-	-

Suffix for flange facings:

Raised face	RF	R
Small male	SMF	M
Small tongue	STF	T
Small groove	SGF	G
Ring joint	RTJ	J

Example:

ANSI-Flange module DN 4", PN cl. 900, small groove: **145G**

Type of flange module according to BS 10

	Tbl. E	Tbl. F	Tbl. H	Tbl. K	Tbl. R	Tbl. S	Tbl. T
DN 3"	230R	231R	232R	233R	234R	235R	236R
DN 4"	240R	241R	242R	243R	244R	245R	246R
DN 5"	250R	251R	252R	253R	254R	-	-
DN 6"	260R	261R	262R	263R	264R	-	-

Suffix for flange facing:

Raised face	R
-------------	---

Example: BS-Flange module 4", Table K: **243 R**

Type of flange module according to JIS B 2220

	5K	10K	16K	20K	30K	40K	63K
DN 65	329.	320.	328.	321.	322.	323.	324.
DN 80	339.	330.	338.	331.	332.	333.	334.
DN 100	-	340.	-	341.	352.	343.	344.
DN 125	-	350.	-	351.	352.	353.	354.

Suffix for flange facings:

Large raised face:	R
Male:	M
Tongue:	T
Groove:	G

Example: JIS-Flange module DN 80A, PN 30K, groove: **332G**

Pressure/Temperature Diagram acc. to EN 1092-1 and ANSI B16.5

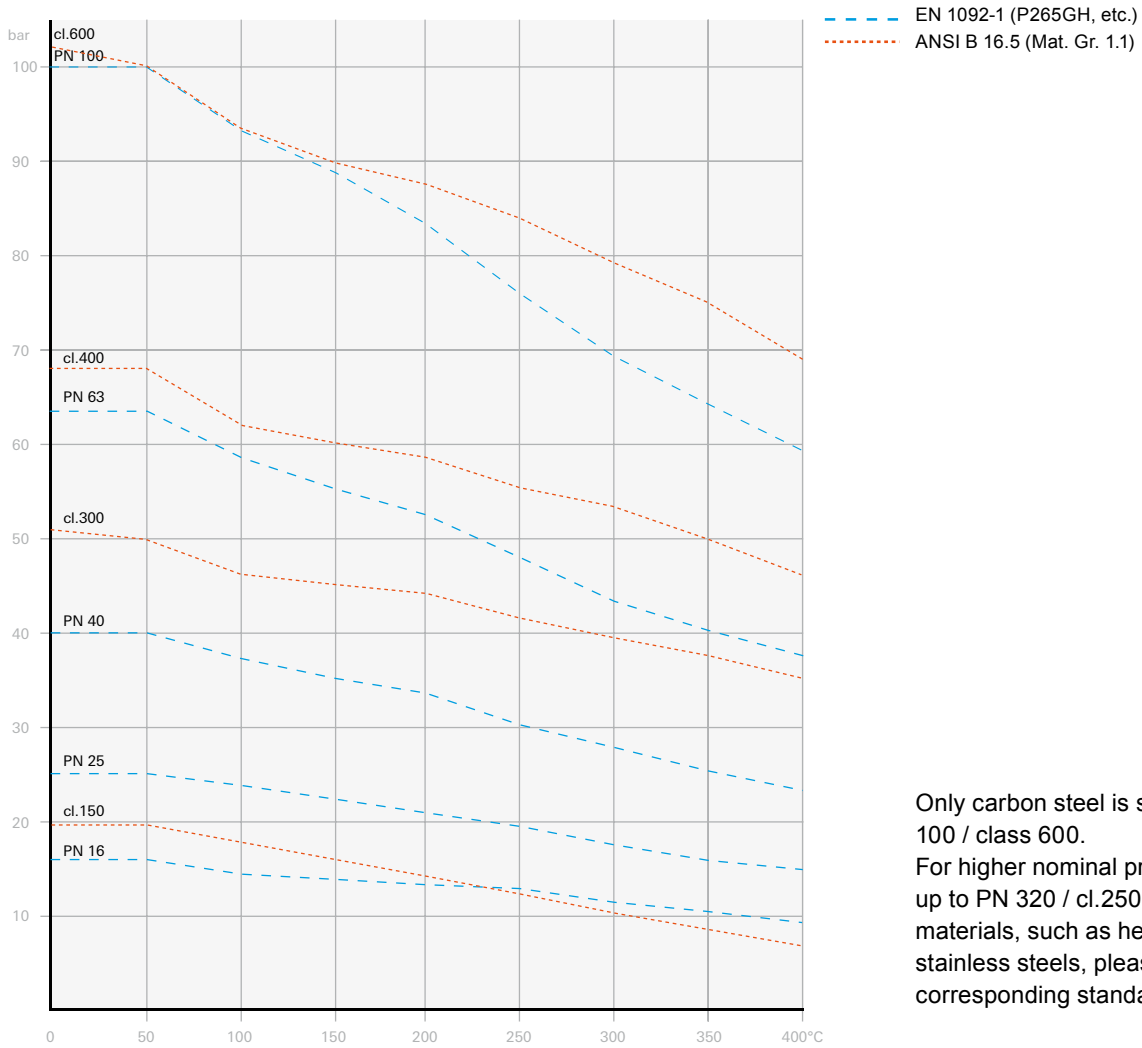

Only carbon steel is shown up to PN 100 / class 600.
For higher nominal pressure ratings up to PN 320 / cl.2500 and for other materials, such as heat resistant or stainless steels, please consult the corresponding standards.

Pressure/Temperature Diagram Plastics

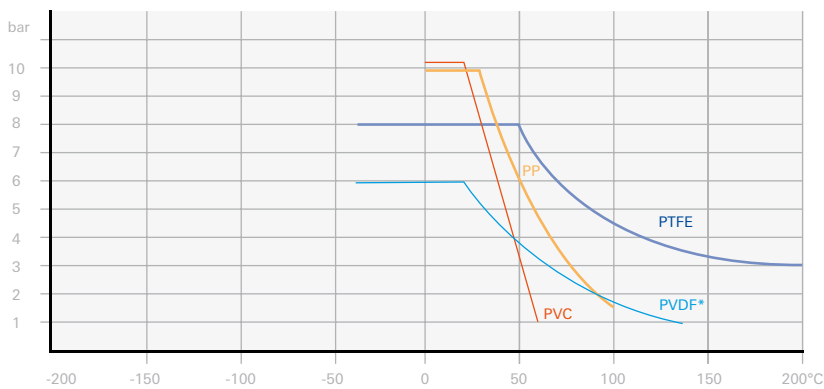

Flange modules for the Plastic Range acc. to EN/DIN, ANSI, BS, JIS

Wetted parts	PP (Polypropylene) or PTFE Sealing unit in PTFE with 25% GRP Option: sealing unit and pivot pin in Virgin-PTFE. Suffix: E104		
Slip-on Flange	PVC (for EN/DIN only) or P265GH (carbon steel), zinc galvanised and passivated Option: stainless steel for low temp. application		
Flange facing	Raised face		
Temperature range	PP Version with: PVC Slip-on Flange 0 to 60°C P265GH Slip-on Flange 0 to 100°C PTFE Version with: PVC Slip-on Flange 0 to 60°C P265GH Slip-on Flange -10 to 200°C (EN/DIN) P265GH Slip-on Flange -29 to 200°C (ANSI) stainless steel -196 to 200°C Slip-on Flange		
Pressure range	max. 10 bar		
Vacuum duty	The vacuum sealing unit is capable of operating to 0 bar absolute pressure, but this requirement must be specified in the purchase order. Suffix PTFE version: E19 (e.g. 302E19) Suffix PP version: E20 (e.g. 301E20)		

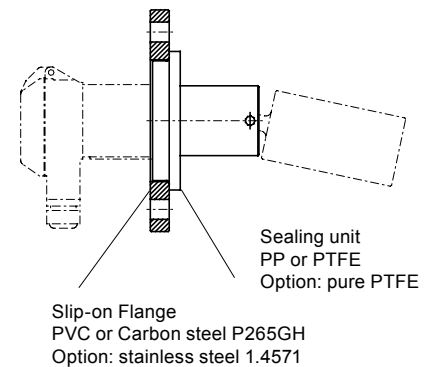
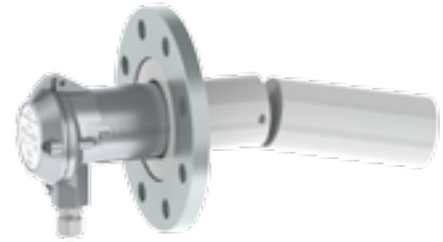
**Table 16****Type of flange module according to EN 1092-1 (DIN 2501) PN 10**

Material	DN 80	DN 100	DN 125	DN 150
PVC / PP	301	401	501	601
PVC / PTFE	302	-	502	-
P265GH / PP	303	403	503	603
P265GH / PTFE	304	404	504	604

Type of flange module according to ANSI B 16.5 PN cl. 150

Material	DN 3"	DN 4"	DN 5"	DN 6"
P265GH / PP	1313	1413	1513	1613
P265GH / PTFE	1314	1414	1514	1614

Type of flange module according to BS 10 PN Table E

Material	DN 3"	DN 4"	DN 5"	DN 6"
P265GH / PP	2303	2403	2503	2603
P265GH / PTFE	2304	2404	2504	2604

Type of flange module according to JIS B 2220 PN 10K

Material	DN 80	DN 100	DN 125	DN 150
P265GH / PP	3303	3403	3503	3603
P265GH / PTFE	3304	3404	3504	3604

Float modules

The float module should be selected acc. to the following parameters:

1. Function (alarm or control)
2. Minimum liquid density
3. Operating pressure
4. Operating temperature
5. Wetted material
6. Solids content
7. Mounting horizontally, vertically or in chamber
8. For Ex- or non Ex-applications
9. Liquids

Key to type numbers

Switch module

Page 21

Flange module

Page 27

Float module

Tables 17-30

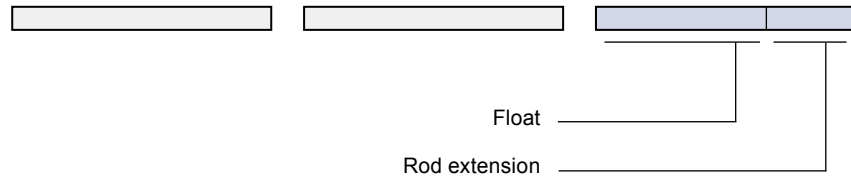

The most commonly used float modules are listed in Tables 17 to 24. The choice of modules is, however, much greater. If you do not find the float you require, please ask us.

Most float modules are also available in Hastelloy C. The type number changes e.g. from 04 to 404 etc. For exact type specification please ask.

NACE: stainless steel- and Hastelloy-floats are also available acc. to NACE Standard.

Table 17

Float modules with a 12 mm fixed differential

Float material: 1.4571 (SS316Ti equiv.)

Type	Float dimensions (mm) $\varnothing a \times b$	Bracket length (mm)	Overall length (mm)	Float travel (mm)	Counter-weight	Up to nominal pressure PN				Min. density (kg/dm ³)	Approved for hazardous areas	Rod extension (page 36)
						DIN bar	ANSI cl.	BS Table	JIS bar			
01	64 x 110	68	194	104	-	40	300	H	30	0.8	x	G1, G2, G3
04	64 x 142	68	226	117	-	40	300	H	30	0.7	x	G1, G2, G3
041	64 x 142	68	226	117	-	40	300	H	30	0.7	x	-
07	64 x 142	68	226	117	x	40	300	H	30	0.5	x	G1, G2
76	64 x 200	102	316	114	x	63	400	K	40	0.4	x	G1, G2
02	64 x 142	68	224	117	x	100	600	R	63	0.7	x	G1, G2
26	64 x 200	102	316	114	x	100	600	K	63	0.35	x	G1, G2
27	64 x 142	102	321	115	x	100	600	R	63	0.5	x	G1, G2
03	64 x 142	102	258	98	x	250	1500	T	63	0.75	x	G1, G2
031	64 x 142	142	431	115	x	250	1500	T	63	0.7	x	G1, G2
032	64 x 142	142	421	112	x	250	1500	T	63	0.5	x	G1, G2

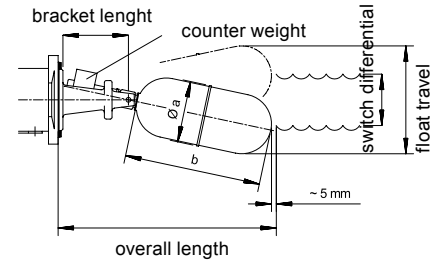

Rod extension see page 36



Table 18

Float modules with protective bellows and fixed operating differential 12 mm, float material: 1.4571 (SS316Ti equiv.)



Type	Float dimensions (mm) ø a x b	Bracket length (mm)	Overall length (mm)	Float travel (mm)	Counter-weight	Up to nominal pressure PN				Min. density (kg/dm ³)	Approved for hazardous areas	Rod extension (page 36)	Bellows material
						EN/DIN bar	ANSI cl.	BS Table	JIS Rating				
011	64 x 110	68	221	115	-	40	300	H	30K	0.8	x	G1, G2, G3	Perbunan
012	64 x 110	68	221	115	-	40	300	H	30K	0.8	-	G1, G2, G3	Silicon
013	64 x 110	68	221	115	-	40	300	H	30K	0.8	-	G1, G2, G3	FPM
051	64 x 142	68	253	129	-	40	300	H	30K	0.75	x	G1, G2, G3	Perbunan
052	64 x 142	68	253	129	-	40	300	H	30K	0.75	-	G1, G2, G3	Silicon
053	64 x 142	68	253	129	-	40	300	H	30K	0.75	-	G1, G2, G3	FPM
054	64 x 142	68	253	129	-	40	300	H	30K	0.75	-	G1, G2	PTFE
071	64 x 142	68	253	129	x	40	300	H	30K	0.5	x	G1, G2	Perbunan
072	64 x 142	68	253	129	x	40	300	H	30K	0.5	-	G1, G2	Silicon
073	64 x 142	68	253	129	x	40	300	H	30K	0.5	-	G1, G2	FPM
074	64 x 142	68	253	129	x	40	300	H	30K	0.5	-	G1, G2	PTFE
761	64 x 200	102	345	121	x	63	400	K	40K	0.45	x	G1, G2	Perbunan
762	64 x 200	102	345	121	x	63	400	K	40K	0.45	-	G1, G2	Silicon
763	64 x 200	102	345	121	x	63	400	K	40K	0.45	-	G1, G2	FPM
764	64 x 200	102	345	121	x	63	400	K	40K	0.45	-	G1, G2	PTFE

Perbunan = Buna (NBR)

Table 19

Float modules with adjustable differential for dual point control, float material: 1.4571 (SS316Ti equiv.)



Type	Float dimensions (mm) ø a x b	Bracket length (mm)	Overall length (mm)	Float travel (mm)	Operating differential (mm)	Counter-weight	Up to nominal pressure PN				Min. density (kg/dm ³)	Approved for hazardous areas	Remarks
							EN/DIN bar	ANSI cl.	BS Table	JIS Rating			
090	64 x 142	68	278	160 to 350	37 to 218	-	40	300	H	30K	0.8	x	
091	64 x 142	68	361	202 to 476	56 to 317	-	40	300	H	30K	0.75	x	switching differential see page 12
092	64 x 142	68	461	254 to 630	83 to 442	-	40	300	H	30K	0.75	x	
093	64 x 142	68	561	307 to 790	97 to 557	-	40	300	H	30K	0.75	x	
095	64 x 110	68	246	148 to 294	34 to 190	-	40	400	K	40K	0.9	x	

Table 20

Float modules for interface applications, horizontal mounting, float material: 1.4571 (SS316Ti equiv.)



Type	Float dimensions (mm) ø a x b	Bracket length (mm)	Overall length (mm)	Float travel (mm)	Counter-weight	Up to nominal pressure PN				Min. density (kg/dm ³)	Approved for hazardous areas	Min. density difference	Rod extension (mm)
						EN/DIN bar	ANSI cl.	BS Table	JIS Rating				
08T1	64 x 142	68	509	236	-	40	300	H	30K	0.75	x	0.1	300
			409	194	-	40	300	H	30K	0.75	x	0.14	200
			309	152	-	40	300	H	30K	0.8	x	0.22	100
28T1	64 x 142	102	541	174	x	100	600	R	63K	0.8	x	0.16	300
			441	147	x	100	600	R	63K	0.72	x	0.22	200
			341	120	x	100	600	R	63K	0.6	x	0.37	100

Table 21

Float modules with bellows for interface application, horizontal mounting, float material: 1.4571 (SS316Ti equiv.)



Type	Float dimensions (mm) ø a x b	Bracket length (mm)	Overall length (mm)	Float travel (mm)	Counter-weight	Up to nominal pressure PN				Min. density (kg/dm ³)	Approved for hazardous areas	Min. density difference	Rod length (mm)	Bellows material
						EN/DIN bar	ANSI cl.	BS Table	JIS Rating					
081T1	64 x 142	68	536	248	-	40	300	H	30K	0.8	x	0.1	300	Perbunan
			436	206	-	40	300	H	30K	0.8	x	0.13	200	Perbunan
			336	163	-	40	300	H	30K	0.9	x	0.19	100	Perbunan
082T1	64 x 142	68	536	248	-	40	300	H	30K	0.8	-	0.1	300	Silicon
			436	206	-	40	300	H	30K	0.8	-	0.13	200	Silicon
			336	163	-	40	300	H	30K	0.9	-	0.19	100	Silicon
083T1	64 x 142	68	536	248	-	40	300	H	30K	0.8	-	0.1	300	FPM
			436	206	-	40	300	H	30K	0.8	-	0.13	200	FPM
			336	163	-	40	300	H	30K	0.9	-	0.19	100	FPM
084T1	64 x 142	68	536	248	-	40	300	H	30K	0.8	-	0.1	300	PTFE
			436	206	-	40	300	H	30K	0.8	-	0.13	200	PTFE
			336	163	-	40	300	H	30K	0.9	-	0.19	100	PTFE

Perbunan = Buna (NBR)

Table 22

Plastic float modules with fixed operating differential 12 mm

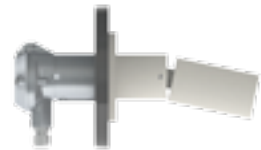

Type	Float dimensions (mm) ø a x b	Bracket length (mm)	Overall length (mm)	Float travel (mm)	Counter-weight	Up to nominal pressure PN				Min. density (kg/dm ³)	Material	Rod extension (page 36)
						EN/DIN bar	ANSI cl.	BS Table	JIS Rating			
98	64 x 150	68	240	132	-	8	150 ^{a)}	E ^{a)}	10K ^{a)}	0.75	PTFE	P1, V1, V2, V3
99	63 x 120	68	205	118	-	10	150 ^{b)}	E ^{b)}	10K ^{b)}	0.65	PP	K1, K2, K3

^{a)} Max. operating pressure 8 bar (test pressure 13 bar)

^{b)} Max. operating pressure 10 bar (test pressure 15 bar)

Table 23

Float modules for vertical mounting
Float material: 1.4571 (SS316Ti equiv.)

For alarm or pump control, see page 13.
Mounting information page 13.

Type	Float dimensions (mm) ø a x b	Bracket length (mm)	Overall length (mm)	Float travel (mm)	Counter-weight	Up to nominal pressure PN				Min. ^{f)} density (kg/dm ³)	Approved for hazardous areas
						EN/DIN bar	ANSI cl.	BS Table	JIS Rating		
140	120	68	1582	12 to 1340	x	16	150 ^{d)}	E ^{d)}	10K ^{d)}	0.45	-
141	120	68	3082	12 to 2840	x	16	150 ^{d)}	E ^{d)}	10K ^{d)}	0.45	-
145	120 x 164	68	1582	12 to 1300	x	25	150 ^{d)}	F ^{e)}	10K ^{e)}	0.45	x
146	120 x 164	68	3082	12 to 2800	x	25	150 ^{d)}	F ^{e)}	10K ^{e)}	0.45	x

^{d)} Max. operating pressure 16 bar (test pressure 24 bar)

^{e)} Max. operating pressure 25 bar (test pressure 38 bar)

^{f)} Minimum density for pump control 0.45 kg/dm³, for alarm 0.3 kg/dm³



Table 24**Plastic float modules for vertical mounting**

For alarm or pump control, if float module can not be mounted from inside use a flange module of at least DN 125 or 5".

Type	Float dimensions (mm) ø a x b	Bracket length (mm)	Overall length (mm)	Operating differential (mm)	Counter-weight	Up to nominal pressure PN				Min. density (kg/dm ³)	Material
						EN/DIN bar	ANSI cl.	BS Table	JIS Rating		
97	110 x 100	68	2000	12 to 1730	-	8	150*	E*	10K*	0.5	PP

* Max. operating pressure 10 bar (test pressure 15 bar)

**Table 25**

Maximum operating temperature for float modules

Float material	Temperature range in °C
Stainless steel 1.4571	-196 to +400
Polypropylene PP	0 to +100
Polytetrafluorethylene PTFE	-200 to +200
Polyamid-coated CrNiMo floats	-50 to +80
Halar-coated CrNiMo floats	-60 to +150

Bellow material	Temperature range in °C
Perbunan / Buna (NBR)	0 to +120
Silicon	-40 to +200
FPM	+10 to +200
Polytetrafluorethylene PTFE	-200 to +250

Note: When selecting a float module also consider the temperature rating of the switch- and flange module.

Table 26**Maximum length of connection flange, L**

To allow sufficient float clearance a maximum length «L» for the connection flange is shown in the following table according to the type of float module and the nominal flange size (dimensions in mm).

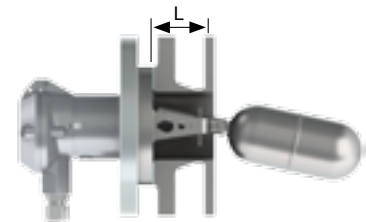

Nominal bore (flange)	Float module type													
	01	011 to 013	04 and 041	051 to 053	054	090	091	092	093	095	07	076	02	
DN 65 acc. to EN 1092-1 (DIN 2501)	80	105	80	105	70	70	70	70	70	70	80	110	80	
DN 80 acc. to EN 1092-1 (DIN 2501)	90	110	90	110	110	90	90	90	90	90	90	140	90	
DN 100 acc. to EN 1092-1 (DIN 2501)	∞	140	140	140	140	90	100	100	100	90	140	220	140	
DN 125 acc. to EN 1092-1 (DIN 2501)	∞	∞	∞	∞	∞	90	110	110	110	90	∞	∞	∞	
DN 150 acc. to EN 1092-1 (DIN 2501)	∞	∞	∞	∞	∞	90	120	120	120	90	∞	∞	∞	
3" accord. to ANSI B16.5	90	110	90	110	110	90	90	90	90	90	90	140	90	
4" accord. to ANSI B16.5	140	140	140	140	140	90	100	100	100	90	140	220	140	
5" accord. to ANSI B16.5	∞	∞	∞	190	190	90	110	110	110	90	∞	∞	∞	
6" accord. to ANSI B16.5	∞	∞	∞	∞	∞	90	120	120	120	90	∞	∞	∞	

Minimum bore diameter for above listed float modules: ø 65 mm.

Rod extensions

Where the float pivot needs to be protected from contaminated media or to provide an increased switching differential the float can be equipped with a rod extension.

Table 27
Type of rod extensions (Dimensions in mm)

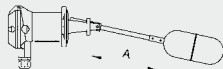
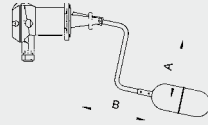
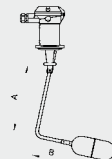
Rod extension material	To match float modules			
Stainless steel (CrNiMo)	Stainless steel (CrNiMo)	Type: G1 A max: 1000	Type: G2 A+B max: 1000 A/B: ≤ 4 A min: 100 B min: 100	*Type: G3 A+B max: 1000 A/B: ≤ 4 A min: 50 B min: 60
PP	PP	Type: K1 A min: 100 A max: 1000	Type: K2 A+B max: 1000 A min: 100 B min: 200	Type: K3 A+B max: 1000 A/B: ≤ 3 A min: 100 B min: 100
PVDF	PTFE	Type: V1 A min: 100 A max: 1000	Type: V2 A+B max: 1000 A min: 100 B min: 200	Type: V3 A+B max: 1000 A/B: ≤ 4 A min: 100 B min: 100
PTFE	PTFE	Type: P1 A min: 100 A max: 300	-	-

* Rod extension type G3 is available with 90° or 135° angle.

Since rod extensions add-on weight to the float, the minimum value for the density will change according to the following tables. Tables 28 to 30 list the minimum densities for float module 04 with extensions G1, G2 and G3 only. For other float modules and rod extensions with other dimensions or materials, please consult the factory.

Table 28
Minimum density for float module 04G1



Rod length A (mm)	100	200	300	400	500	600	700	800	900	1000
Min. density (kg/dm ³)	0.66	0.66	0.67	0.69	0.71	0.74	0.76	0.79	0.81	0.84

Table 29
Minimum density for float module 04G2 (kg/dm³)



A (mm)	100	200	300	400	500	600	700	800
B (mm)								
100	0.69	0.68	0.70	0.71	0.72	0.74	0.75	-
200	0.67	0.67	0.68	0.69	0.70	0.71	0.72	0.73
300	0.68	0.69	0.69	0.70	0.71	0.71	0.72	
400	0.70	0.70	0.71	0.71	0.72	0.73		
500	0.72	0.73	0.73	0.73	0.74			
600	0.74	0.75	0.75	0.75				
700	0.77	0.77	0.77					
800	0.79	0.80						
900	0.82							

Table 30
Minimum density for float module 04G3 (kg/dm³)



A (mm)	50-500	600	700	800
B (mm)				
50	0.71	-	-	-
100	0.69	-	-	-
200	0.68	0.68	0.68	0.68
300	0.69	0.69	0.69	
400	0.71	0.71		
500	0.73			
600	0.75			
700	0.77			
800	0.80			
900	0.82			
950	0.83			

Specification sheet

If you have a special requirement for a Trimod Besta level switch, please send us a completed copy of this specification sheet together with any relevant drawing etc. and we will respond with a quotation.

Liquid _____
 Density _____ kg/dm³
 Operating pressure _____ bar

Operating/ambient temperature _____ °C / _____ °C
 Tank material _____
 Tank measurement _____

Application

- High alarm
- Low alarm
- 2-point control
- Interface application
- Regulating (pneumatic)

Type of mounting

- Side mounted
- Top mounted
- In float chamber (by-pass)

Switch module type

Contact type
 Safety Integrity Level (SIL)
 Approval classification
 Cable gland
 Enclosure material
 Enclosure rating
 Remarks

Electric

- SPDT
- Silver
- SIL 1
- Ex ed IIC T6...T5 (Hermetically sealed)
- M20 x 1.5
- Die cast aluminium
- IP65
- 2 x SPDT
- Gold plated
- SIL 2
- Die cast aluminium, chromated
- IP66/IP67

Electronic

- I
- IN
- Ex ia IIC T6...T2 (Intrinsically safe circuits)
- 3/4" NPT
- IP68, cable length _____

Pneumatic

- On/Off
- proportional
- Ex de IIC T6 (Flameproof)
- Stainless steel

Flange module type

Flange type
 DN/PN
 Wetted parts material
 Slip-on Flange material
 Remarks

- Square flange 92 x 92
- ANSI
- CrNiMo
- Carbon steel P265GH zinc galvanized and passivated
- Fixed Flange
- DN _____
- PP
- Slip-on Flange
- PN _____
- PTFE

Seal type

 Other

 Other

Float module type

Float material
 Differential
 Bellows
 Remarks

- CrNiMo
- Fixed 12 mm
- Perbunan (NBR)
- Hastelloy C
- Variable between _____
- Silicon
- FPM
- PP
- PTFE

Options

Float rod extension
 Counterflanges
 Test actuators
 Test certificates
 Tag No.

- G1
- Carbon steel
- CrNiMo / FPM
- T-100 (2.2)
- G2
- CrNiMo
- T-101 (3.1)
- G3
- CrNiMo / EPDM
- T-110 (test certificate)
- Dim. A _____ mm
- Dim. B _____ mm

Accessories

Counterflanges with and without test actuator

The simplest method of installing any Trimod Besta level switch of the Standard Range and the Compact Switch with a square flange, is to use our standard weld-on counterflanges. There are carbon steel (P250GH) and stainless steel (1.4404) versions in two different lengths available. The test actuator allows a periodic manual function check of the level switch in operating status. The function of the switching element (microswitch, proximity switch, pneumatic valve) and movement of the float can be tested.

Counterflange

not for use with the test actuator

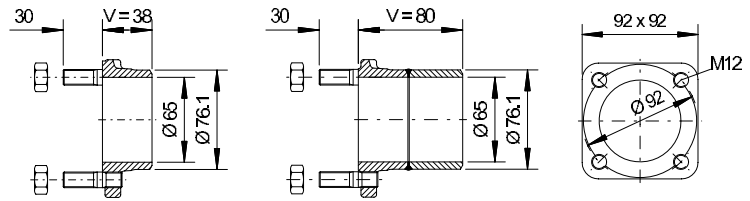

Type 2829.1 & 2831.3

Type 2829.1V80 & 2831.3V80

Table 31

Type	Flange length	Flange material	Stud material	Stud length
2829.1	V = 38 mm	P250GH	5.8	30 mm
2831.3	V = 38 mm	1.4404	A2	30 mm
2829.1V80*	V = 80 mm	P250GH	5.8	30 mm
2831.3V80*	V = 80 mm	1.4404	A2	30 mm

Counterflange

for use with the test actuator
(type 2382 & 2383)

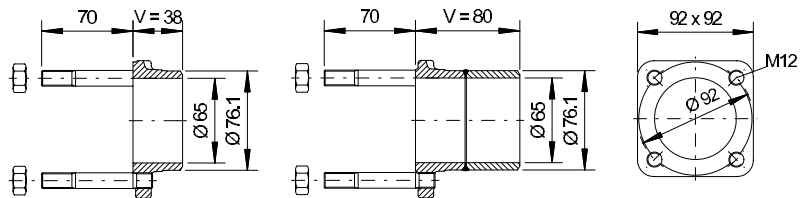

Type 2829.2 & 2831.4

Type 2829.2V80 & 2831.4V80

Table 32

Type	Flange length	Flange material	Stud material	Stud length
2829.2	V = 38 mm	P250GH	5.8	70 mm
2831.4	V = 38 mm	1.4404	A2	70 mm
2829.2V80*	V = 80 mm	P250GH	5.8	70 mm
2831.4V80*	V = 80 mm	1.4404	A2	70 mm

*Important: Not for use in applications on top of the tank.

Counterflange with test actuator

Important: Positioning of counterflanges with G 3/8" thread for test actuator.

If the level switch is used for high alarm the thread has to look upwards. For a low level alarm, the thread has to look downwards.

Counterflange V = 50 mm with test actuator

Type	Flange material	Stud material	Test actuator material	O-Ring
2865	P250GH	5.8	1.4305/1.4404	FPM
2866	P250GH	5.8	1.4305/1.4404	EPDM
2868	1.4404	A2	1.4305/1.4404	FPM
2869	1.4404	A2	1.4305/1.4404	EPDM

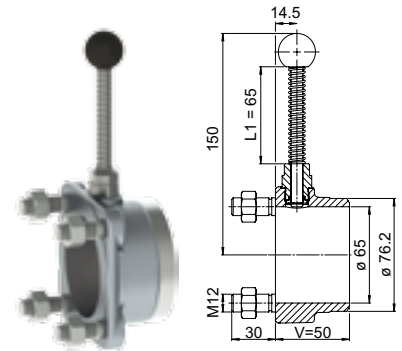

Test actuator

The test actuators 2382 and 2383 can be used, if the tank is already equipped with a counterflange, type 2829.2, 2831.4, 2829.2V80 or 2831.4V80.

Important: Not for use with the Compact Switch.

Table 33

Type	Test actuator material	O-Ring material	Temperature range in °C	Operating pressure in bar
2382	1.4305/1.4404	FPM	0 to 150	-1 to 25
2383	1.4305/1.4404	EPDM	-30 to 150	-1 to 25

Test actuators are supplied with flat gaskets.



Table 34

Application	Use as high (HA) or low (LA) alarm	Mounting position
Checking switch function and float movement under operating conditions (PS = -1 to 25 bar)	HA	
	LA	

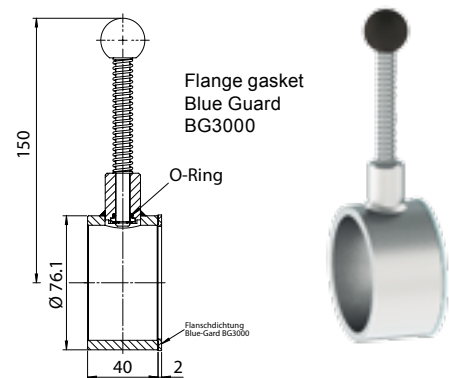

Temperature range: Table 31 to 34:

- Counterflange
 - Material P250GH: -10 to 300°C
 - Material 1.4404: -196 to 400°C
- Test actuator
 - with FPM O-Ring: 0 to 150°C
 - with EPDM O-Ring: -30 to 150°C

Operating pressure: -1 to 25 bar

Important: For use of the counterflange on top of the tank (vertical switch) please contact us for correct application.

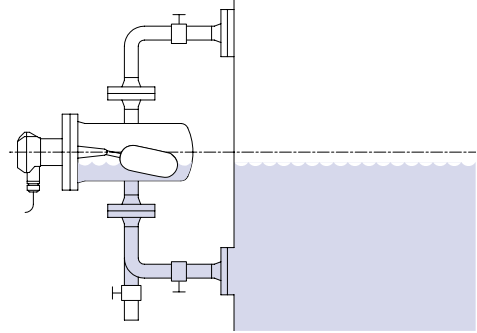

Float chambers

Wherever it is not possible or desirable to install float switches directly onto a vessel, horizontal Trimod Besta level switches can be mounted externally in a float chamber. This type of installation allows functional checks and servicing to be carried out without interrupting operation, provided that isolation and drain valves are included in the process connections.

Float chambers may be divided into 2 groups.

Standard chambers PN 25

In various steel qualities and configurations with process connection acc. to EN/DIN or ANSI.

For use with the Trimod Besta level switches from the standard range with:

Square flange type: 01 or

Round flange type: 011

Industrial chambers up to PN 320 acc. to EN/DIN or PN cl. 2500 acc. to ANSI

In various steel qualities and configurations with switch- and process connections acc. to EN/DIN or ANSI.

For use with the Trimod Besta level switches from the industrial range with EN/DIN-flanges DN 65 or ANSI-flanges DN 3".



Table 37
Standard chambers PN 25

Types	According to figures A to H
Process connections	DN 25, 50 in accordance with EN/DIN DN 1", 2" in accordance with ANSI
Material	Carbon steel High temperature steel CrNi steel CrNiMo steel
Flange facing of process connections	in accordance with EN 1092-1 (DIN 2526) and ANSI B16.5
Options	Special dimensions Vent and drain connection Long studs for mounting a test actuator Float chambers for low temperature applications Float chambers with max. hardness of HRC 22 in accordance with NACE

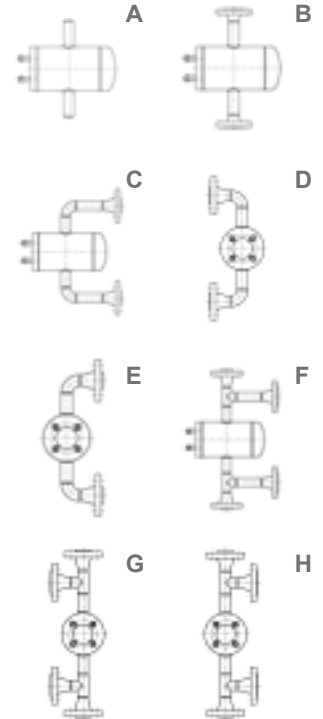
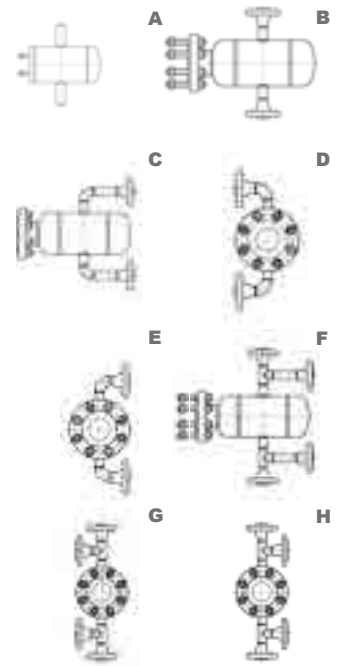

Table 38
Industrial chambers PN 40 to 100 and ANSI PN cl. 150 to 600

Types	According to figures A to H
Process connections	DN 25, 50 in accordance with EN/DIN DN 1", 2" in accordance with ANSI
Material	Carbon steel High temperature steel CrNi steel CrNiMo steel
Flange facing of process connections	in accordance with EN 1092-1 (DIN 2526) and ANSI B16.5
Options	Special dimensions Vent and drain connection Chambers up to PN 320 in accordance with EN/DIN, PN cl. 2500 with ANSI Float chambers for low temperature applications Float chambers with max. hardness of HRC 22 in accordance with NACE



For float chambers in Tables 37 and 38, the following options, tests and documentation are available:

Test report in accordance with EN 10204-2.2

Inspection certificate in accordance with EN 10204-3.1

Non destructive testing such as ultrasonic, X-ray, dye penetrant or magnetic particle examination

Material testing including charpy, tensile and hardness

Design-examination for PED in accordance with 2014/68/EU

Coatings

Trimod Besta Level Switches in hazardous areas

For level monitoring in hazardous areas, the following Trimod Besta level switches are available:

Flameproof Trimod Besta Level Switches

Flameproof Trimod Besta level switches are designed in accordance with ATEX, IECEx and EAC Ex standards and are tested and approved.



Flameproof version

Protection classifications:

Ex de IIC T6 Ga/Gb	for switch modules XA..8 etc.	EPS 09 ATEX 1238 X
Ex ia d IIC T6 Ga/Gb	for switch modules XB..8, XI..8, XIE9..8 etc.	EPS 09 ATEX 1238 X
Ex de IIC T6 Ga/Gb	for switch modules XA...5 etc.	IECEX EPS 15.0037 X
Ex ia d IIC T6 Ga/Gb	for switch modules XB...5, XI...5, XIE9...5 etc.	IECEX EPS 15.0037 X
Ga/Gb Ex de IIC T6 X	for switch modules XA..1 etc.	TC RU C-CH.ГБ05.В.00783
Ga/Gb Ex ia d IIC T6 X	for switch modules XB..1, XI..1, XIE9..1 etc.	TC RU C-CH.ГБ05.В.00783

For type designations or details see page 25.

Hermetically sealed Trimod Besta Level Switches

These switches are available in three versions.

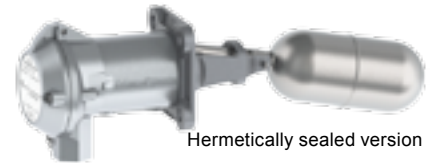

Hermetically sealed version

Protection classifications:

Ex ed IIC T5...T6 Ga/Gb	for switch modules Z..8 etc.	EPS 12 ATEX 1430 X
Ex ed IIC T5...T6 Ga/Gb	for switch modules Z..5 etc.	IECEX EPS 15.0038 X
Ga/Gb Ex ed IIC T6...T5 X	for switch modules Z..1 etc.	TC RU C-CH.ГБ05.В.00783

For type designations or details see page 24.

Trimod Besta Level Switches for use in intrinsically safe installations

Level switches with proximity switches acc. to NAMUR (type range I.. and IE9.. etc.) or micro switches with gold plated contacts (type range B) are for connection to intrinsically safe circuits and approved, depending on national regulations, for Zone 1, floats in Zone 0.



For intrinsically safe installation

Protection classifications:

Ex ia IIC T6...T2 Ga/Gb	for switch modules I..8, IE9..8 etc.	EPS 12 ATEX 1430 X
Ex ia IIC T6 Ga/Gb	for switch modules B...8 etc.	EPS 12 ATEX 1430 X
Ex ia IIC T6...T2 Ga/Gb	for switch modules I...5, IE9...5 etc.	IECEX EPS 15.0038 X
Ex ia IIC T6 Ga/Gb	for switch modules B...5 etc.	IECEX EPS 15.0038 X

For type designations or details see pages 21 and 23.

Pneumatic Trimod Besta Level Switches and Level Controllers

Pneumatic level switches of the type ranges FP and FM are approved for installation in Zone 1, floats in Zone 0.

For type designations and details see page 26.



Pneumatic version

Mode of installation

All Trimod Besta level switches of the Ex-proof range may be side or top mounted.

Micro- and proximity switches

Additional information to the switch module descriptions on pages 21 to 26.

Microswitches of the switch module range type A

The manufacturers data (Johnson Electric) is shown in Table 39. However, these switches have been tested by ESTI (Swiss Federal Inspectorate for High Current), as follows: () inductive loads:

Type A: 250 VDC, 0.5 (0.15) A 250 VAC, 5 A
 Type AE26: 440 VDC, 0.3 A 380 VAC, 5 (1) A

Microswitches of the switch module range type XA...8, XA...5, XA...1

Electrical data acc. to Type-examination acc. to ATEX, IECEx and EAC Ex.
 250 VDC, max. 0.25 A 250 VAC, max. 5 A

Microswitches of the switch module range type B

The silver contacts of these microswitches are gold plated and intended for use in intrinsically safe circuits. Though the max. rating can be as per Table 39, please be aware, that the gold plating will be permanently damaged when used for values greater than applicable for intrinsically safe circuits.

Microswitches of the switch module range type B...8, B...5

Electrical data acc. to Type-examination acc. to ATEX and IECEx.
 Gold plated contacts
 max. 30 VDC, max. 300 mA, max. 0.12 VA
 $Li \approx 0 \mu\text{H}$, $Ci \approx 0 \text{ nF}$

Microswitches of the switch module range type XB...8, XB...5, XB...1

Electrical data acc. to Type-examination acc. to ATEX, IECEx and EAC Ex.
 Gold plated contacts
 max. 30 VDC, max. 300 mA, max. 0.12 VA
 $Li \approx 0 \mu\text{H}$, $Ci \approx 0 \text{ nF}$

Microswitches of the switch module range type Z...8, Z...5, Z...1

Electrical data acc. to Type-examination acc. to ATEX, IECEx and EAC Ex.
 250 VDC, 0.25 A 250 VAC, 5 A
 125 VDC, 0.5 A
 75 VDC, 1 A
 50 VDC, 3 A
 30 VDC, 5 A

Table 39

Voltage V	Tungsten Lamp Load			
	Resistive Load A	NC A	NO A	Inductive Load A
AC to 250	5	0.5	0.5	5
DC to 30	5	1.5	1.0	5
DC to 50	3	0.8	0.8	2.5
DC to 75	1	0.6	0.6	0.5
DC to 125	0.5	0.5	0.5	0.07
DC to 250	0.25	0.25	0.25	0.03

Only approximate values can be given for the allowable charge of gold contacts. These must be reduced under unfavourable impedance conditions. The product of current and voltage should not exceed 0.12 VA. The current should move at $\leq 400 \text{ mA}$ and voltage at $\leq 30 \text{ V}$. For alternating currents these values must be interpreted as maximum values.

Inductive proximity switches acc. to NAMUR/EN 60947-5-6

The switch modules of the type ranges I and IE9 are especially suitable for applications in hazardous areas*. The switching element, an inductive proximity sensor (Pepperl+Fuchs) contains only the oscillator. The signal is processed by a remote mounted relay amplifier unit as shown in the connection diagram. *(ATEX/IECEX)

Connection diagram

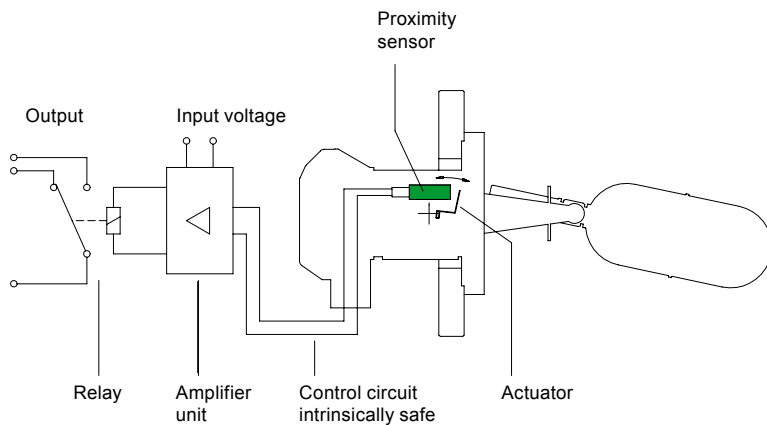

Electrical data of inductive proximity switches	
Nominal voltage U_N	8.2 VDC $\pm 5\%$
Operating voltage U_B	5 to 25 VDC
Current consumption	
sensor uncovered	≥ 2.2 mA
sensor covered	≤ 1 mA
Control line: resistance	$\leq 50 \Omega$

Special self checking failsafe features

If the switch is connected for maximum current/voltage in the non alarm state the circuit can be monitored constantly for line and/or instrument failure to initiate operation of a safety shutdown.

The sensor circuit of the switch modules IE9, INE9, and IIE9, are also self checking and approved for safety circuits (TÜV tested). With these sensors, automatic switching to the alarm state in the event of component failure is guaranteed. When specifying a safety circuit, approved amplifiers and transistor relays must be incorporated.

For use in hazardous areas the following data should be observed for Trimod Besta level switches with inductive proximity sensors:

Type I, IN, II:	$U_{max.}$ 16 VDC	$L_i \leq 50 \mu H$	$C_i \leq 45$ nF
Type IE9, INE9, IIE9:	$U_{max.}$ 16 VDC	$L_i \leq 150 \mu H$	$C_i \leq 50$ nF

Trimod'Besta

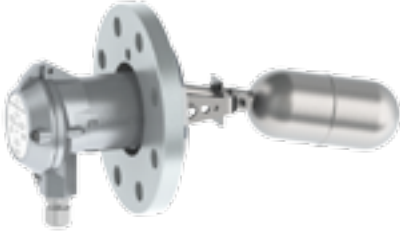

Limit switches with electric, electronic and pneumatic switch elements. Numerous shipbuilding and explosion proof approvals and registrations.

COMPACT SWITCH



Side mounted switches for high or low alarm duties. With Lloyds Register Approval.

Senlux'Besta



Opto-electronic level sensors for horizontal and vertical installation. Sensitivity adjustable via potentiometer.

Bachofen AG
Ackerstrasse 42
CH-8610 Uster
Switzerland
Phone +41 44 944 11 11
Fax +41 44 944 12 33
info@trimodbesta.com
www.trimodbesta.com

Homepage
Find your local sales and service partner under
www.trimodbesta.com

Quality Management
The Bachofen quality management system acc. to
ISO 9001 was established in 1994.

Registered Trade Marks
Trimod and Besta are registered trade marks of
Bachofen AG, Switzerland.